

AVTEK

ST1200



Uchwyt ścienny do projektora

Projector Wall Mount

Projektor Wandhalterung

Support mural pour projecteur

Držák širokoúhlého projektoru

Držiak na širokouhlý projektor

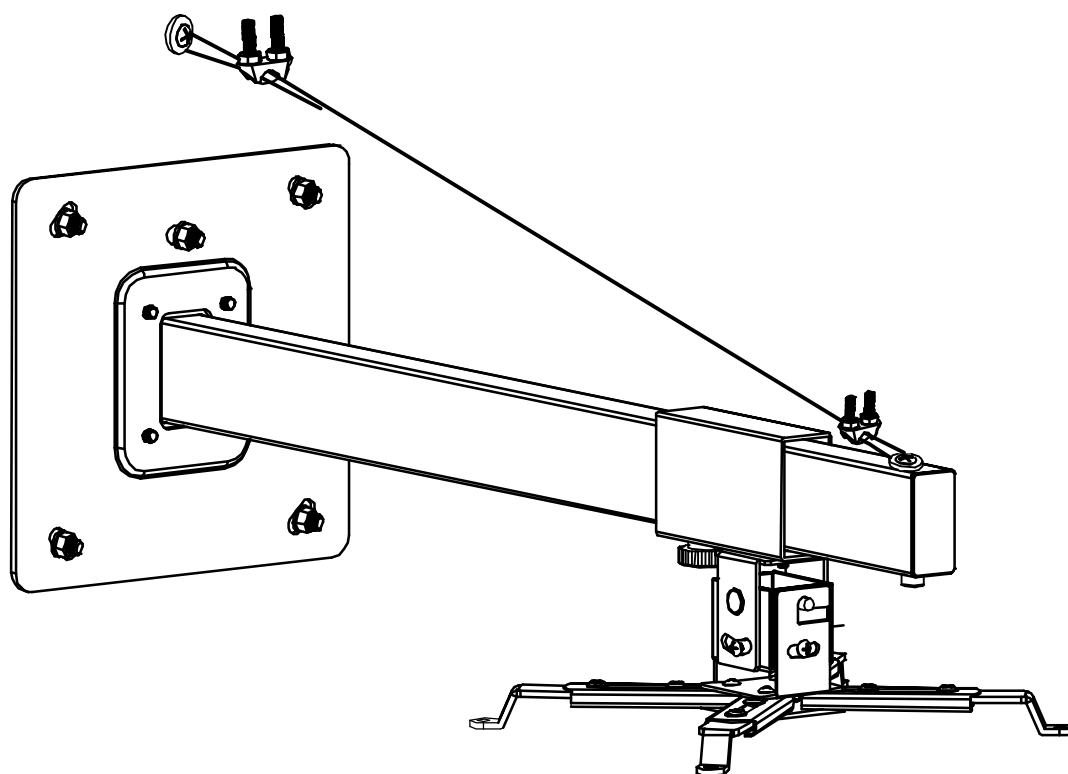







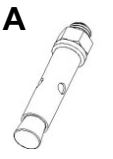
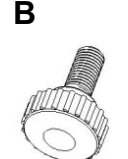

PL	Instrukcja montażu	1
EN	Installation instruction.....	3
DE	Gebrauchsanweisung	5
FR	Mode d'emploi	7
CZ	Návod k montáži	9
SK	Návod na montáž	11

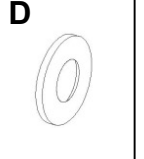
Uchwyt do projektora szerokokątnego - instrukcja montażu

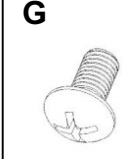
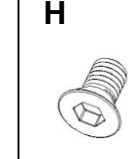
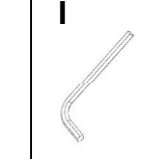
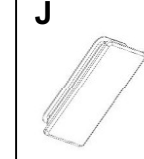
Model: ST1200

Lista części

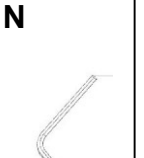
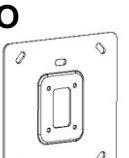
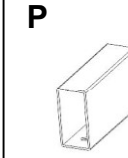
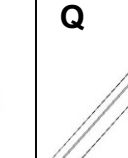
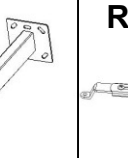
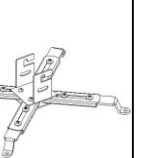
 M8X60 (X5)	 X1	 S=5mm (X1)	 PW6.2X13X1(X1)	 M6X12 (X1)	 M4X8 (X6)	 M5X9 (X2)	 M5X10 (X4)	 S=3mm (X1)	 X1
 X2	 M3X8 (X4)	 PW3.2X10X1(X4)	 S=2.5mm (X1)	 X1	 X1	 X1	 X1	 X1	

Instalacja







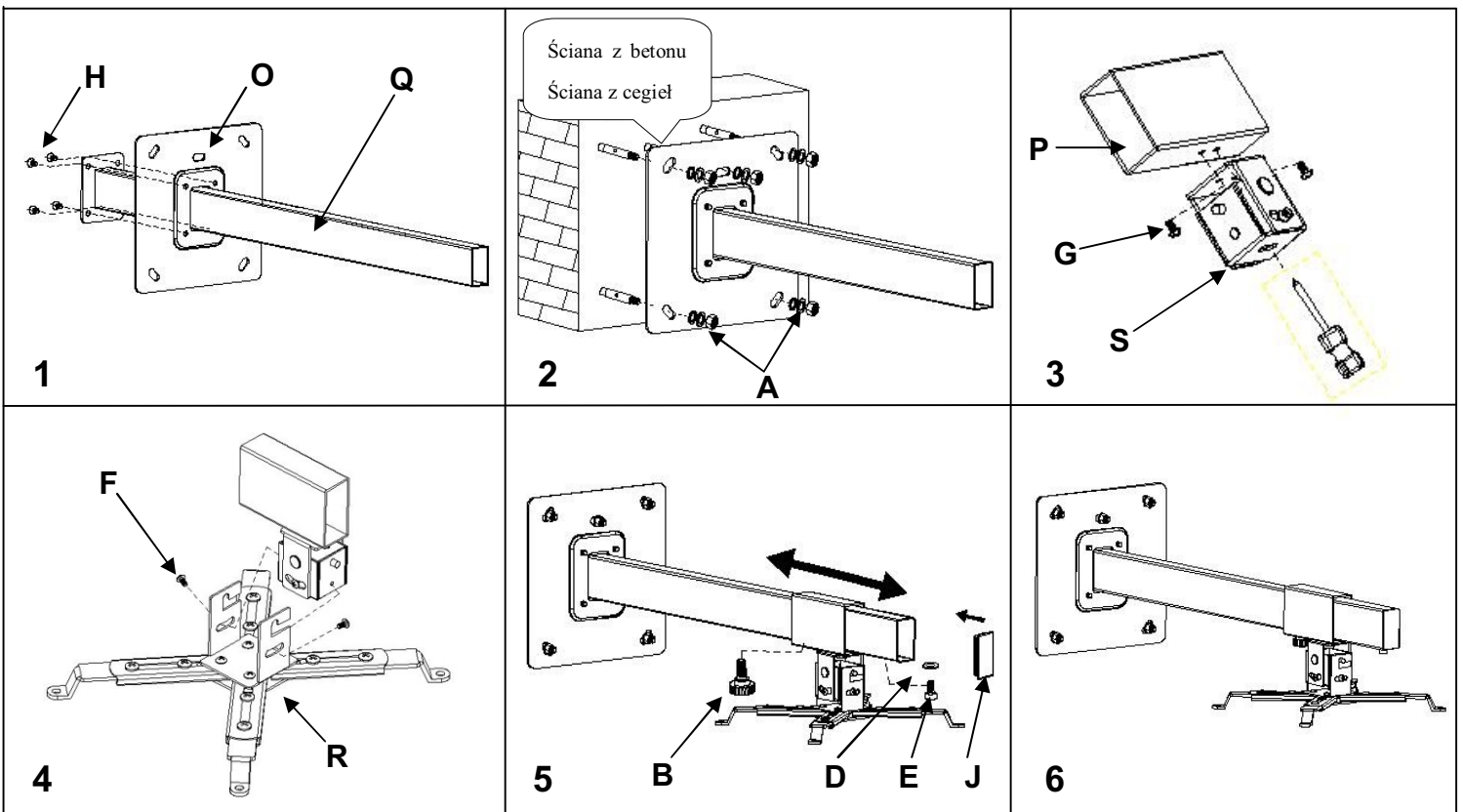



Uwaga!

Ten uchwyt do projektora szerokokątnego wolno instalować wyłącznie na murze ceglany lub betonowy przy użyciu załączonych przez producenta wkrętów.



Uchwyt do projektora szerokokątnego (linka odciążająca)

Lista części

A  M5X9(X1)	B  P.W5.2X16X2.2(X2)	C  M4X3(X4)	D  X2	E  M4(X2)	F  X1	G  X1	H  M4X45(X1)	I  S=6.8
-----------------------------------------------------------------------------------------------------------	--------------------------------------------------------------------------------------------------------------------	-----------------------------------------------------------------------------------------------------------	-----------------------------------------------------------------------------------------------------	---------------------------------------------------------------------------------------------------------	------------------------------------------------------------------------------------------------------	-------------------------------------------------------------------------------------------------------	--------------------------------------------------------------------------------------------------------------	----------------------------------------------------------------------------------------------------------

Instalacja



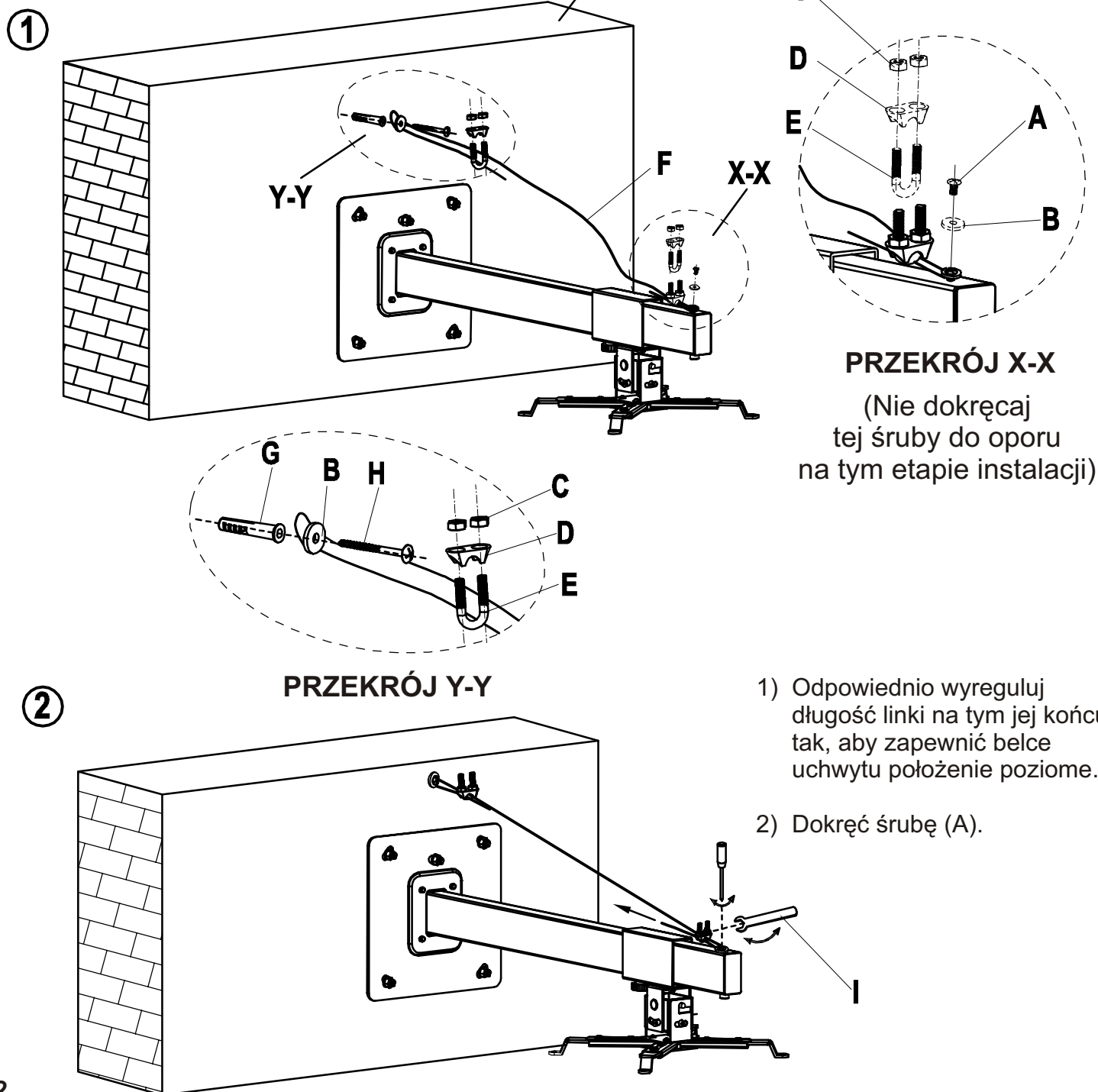





Montaż wyłącznie na murze betonowym lub ceglany

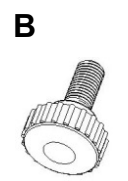

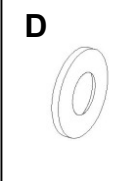
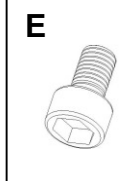
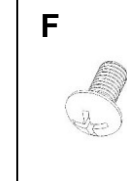
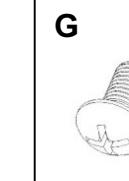
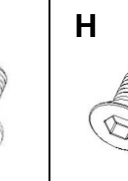
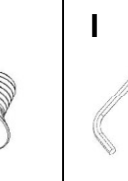
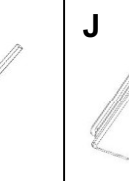
Short Throw Projector Mount Installation Instruction

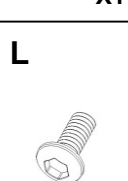
Model: ST1200

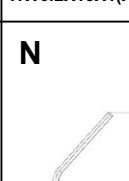
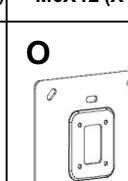
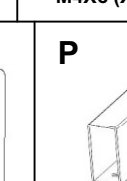
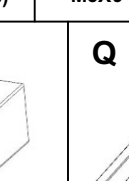
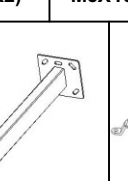
Parts List

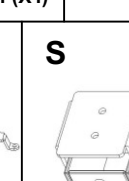
 M8X60 (X5)	 X1	 S=5mm (X1)	 PW6.2X13X1(X1)	 M6X12 (X1)	 M4X8 (X6)	 M5X9 (X2)	 M5X10 (X4)	 S=3mm (X1)	 X1
 X2	 M3X8 (X4)	 PW3.2X10X1(X4)	 S=2.5mm (X1)	 X1	 X1	 X1	 X1	 X1	 X1

Installation







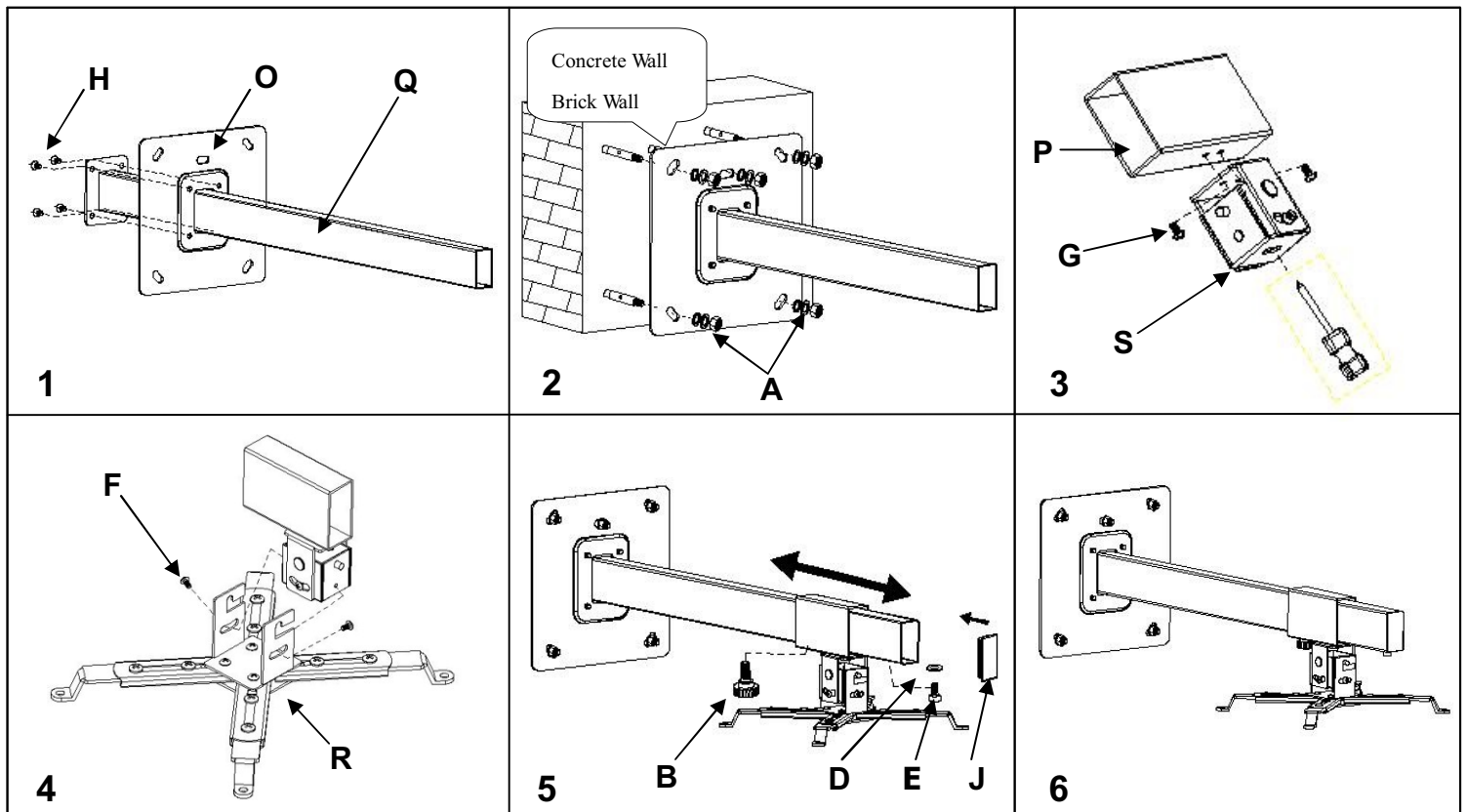



Notice!

This short throw projector mount should only be installed on concrete or brick wall with provided screws.



Short Throw Projector Mount (Wire Installation)

Parts List

A  M5X9(X1)	B  P.W5.2X16X2.2(X2)	C  M4X3(X4)	D  X2	E  M4(X2)	F  X1	G  X1	H  M4X45(X1)	I  S=6.8
-----------------------------------------------------------------------------------------------------------	--------------------------------------------------------------------------------------------------------------------	-----------------------------------------------------------------------------------------------------------	-----------------------------------------------------------------------------------------------------	---------------------------------------------------------------------------------------------------------	------------------------------------------------------------------------------------------------------	-------------------------------------------------------------------------------------------------------	--------------------------------------------------------------------------------------------------------------	----------------------------------------------------------------------------------------------------------

Installation

Brick Wall or concrete wall only

①

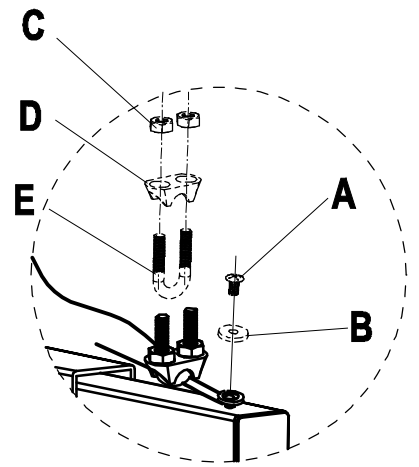
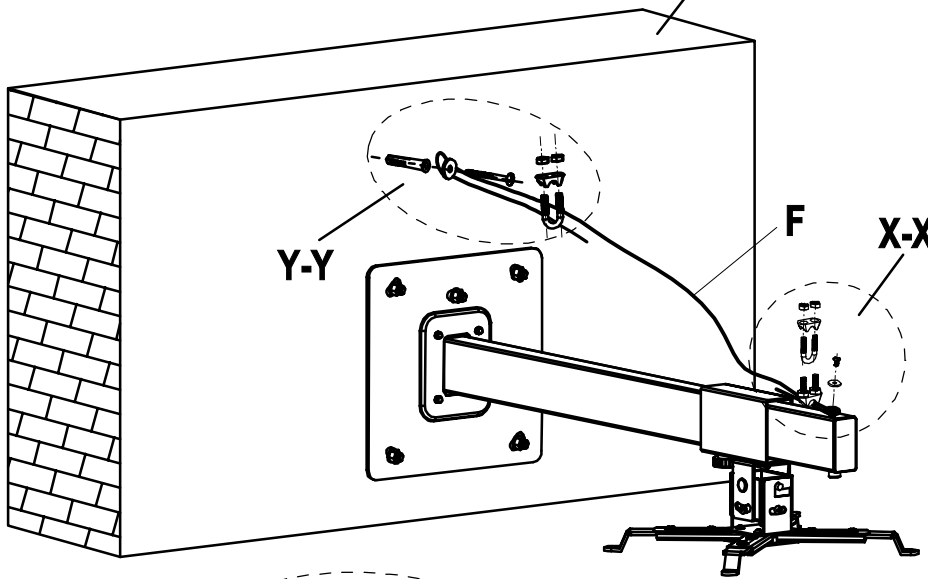

X-X VIEW

(Do not fully tighten this screw at this moment)

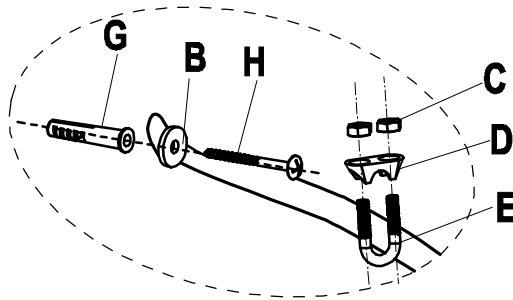

Y-Y VIEW

1) Adjust the wire at this end to make sure the mount is in horizontal level.

2) Tighten the screw (A).



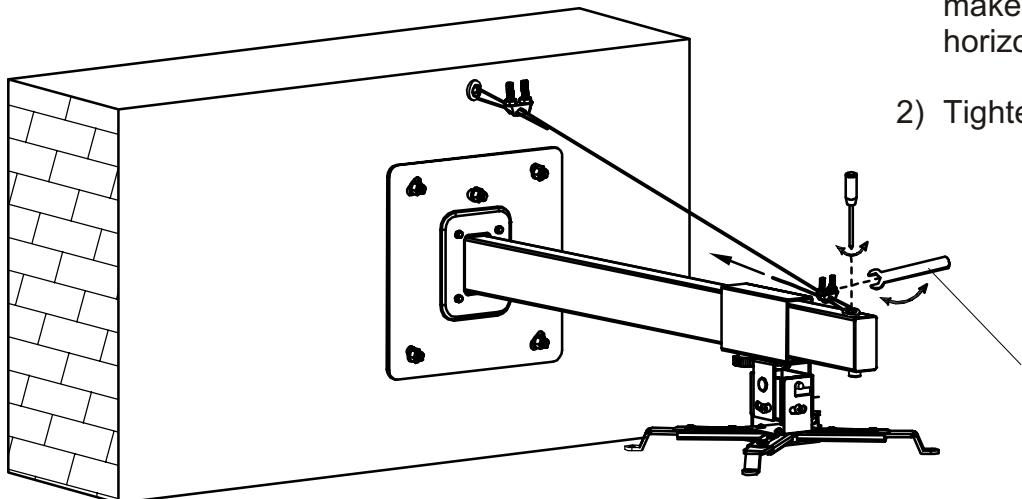







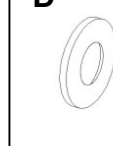
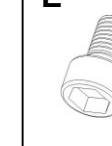

②

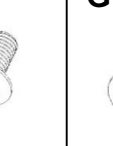
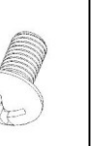
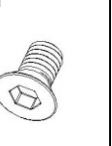

Kurz-Distanz Projektor Wandhalterung Gebrauchsanweisung

Model: ST1200

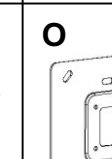
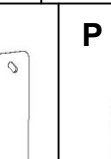
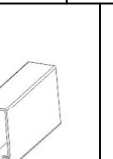
Teilliste

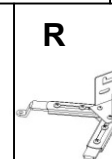
A  M8X60 (X5)	B  X1	 S=5mm (X1)	D  PW6.2X13X1(X1)	E  M6X12 (X1)	F  M4X8 (X6)	G  M5X9 (X2)	H  M5X10 (X4)	I  S=3mm (X1)	J  X1
K  X2	L  M3X8 (X4)	M  PW3.2X10X1(X4)	N  S=2.5mm (X1)	O  X1	P  X1	Q  X1	R  X1	S  X1	

Installation







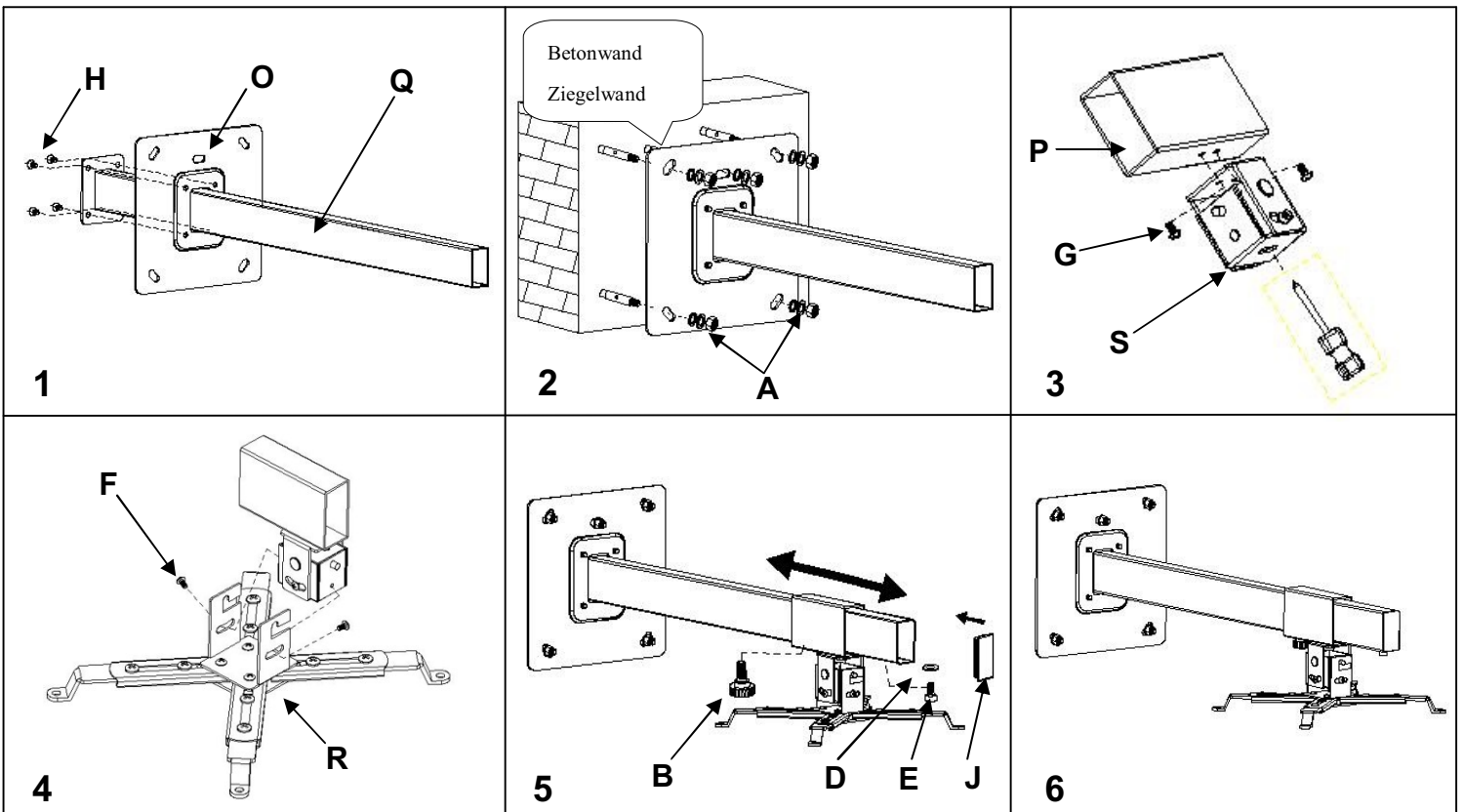



Achtung!

Diese Wandhalterung für Kurz-Distanz Projektor darf nur auf Beton- oder Ziegelwand mit den angeschlossenen Schrauben installiert werden.



Kurz-Distanz Projektor Wandhalterung (Entlastungsleine)

Teilliste

A  M5X9(X1)	B  P.W5.2X16X2.2(X2)	C  M4X3(X4)	D  X2	E  M4(X2)	F  X1	G  X1	H  M4X45(X1)	I  S=6.8
-----------------------------------------------------------------------------------------------------------	--------------------------------------------------------------------------------------------------------------------	-----------------------------------------------------------------------------------------------------------	-----------------------------------------------------------------------------------------------------	---------------------------------------------------------------------------------------------------------	------------------------------------------------------------------------------------------------------	-------------------------------------------------------------------------------------------------------	--------------------------------------------------------------------------------------------------------------	----------------------------------------------------------------------------------------------------------

Installation



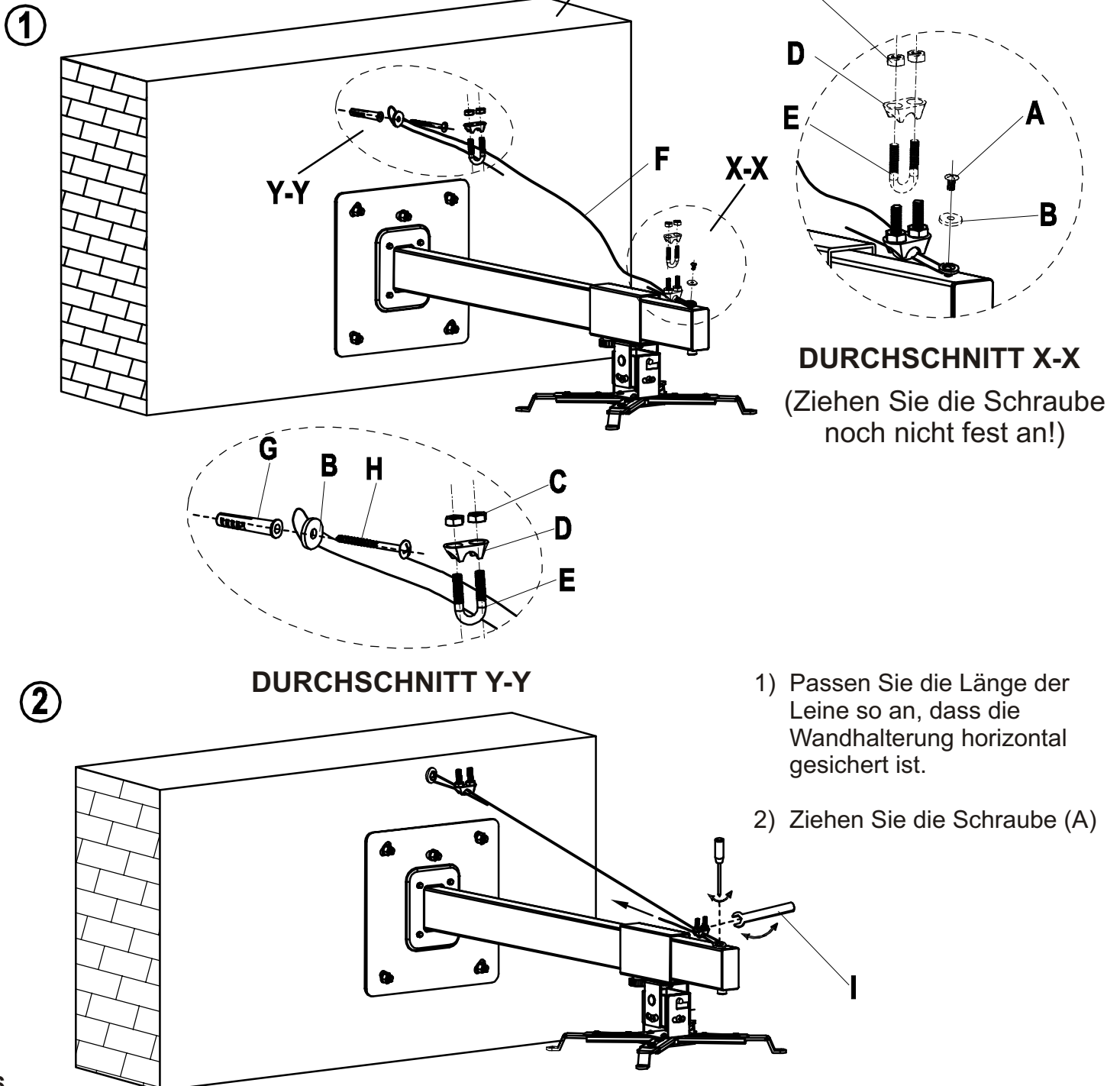







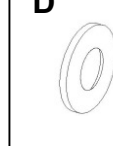
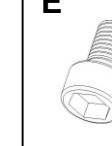

Darf nur auf Beton- oder Ziegelwand installiert werden!

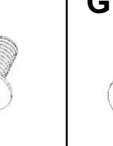
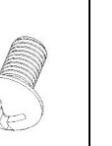
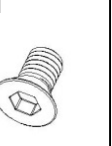

Support mural pour projecteur à focale ultra-courte

Mode d'emploi - Modèle: ST1200

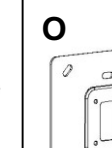
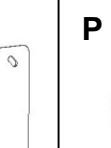
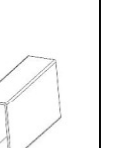
Liste des pièces

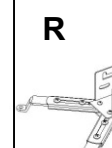
A  M8X60 (X5)	B  X1	 S=5mm (X1)	D  PW6.2X13X1(X1)	E  M6X12 (X1)	F  M4X8 (X6)	G  M5X9 (X2)	H  M5X10 (X4)	I  S=3mm (X1)	J  X1
K  X2	L  M3X8 (X4)	M  PW3.2X10X1(X4)	N  S=2.5mm (X1)	O  X1	P  X1	Q  X1	R  X1	S  X1	

Installation







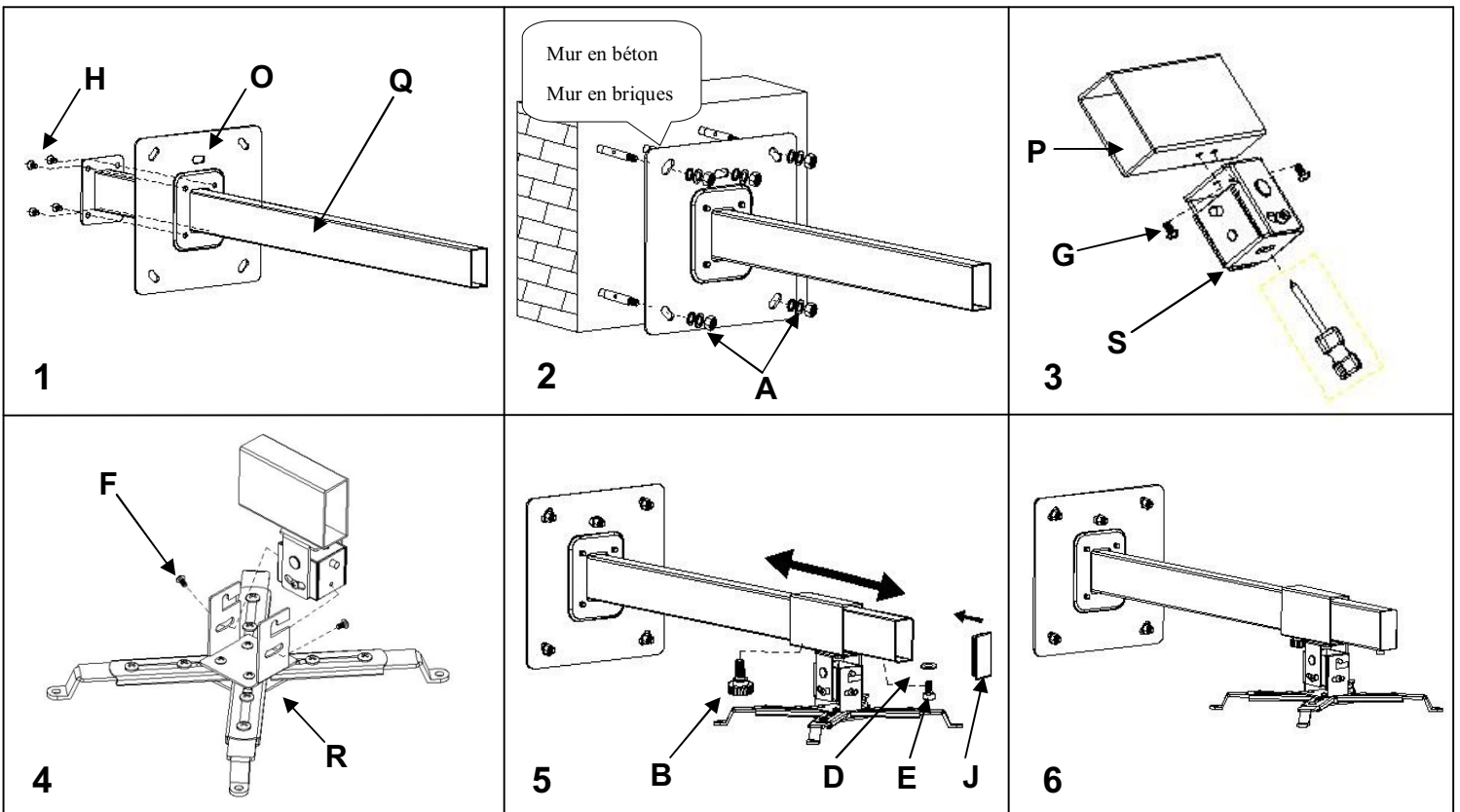



Attention!

Ce support mural du projecteur à focale ultra-courte peut être installé uniquement sur un mur en briques ou en béton à l'aide des vis fournies par le producteur.



Support mural pour projecteur à focale ultra-courte (Un fil d'ancrage)

Liste des pièces

A  M5X9(X1)	B  P.W5.2X16X2.2(X2)	C  M4X3(X4)	D  X2	E  M4(X2)	F  X1	G  X1	H  M4X45(X1)	I  S=6.8
-----------------------------------------------------------------------------------------------------------	--------------------------------------------------------------------------------------------------------------------	-----------------------------------------------------------------------------------------------------------	-----------------------------------------------------------------------------------------------------	---------------------------------------------------------------------------------------------------------	------------------------------------------------------------------------------------------------------	-------------------------------------------------------------------------------------------------------	--------------------------------------------------------------------------------------------------------------	----------------------------------------------------------------------------------------------------------

Installation

Montage uniquement sur mur en béton ou en briques!

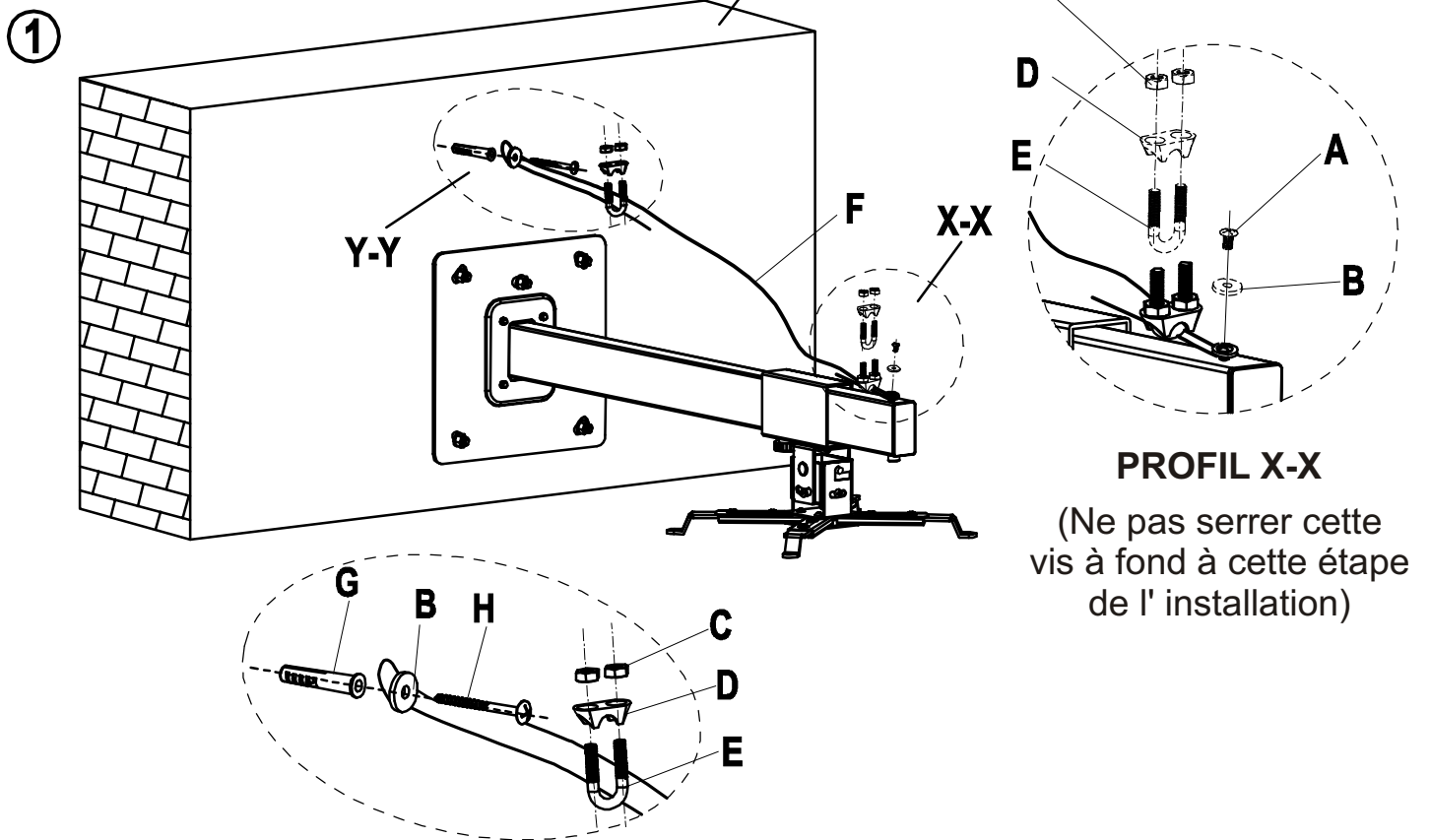

- 1) Régler convenablement la longueur du fil à cette extrémité, afin d'assurer une position horizontale de la barre du support mural.



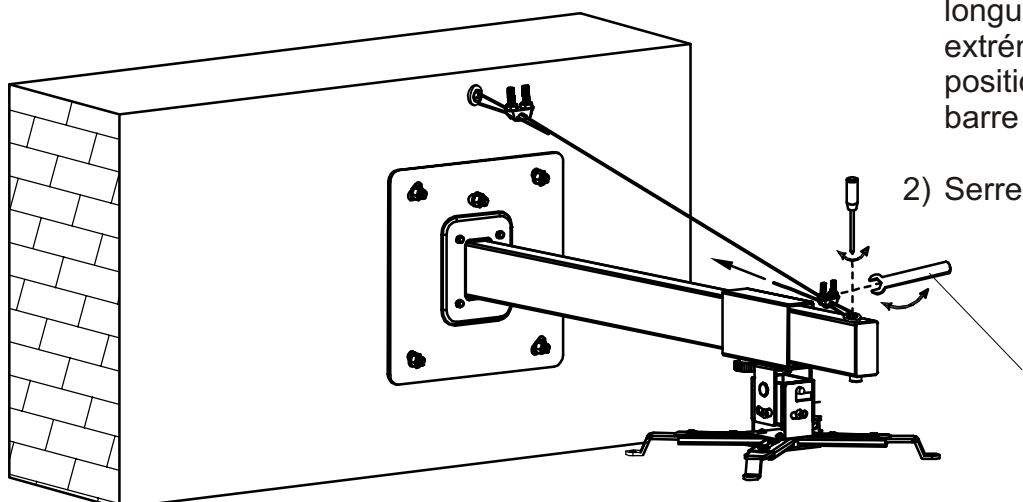







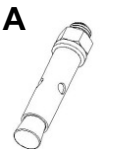

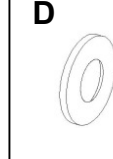
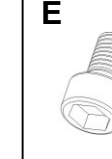
- 2) Serrer la vis (A).

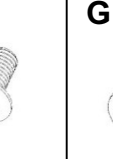
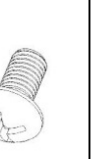
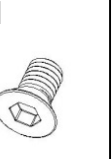

Držák širokoúhlého projektoru – návod k montáži

Model: ST1200

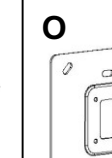
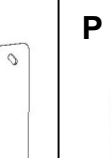
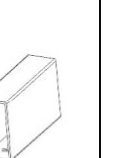
Seznam dílů

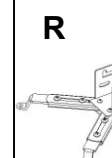
A  M8X60 (X5)	B  X1	 S=5mm (X1)	D  PW6.2X13X1(X1)	E  M6X12 (X1)	F  M4X8 (X6)	G  M5X9 (X2)	H  M5X10 (X4)	I  S=3mm (X1)	J  X1
K  X2	L  M3X8 (X4)	M  PW3.2X10X1(X4)	N  S=2.5mm (X1)	O  X1	P  X1	Q  X1	R  X1	S  X1	

Instalace







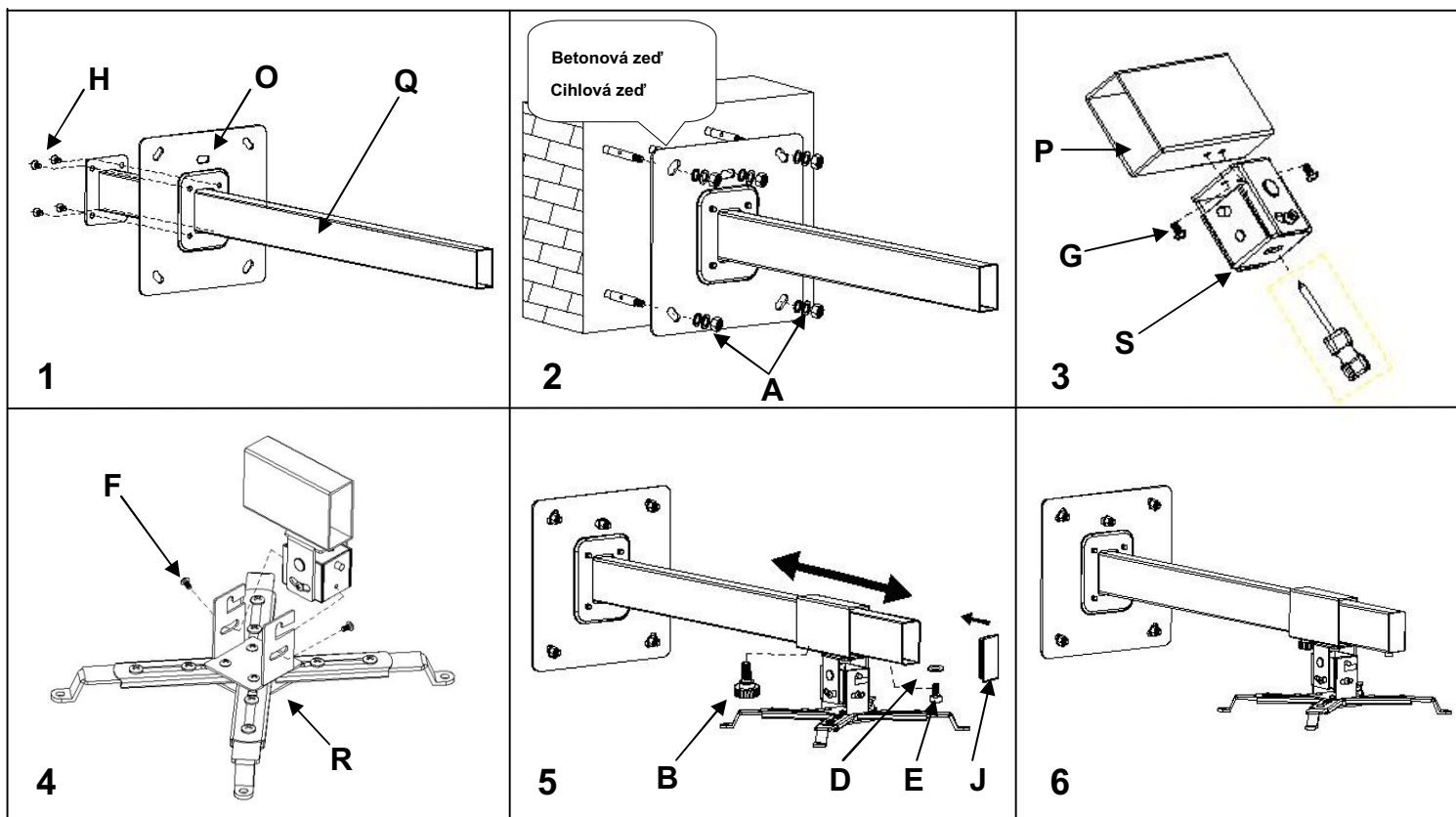



Upozornění!

Tento držák širokoúhlého projektoru se smí instalovat pouze na cihlové nebo betonové zdi a jen za použití výrobcem přiložených šroubů.



Hliníkový držák širokoúhlého projektoru s odlehčujícím lankem

Seznam dílů

A  M5X9(X1)	B  P.W5.2X16X2.2(X2)	C  M4X3(X4)	D  X2	E  M4(X2)	F  X1	G  X1	H  M4X45(X1)	I  S=6.8
-----------------------------------------------------------------------------------------------------------	--------------------------------------------------------------------------------------------------------------------	-----------------------------------------------------------------------------------------------------------	-----------------------------------------------------------------------------------------------------	---------------------------------------------------------------------------------------------------------	------------------------------------------------------------------------------------------------------	-------------------------------------------------------------------------------------------------------	--------------------------------------------------------------------------------------------------------------	----------------------------------------------------------------------------------------------------------

Instalace

Jen betonová nebo cihlová zed'

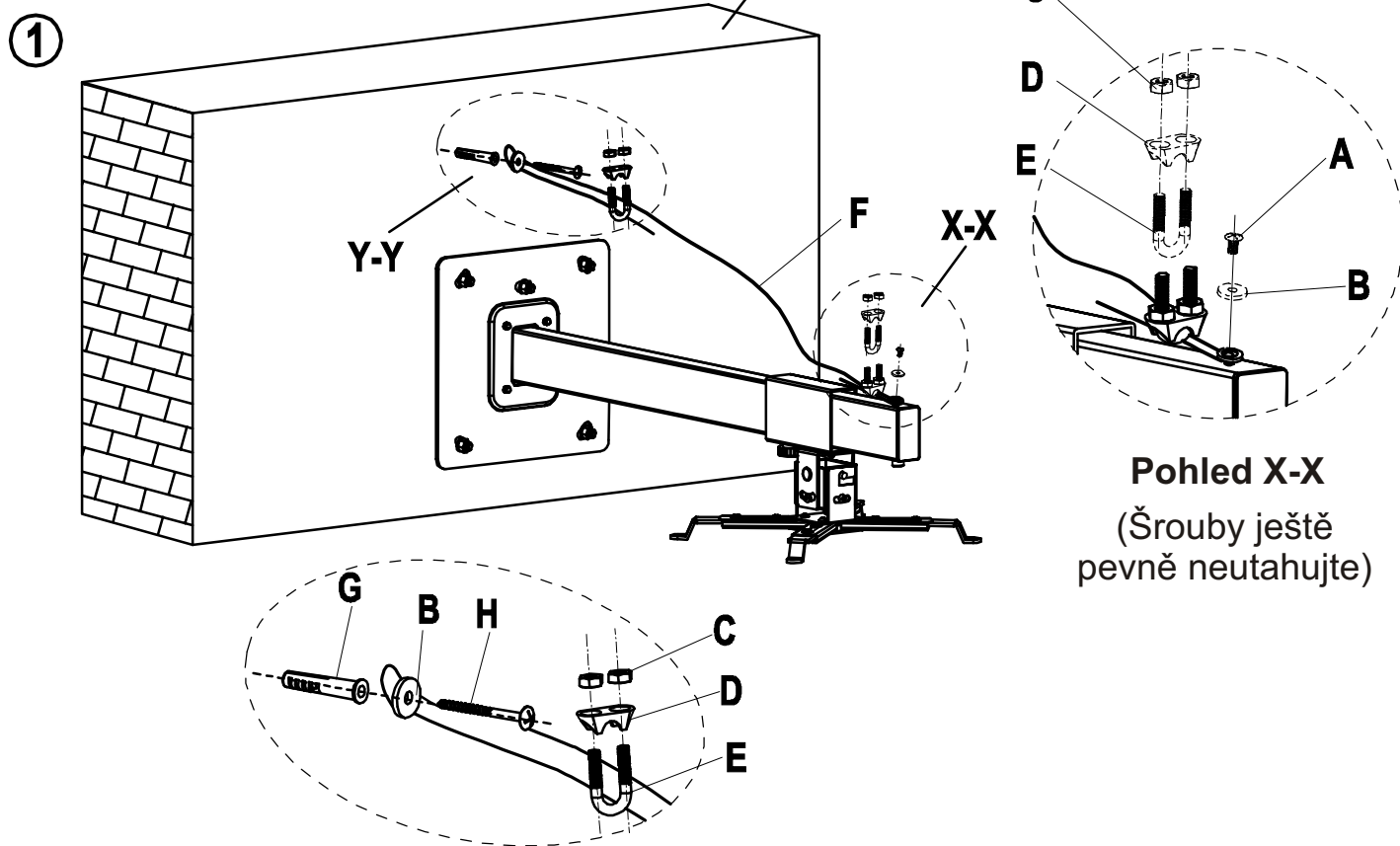

2

Pohled Y-Y

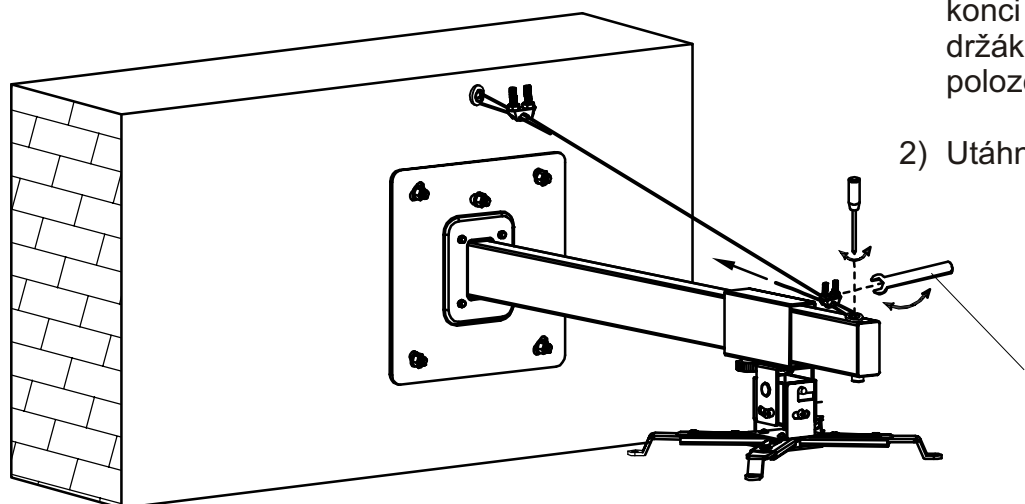







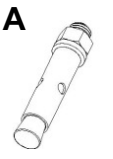
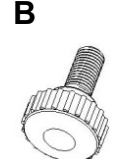

1) Nastavte lanko na tomto konci tak, aby rameno držáku bylo v horizontální poloze.

2) Utáhněte šroub (A).

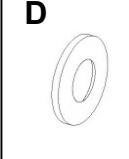
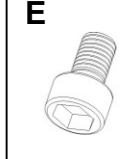
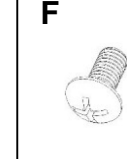
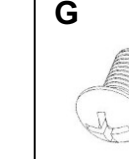
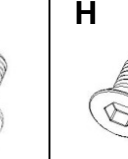
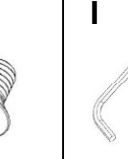
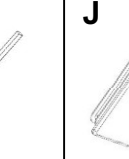
Držiak na širokouhlý projektor – návod na montáž

Model: ST1200

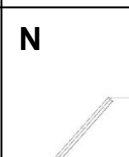
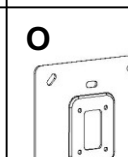
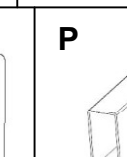
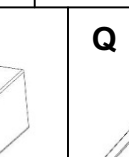
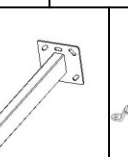
Zoznam dielov

A  M8X60 (X5)	B  X1	 S=5mm (X1)	D  PW6.2X13X1(X1)	E  M6X12 (X1)	F  M4X8 (X6)	G  M5X9 (X2)	H  M5X10 (X4)	I  S=3mm (X1)	J  X1
K  X2	L  M3X8 (X4)	M  PW3.2X10X1(X4)	N  S=2.5mm (X1)	O  X1	P  X1	Q  X1	R  X1	S  X1	

Inštalácia







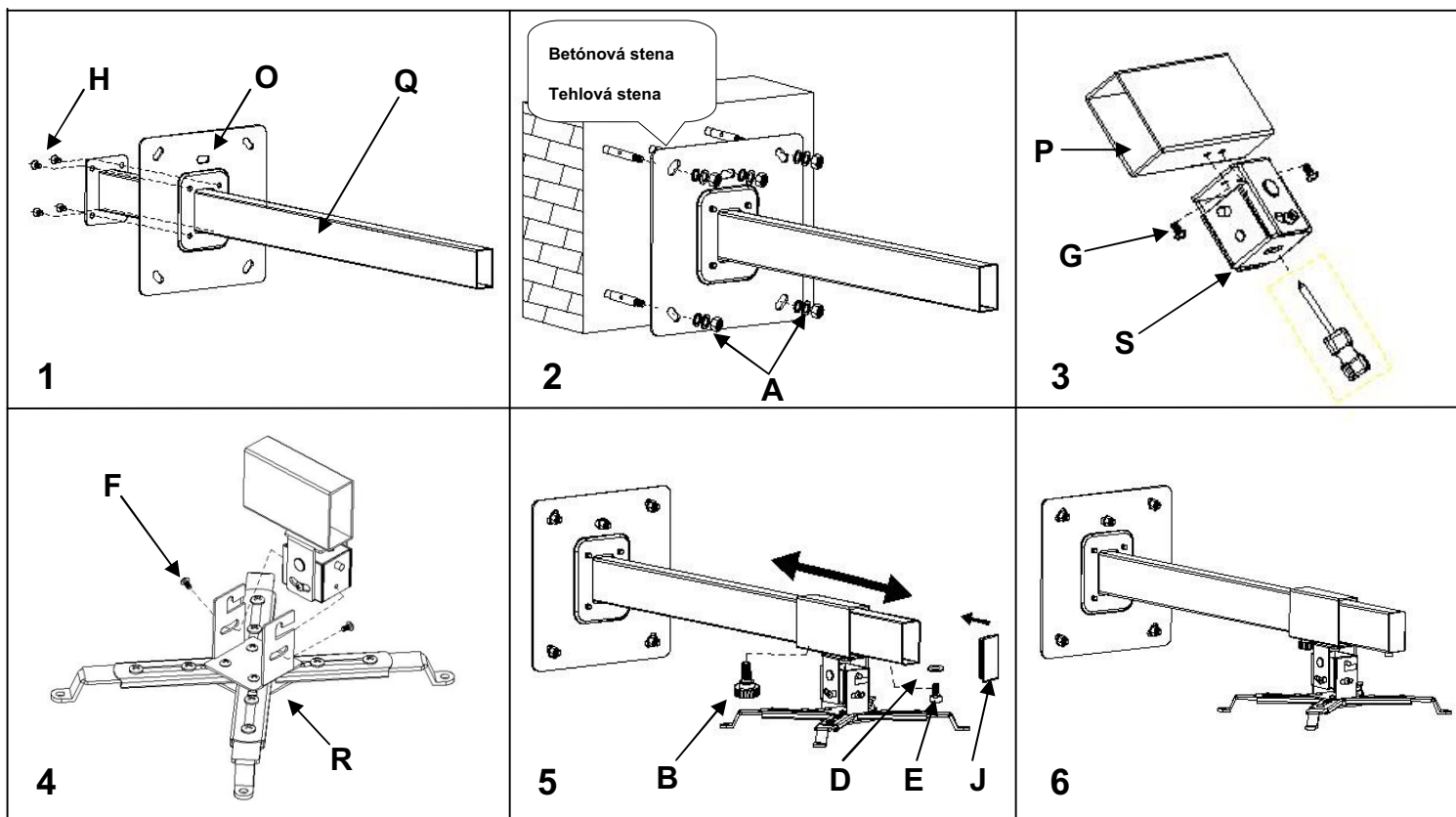



Upozornenie!

Tento držiak na širokouhlý projektor sa smie inštalovať výlučne na tehlovom alebo betónovom múre a len s použitím výrobcom priložených skrutiek.



Hliníkový držiak na širokouhľý projektor s odľahčujúcim lankom

Zoznam dielov

A  M5X9(X1)	B  P.W5.2X16X2.2(X2)	C  M4X3(X4)	D  X2	E  M4(X2)	F  X1	G  X1	H  M4X45(X1)	I  S=6.8
-----------------------------------------------------------------------------------------------------------	--------------------------------------------------------------------------------------------------------------------	-----------------------------------------------------------------------------------------------------------	-----------------------------------------------------------------------------------------------------	---------------------------------------------------------------------------------------------------------	------------------------------------------------------------------------------------------------------	-------------------------------------------------------------------------------------------------------	--------------------------------------------------------------------------------------------------------------	----------------------------------------------------------------------------------------------------------

Inštalácia

Len betónová alebo tehlová stena

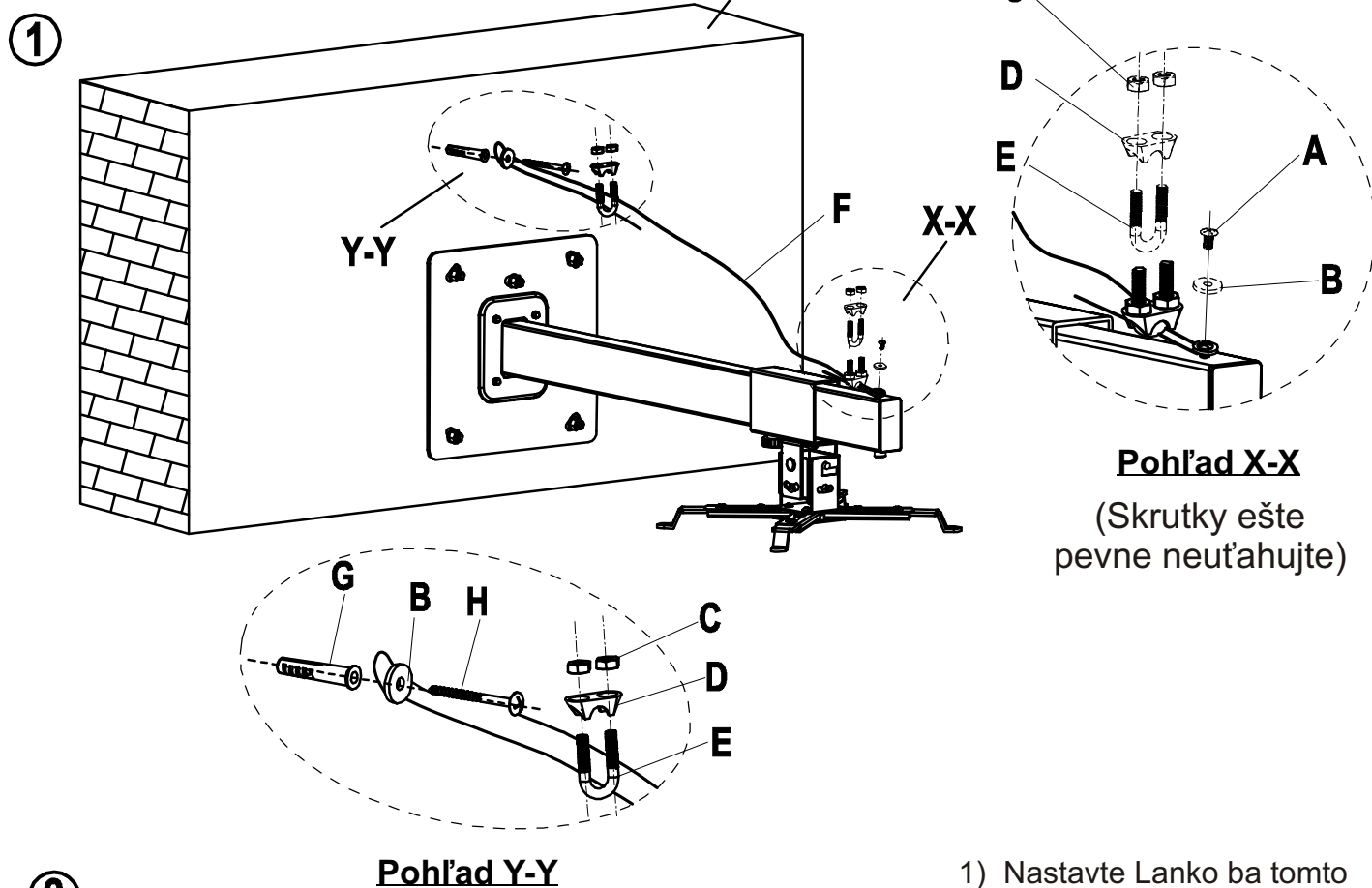

1) Nastavte Lanko ba tomto konci tak, aby rameno držiaku bolo v horizontálnej polohe.

2) Utiahnite skrutku (A).



<http://www.avtek.eu>