

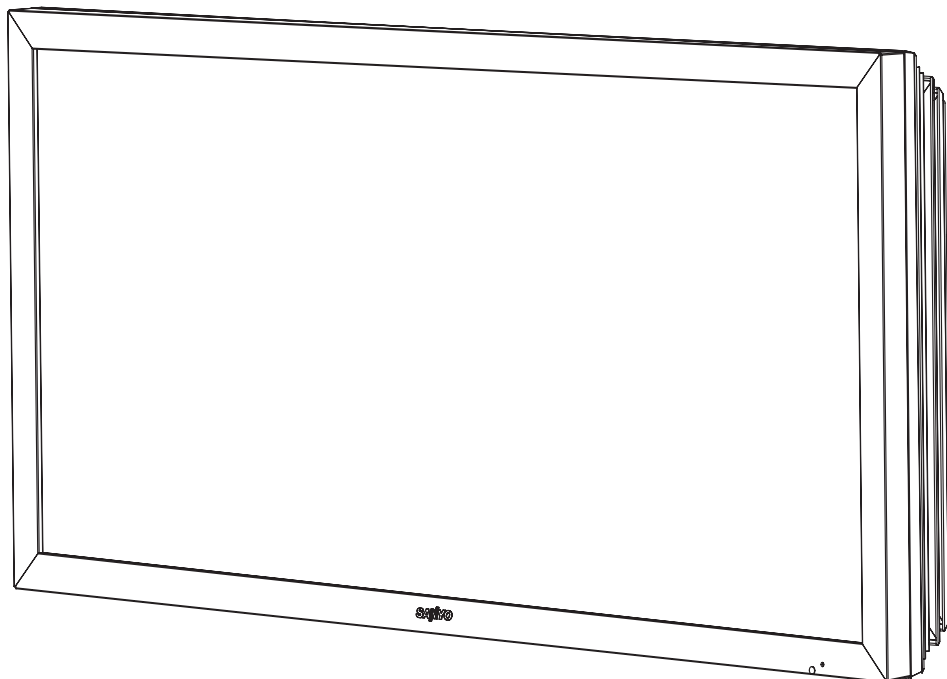

## **INSTRUCTION MANUAL**

## **LCD Monitor**

**CE42LM6R  
CE42LM6DPB  
CE42LM6WP  
CE42SR2  
CE52LH2R  
CE52LH2WP  
CE52SR2**



**Please read this Instruction book before using your LCD monitor.  
We wish you many hours of pleasure from your new LCD monitor.**

<b>TABLE OF CONTENTS</b> .....	<b>2</b>	Time menu .....	9
<b>SAFETY PRECAUTIONS</b> .....	<b>3</b>	Setup menu .....	9
Installation and Use .....	3	PC Adj. menu .....	10
<b>SERVICING</b> .....	<b>4</b>	<b>INSTALLATION MODE</b> .....	<b>11</b>
Servicing .....	4	Installation Mode .....	11
Federal Communications Commission Notice .....	4	<b>OPERATION</b> .....	<b>12</b>
AC Power Cord Requirement .....	5	Selection of picture size .....	12
End-User License .....	5	PIP/POP Operation .....	13
<b>INSTALLATION</b> .....	<b>6</b>	<b>OPERATION (IN TEXT MODE)</b> .....	<b>14</b>
Step: 1 Mains Connection .....	6	Teletext Operation .....	14
Step: 2 Connections .....	6	<b>SPECIFICATIONS/HELPFUL HINTS</b> .....	<b>15</b>
Remote control .....	7	Specification .....	15
Remote control battery installation .....	7	Helpful hints .....	15
Controls and Menus .....	8	<b>DIMENSIONS</b> .....	<b>16</b>
Menu Operation .....	8	<b>PC/DVI-D/COMPONENT SIGNAL SUPPORT</b>	
Picture menu .....	8	<b>TIMING LIST</b> .....	<b>17</b>
<b>MENU OPERATION</b> .....	<b>9</b>	<b>RS232C COMMAND TABLES</b> .....	<b>18</b>
Picture menu .....	9		
Sound menu .....	9		

### Robust monitor (CE42LM6R, CE42LM6DPB, CE52LH2R)

The robust monitor can be used in a wide variety of environments for dusty and oily circumstance such as fast food, digital signage, industrial and public display.

- **NON GLARE ACRYLIC PANEL**

This monitor set has a non glare acrylic panel. This offers the protection for the panel surface in the public display applications and easy to clean the panel.

- **ALUMINUM CABINET & NON HOLES DESIGN**

This monitor set uses Anodized aluminum and it has quite unique "Non-Holes" ventilation design which protects against mischief in the public display applications and less maintenance when used in a dusty or oily environment.

### Weather proof monitor (CE42LM6WP, CE52LH2WP)

Weather resistant and water proof in accordance with the IP66 standard.

- **ANTI REFLECTION TAMPER GLASS**

This monitor set has a tough anti reflection tampered glass. This offers the protection for the panel surface in the public display circumstance.

- **ALUMINUM CABINET & NON HOLES DESIGN**

This monitor set uses Anodized aluminum and it has quite unique "Non-Holes" ventilation design which protect against mischief in the public display applications and less maintenance from dust and oil circumstance, and having perfect protection of IP66 weather-resistant approval.

### Daylight readable monitor (CE42SR2, CE52SR2)

In addition to Weather proof monitor, it has adaptive brightness in accordance with prevailing light conditions.

- **EXTENSIVE INPUT & OUTPUT TERMINALS (for all products)**

This monitor set has various input and output terminals including component (Y,Pb,Pr) or RGBHV input and output with 5-BNC, composite video input and output with BNC, and RS-232 control port (serial D-Sub 9) input and output which offer the daisy chain connection. There are computer inputs (a D-Sub 15 RGB terminal) and DVI-D input with HDCP for High definition signals. There are also jacks for external speakers.

### Trademarks

Each name of corporations or products in this book is either a registered trademark or a trademark of its respective corporation.

**CAUTION: Please read and retain for your safety.** This unit has been designed and manufactured to assure your personal safety, but improper use can result in potential electric shock or fire hazards. In order not to defeat the safeguards incorporated in this monitor observe the following basic rules for its installation, use and servicing.

### Installation and Use

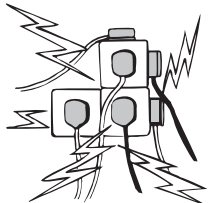

**Do not** allow anything to rest on the power cord. **Do not** locate this LCD monitor where the cord will be damaged by people walking on it.

**Do not** overload wall outlets and extension cords as this can result in fire or electric shock. A suitable socket outlet must be provided near to the monitor and shall be easily accessible.

**Do not** place this LCD monitor near any heat sources such as radiators, heaters, stoves and other heat-generating products (including amplifiers).

**Do not** place your LCD monitor on an unstable stand, shelf or table. Serious injury to an individual, and damage to the LCD monitor may result if it should fall. Your sales person can recommend an approved wall mounting kit. A special wall mounting kit is available for this model.

This LCD monitor should be operated only from the type of power source indicated on the monitor or as indicated in the Operating Instructions. If you are not sure of the type of power supply, consult your sales person or your local power company.

**For added protection** it is strongly recommended that this LCD monitor has its mains supplied via an approved earth fault protection device.

**WARNING:** To prevent injury the LCD monitor must be securely attached to the wall in accordance with the manufacturers installation instructions.

#### IMPORTANT:

**This product must be earthed.**

This unit is not disconnected from the mains unless the mains lead is unplugged. The installer must make sure that the waterproof inline coupler is easily accessible.

*(CE42LM6WP/CE42SR2/CE52LH2WP/CE52SR2 model only)*

This monitor is tested to **IP66** standard rating.

This monitor is **not** protected against temporary or continuous immersion in liquid.

**Do not** use immediately after moving the LCD monitor from a low temperature to a high temperature environment, as this causes condensation, which may result in fire, electric shock, or other hazards. Before cleaning, unplug the monitor from the wall socket.

**Do not** mount near an open flame source. Open flames must never be used near this LCD monitor.

**This LCD monitor** should not be built in or enclosed in any way, heat build up will reduce the life of the monitor.

This LCD monitor should have a minimum distance of 5cm away from the wall and the monitor should have 10cm distance around the top and sides.

**Always** mount using recommended and substantial fixtures and fittings.

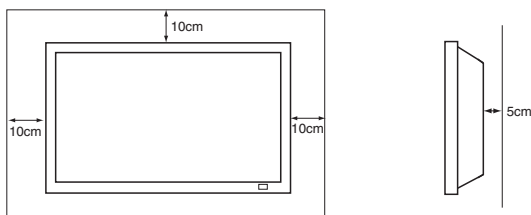

The rear finned section around the cabinet functions as a heat sink, removing heat away from the monitor. The external surface of the cabinet (finned area) must not be covered or the airflow restricted in anyway by enclosing the LCD monitor.

*(CE42LM6WP/CE42SR2/CE52LH2WP/CE52SR2 model only)*

The operating temperature range of this monitor is guaranteed 0°C ~ 40°C/32°F ~ 104°F. It is not recommended to install the screen in direct sunlight without adequate shading, as this will cause the temperature of the panel to rise above the maximum specified. Doing so may cause a black shadow to appear on the screen which will disappear when the screen temperature returns to within the specification. This "of course" does not produce any harmful effect on the lifetime of the monitor.

**Do not** apply liquid cleaners or aerosol cleaners directly onto the LCD monitor. Use a damp cloth for cleaning.

#### ADDITIONAL FOR NORTH AMERICA AND CANADA:

This monitor must **NOT** be permanently mounted to the building structure. It must be mounted in such a way that it can be removed using basic tools.

The power supply cord must **NOT** be attached to the building surface. The power supply cord must **NOT** be routed through walls, ceiling, floors, or other similar openings in the building structure.

The power supply cord **MUST** be positioned so as to prevent physical damage.

#### Important: (UK only)

##### THIS PRODUCT MUST BE EARTHED.

This equipment is fitted with an approved mains lead and an approved non rewirable UK mains plug. To change a fuse in this type of plug proceed as follows:

1. Remove the fuse cover and fuse.
2. Fit a new fuse which should be a BS1362 13 Amp A.S.T.A. or BSI approved type.
3. Ensure that the fuse cover is correctly refitted.

If the fuse cover is lost or damaged the plug must **NOT** be used but replaced with a serviceable plug.

If the fitted plug is not suitable for your socket outlets, it should be cut off and an appropriate plug fitted in its place. If the mains plug contains a fuse, this should have a rating of 13 Amp, ensure the fuse cover is correctly fitted. If a plug without a fuse is used, the fuse at the distribution board should not be greater than 13 Amp.

**Note:** The severed plug must be destroyed to avoid a possible shock hazard should it be inserted into a 13 Amp socket elsewhere.

The wires in this mains lead are coloured in accordance with the following code:

Blue → Neutral  
Brown → Live  
Green and Yellow → Earth

1. The Blue wire must be connected to the terminal which is marked with the letter "N" or coloured BLACK.
2. The Brown wire must be connected to the terminal with the letter "L" or coloured RED.
3. The Green and Yellow wire must be connected to the terminal which is marked with the letter "E" or coloured GREEN or GREEN and YELLOW.

Before replacing the plug cover, make certain that the cord grip is clamped over the sheath of the lead - not simply over the wires.

**Do not** attempt to bypass the safety purpose of the grounding type plug.

**THIS UNIT IS NOT DISCONNECTED FROM THE MAINS UNLESS THE MAINS LEAD IS UNPLUGGED.**

**THE INSTALLER MUST MAKE SURE THE MAINS LEAD IS EASILY ACCESSIBLE.**

### Servicing

Your monitor is fully transistorised and does not contain any user serviceable components.

You must not remove the rear cover of the monitor by yourself. The apparatus is working with high voltages and could damage objects or even endanger people. Leave all required repair and service jobs to an authorised service technician. He will exclusively use such spare parts that are complying with the same safety standards as applicable to the original parts. The use of original spare parts can prevent fire, shock and other hazards.

Unplug the LCD monitor from the wall outlet and refer servicing to qualified service personnel under the following conditions:

- If the power cord or plug is damaged.
- If liquid has been spilt in to the LCD monitor.
- If the LCD monitor has been dropped or the cabinet has been damaged.
- If the LCD monitor exhibits a distinct change in performance.
- If the LCD monitor does not operate normally by following the operating instructions.
- If the LCD monitor has been exposed to rain or water. (CE42LM6R/CE42LM6DPB/CE52LH2R model only)



Adjust only those controls that are covered in the operating instructions as improper adjustment of other controls may result in damage. This will often require extensive work by a qualified technician to restore the monitor to normal operation.

### Important recycling information.

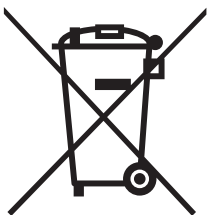

Your SANYO product is designed and manufactured with high quality materials and components which can be recycled and reused.

This symbol means that electrical and electronic equipment, at their end-of-life, should be disposed of separately.

In the European Union there are separate collection systems for used electrical and electronic products.

**Please help us to conserve the environment we live in!**

**Note:** This symbol mark and recycle system are applied only to EU countries are not applied to other countries of the world.

### Federal Communications Commission Notice

This equipment has been tested and found to comply with the limits for a Class A digital device, pursuant to Part 15 of FCC Rules. These limits are designed to provide reasonable protection against harmful interference when the equipment is operated in a commercial environment. This equipment generates, uses, and can radiate radio frequency energy and, if not installed and used in accordance with the instruction manual, may cause harmful interference to radio communications. Operation of this equipment in a residential area is likely to cause harmful interference in which case the user will be required to correct the interference at his own expense.

Do not make any changes or modifications to the equipment unless otherwise specified in the instructions. If such changes or modifications should be made, you could be required to stop operation of the equipment.

### Canadian Radio Interference Regulations

This Class A digital apparatus meets all requirements of the Canadian ICES-003.

### WARNING

This is a Class A product. In a domestic environment this product may cause radio interference in which case the user may be required to take adequate measures.

## AC Power Cord Requirement

The AC Power Cord supplied with this LCD monitor meets the requirement for use in the country in which you purchase it.

### AC Power Cord for the United States and Canada:

AC Power Cord used in the United States and Canada is listed by the Underwriters Laboratories (UL) and certified by the Canadian Standard Association (CSA).

AC Power Cord has a grounding-type AC line plug. This is a safety feature to make sure that the plug will fit into the power outlet. Do not try to defeat this safety feature. Should you be unable to insert the plug into the outlet, contact your electrician.

**THE SOCKET-OUTLET SHOULD BE INSTALLED NEAR THE EQUIPMENT AND EASILY ACCESSIBLE**

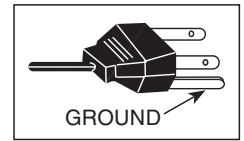

## End-User License

The product (meaning the equipment or appliance to which this documentation relates) incorporates Software (the software applications, utilities and modules embedded within the Product) which is owned by Sanyo or its licensors. Before using the product, please read the End-User License Conditions detailed below. If you do not agree to the terms and conditions of the End-User License, Please do not proceed to use the Product- repack the Product unused and return it to your supplier together with proof of purchase for a full refund. By using the product, you agree to be bound by the terms and conditions of the End-User License.

### License Grant, Conditions and restrictions

1. Sanyo grants you a non-exclusive, world-wide (subject to export controls), non-transferable (except as permitted by 2 below), royalty-free license to use the Software upon and with the Product.
2. You may not transfer any of your license rights in the Software without the prior written consent of SANYO and if consent is provided then the Software shall only be transferred in conjunction with the transfer of the Product AND provided that the transferee has read and agreed to accept the terms and conditions of this license.
3. You must ensure that the copyright, trademark and other protective notices contained in the Software are maintained and not altered or removed.
4. The Software provided hereunder is copyrighted and licensed (not sold). SANYO especially does not transfer title or and ownership rights in the Software to you. The Software provided hereunder may contain or be derived from portions of materials provided to SANYO under license by a third party supplier.
5. Except as expressly permitted by statute you may not;
  - use the Software in conjunction with any other computer hardware other than the product;
  - copy all or part of the Software;
  - incorporate all (or any of) the Software into other programs developed by (or on behalf of) you and/or used by you;
  - reverse-engineer, decompile or disassemble the Software;
  - make the Software (or any part of it) available, or permit its redistribution, for use with any computer hardware other than the Product; or rent, lease, gift, loan, sell, distribute or transfer possession of the whole or any part of the Software.

### Termination

This license is effective until terminated. This license will terminate automatically without notice if you fail to comply with any of its provisions.

### Disclaimer

1. The Software is (to the extent permitted by law) supplied "as is" and SANYO and its suppliers expressly exclude all warranties, express or implied, including (but not limited to) warranties of satisfactory quality, fitness for purpose and non-infringement (save to the extent that the same are not capable of exclusion at law).
2. In no circumstances will SANYO be liable for any direct, indirect, consequential, or incidental damage (including loss of profits, business interruption, loss of data or the cost of procurement of substitute goods, technology or services) arising out of the use or the inability to use the Software (save to the extent that such liability is not capable of exclusion at law).

### General

1. This End-User License will be governed by laws of England and the User may only bring claims in the English Courts and SANYO shall be entitled to bring a claim in the courts of any jurisdiction.
2. This End-User License is governed by the laws of the State of California. The End-User and Sanyo agree that any action to enforce or interpret the terms of this End-User License shall be brought only in the appropriate state or federal court located in Los Angeles County, California. The End-User and Sanyo hereby submit to the exclusive jurisdiction and venue of such court.
3. The above terms and conditions supersede any prior agreement, oral or written, between you and SANYO relating to the Software.

## Step: 1 Mains Connection

- Connect the display unit to VGA, BNC and Scart connector as required.

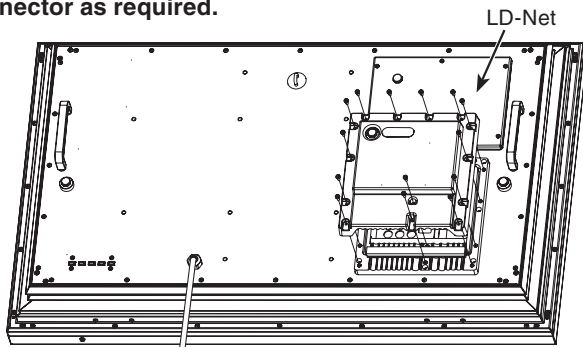

\* This figure is 42 inch model.

1. Connect the in-line power connector to the Mains Inlet as shown above.
2. Connect the power cord of the LCD monitor to a suitable wall outlet.
  - As this product does not have a mains On/Off switch, please ensure your mains plug is easily accessible.
  - The LCD monitor is prepared for a mains voltage AC100 ~ 240V, 50Hz/60Hz. To completely switch off the mains, or when the display unit is not to be used for an extended period of time, it is advisable to disconnect the power cord from the power outlet.

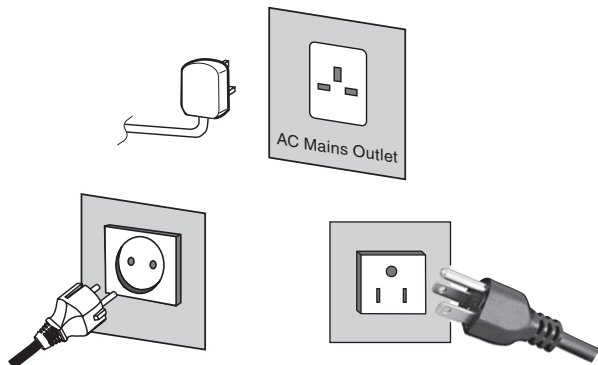

- Please use the correct mains lead supplied with the set for your area.

- 3. Warning:** To prevent injury, the unit must be securely attached to the wall in accordance with the installation instructions.



**WARNING!** High voltages are used in the operation of this set. Refer service to qualified service personnel.

## Step: 2 Connections

### ■ INPUT selection

To switch either AV1, RGB, AV2, AV3, PC, DVI or Network by pressing the **INPUT** button on your remote control repeatedly.

1. **AV1**  
SCART connection/CVBS/RGB/S-VIDEO.
2. **RGB**  
TTL input (5V RGB signals) into SCART terminal.

### 3. Y, Pb, Pr/RGBHV connection (AV2)

Choose Y, Pb, Pr or RGB H/V connection by selecting AV2 Setting in Set up menu (see page 10). You can connect your DVD player to the Y, Pb, Pr terminals instead of using a scart lead. This can support high definition in analogue component form. RGB H/V can be used as a PC input via the BNC terminals. Both options support a large range of resolutions (page 17). AV2-OUT can be used to output the incoming AV2 signal to the other monitor.

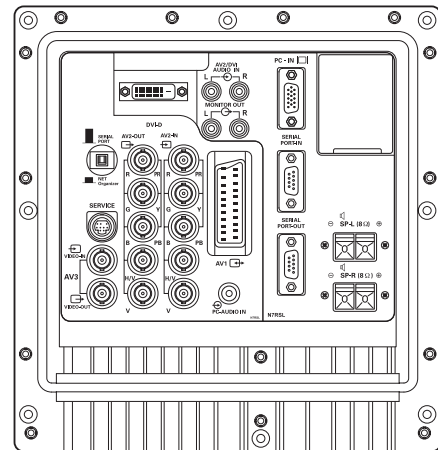

### 4. AV3

Composite (CVBS) signal input.

AV3-OUT can be used to output the incoming AV3 signal to the other monitor.

### 5. DVI-D (Digital Video Interface)

DVI-D supports a large range of resolutions as shown on page 17.

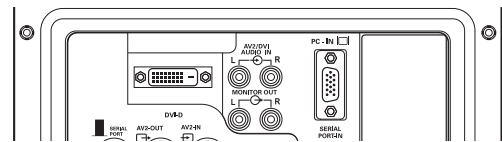

### 6. PC connection

PC input (PC-IN D-SUB). This input supports a large range of resolutions as shown page 17. Audio can be connected via the 3.5mm PC-AUDIO IN.

### 7. External Speaker

Output the audio signal from AV1, AV2, AV3, PC and DVI. The speaker impedance is 8 ohms.

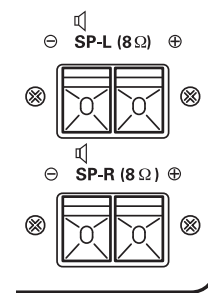

### 8. AV2 / DVI AUDIO IN

Connect the audio output (stereo) from a computer or video equipment connected AV2 or DVI.

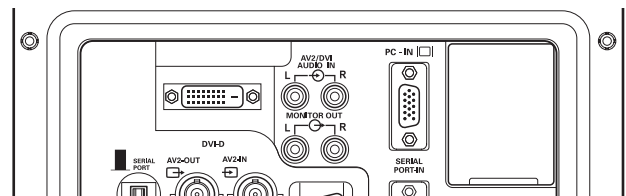

### 9. Monitor Audio OUT

This terminals output fixed level from AUDIO IN.

### 10. RS232C IN/OUT

When the monitor is controlled by a computer, connect to this jack with serial control cable.

You can connect to another monitor with RS232C OUT.

When you connect PC with RS232C, select "ON" at Network standby in Installation mode.

If it is selected "OFF", RS232C terminals do not functional. Also select push button to "SERIAL PORT".

## Remote control

**Input**

To switch input source from **AV1, RGB, AV2, AV3, PC, DVI** or **Network** mode.

**Wide**

To select the screen mode **Full, Full All, Zoom 16:9, Title in 16:9, Zoom 14:9, Title in 14:9, Normal** or **Natural wide**. Refer to page 12.

**Menu**

To enter and exit the main menu, and sub menu.

**Level Up/Down**

To adjust the sound volume level or enter sub menus.

**F/OK**

To confirm the initial setting in the menu.

**Picture mode selector**

Press the **→←** button repeatedly to select the following picture mode.

**Personal** - Personal preference mode.

**Standard** - Normal viewing mode.

**Dynamic** - Suitable for brightly lit rooms.

**Soft** - Low contrast setting

**Eco** - Suitable for dimly lit rooms and gives a cinema-like effect.

**Freeze**

To switch picture still on or off.

**Green**

Press this button for more than 5 seconds, installation mode will appear.

**Standby**

To switch the monitor on and off. Also see page 8.

**Recall**

To display input selection information and the Time set.

You can also select colour systems in AV1/AV3 mode as follows: **AUTO → PAL → SECAM → NTSC → NTSC4.43 → PAL M → PAL N.**

**Auto PC**

It can also be automatically adjusted in PC mode by pressing this button for twice.

**Back**

Used to return to the previous menu.

**Up and Down**

To select the next or previous item.

**Sound Mute**

To mute the sound from the speakers.

The sound changes as follows: **Normal volume ↔ Mute.**

**Bass Expander**

To get an emphasised bass sound ON or OFF.

**TXT/TV**

To select Teletext mode.

**Main/Sub Picture Swap**

To swap Main and Sub picture.

**ON/OFF**

To switch **OFF → PIP(1) → PIP(2) → POP** mode in turn.

Refer to page 13.

## Remote control battery installation

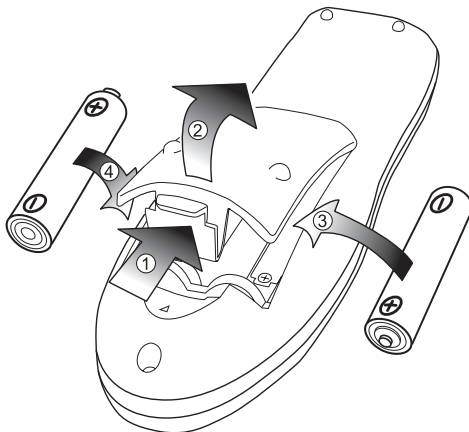

Install two "AA" 1.5 volt batteries so that the "+" and "-" marks on the batteries match the "+" and "-" marks inside the unit into the remote control handset.

## FOR EU USERS

The symbol mark and recycling systems described below apply to EU countries and do not apply to countries in other areas of the world. Your SANYO product is designed and manufactured with high quality materials and components which can be recycled and/or reused.

The symbol mark means that electrical and electronic equipment, batteries and accumulators, at their end-of-life, should be disposed of separately from your household waste.

**Note:**

If a chemical symbol is printed beneath the symbol mark, this chemical symbol means that the battery or accumulator contains a heavy metal at a certain concentration. This will be indicated as follows: Hg: mercury, Cd: cadmium, Pb: lead

In the European Union there are separate collection systems for used electrical and electronic equipment, batteries and accumulators. Please, dispose of them correctly at your local community waste collection/recycling centre.

Please, help us to conserve the environment we live in!



### Controls and Menu

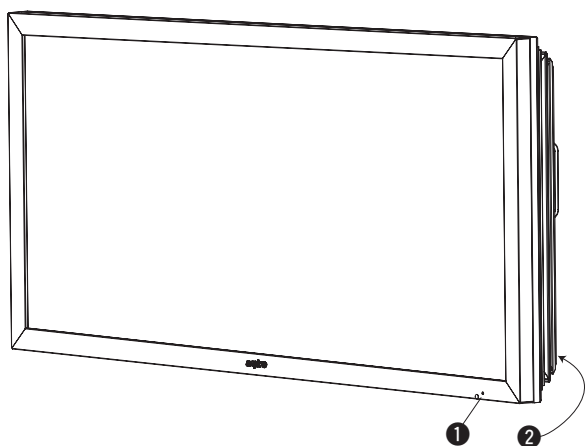

1 The LCD display has a Standby light to show there is power.

#### Switching into/from standby mode

The Standby mode is used for switching the LCD monitor off for short periods of time. In standby mode the monitor is switched off but is still receiving mains power.

- To turn the monitor into standby mode, press the **⏻ button**. The blue power indicator illuminates more brightly.
- To turn the monitor ON from standby mode, press the **⏻ button** again.

	If you find the power indicator flashing, disconnect power cord from the power outlet and contact our Service desk.
	This warning is a sign to let you know that the power protection function of this TV set is now operating.

#### 2 Control buttons (bottom corner of back cover)



**Menu button:** Used to display or cancel main menu.

**Input/v button:** Switch between AV1, RGB, AV2, AV3, PC, DVI or Network mode. It is also used to provide sub menu selection from the Main Menu.

**Left/Right arrow buttons:** provide up and down adjustments.

**Power button:** To switch to standby mode (to switch off completely disconnect the monitor from the power supply).

### Menu Operation

Many of your monitors functions are controlled through the menu function, using the remote control.

- MENU
  - Picture—Brightness
  - Contrast
  - Color
  - Tint (only if NTSC equipment is detected)
  - Sharpness
  - White Tone — White Tone / R / G / B
  - Advanced Setting — DCDi / ACC/ACM / CCS / DNR / MPEG NR / Film Mode
  - Sound—Treble
  - Bass
  - Balance
  - Bass Expander — On / Off
  - Time — Current Weekday
  - Current Time
  - Schedule — 1 - 20
  - Weekday
  - Time
  - Action — Power On / Power Off
  - On Program — AV1 / RGB / AV2 / AV3 / PC / DVI / Network
  - Active — On / Off
  - Setup — Menu Setup — Language / H/V-Position / Duration / Transparency
  - PIP / POP Setup — PIP/POP Mode / Main/Sub Source / PIP Position
  - Initial Settings
  - Text Language — Western / Eastern / Russian / Arabic / Farsi
  - Tile Mode — Tile Mode Active / H/V\_Sets / H/V Location / Bezel H/V Adjustment
  - AV2 Setting — RGBHV / YPbPr
  - Native Resolution — XGA / WXGA 1366x768
  - PC Power save — On / Off
  - PC Adj.—Auto Adjust
  - H-Position
  - V-Position
  - Clock
  - Phase

During menu operation the bottom of the on screen display will show which controls can be used for menu navigation.

Press the **MENU button** to enter the main menu. Whenever main menu is accessed initially, **PICTURE** will be the default selection.

A sub menu is selected using the **P▲** or **P▼** button and pressing the **▲+** or **▲-** button when the required sub menu is highlighted. When you have finished you can press the **BACK button** to return to the previous menu, press the **MENU button** to exit the menu operation.

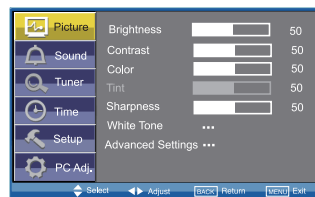

### Picture menu

1. Press the **MENU button**. **PICTURE** will be the default selection. Press the **▲+** or **▲-** button to enter.

Set the picture settings for your **“personal”** preference.

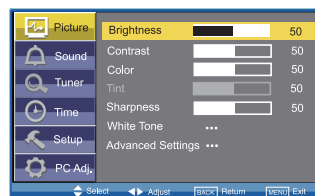

2. Use the **P▲** or **P▼** button to select eg. Brightness and the **▲+** or **▲-** button to adjust levels.

#### White Tone

May be used to adjust the color tone of the picture. Use the **P▲** or **P▼** button to select **White Tone** and press the **▲+** or **▲-** button to enter the sub menu. You can select **Personal, Cool, Standard** or **Warm** settings by using the **▲+** or **▲-** button. To adjust the color tone of the picture by using the **P▲** or **P▼** button to select **Red(R)**, **Green(G)** or **Blue(B)** and the **▲+** or **▲-** button to adjust levels. These settings will be stored in personal mode automatically.

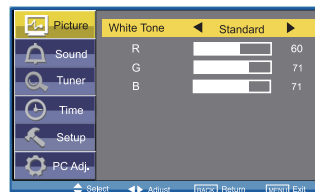



## Picture menu

### Advanced settings

Use the **P▲** or **P▼** button to select **Advanced settings** and press the **▲+** or **▲-** button to enter the sub menu as follows.

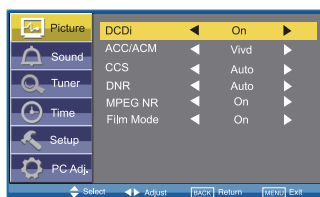

**DCDi** (Directional Correlational Deinterlacing) is used to process moving angled edge in deinterlacing to get the smoothest and most natural image. Press the **▲+** or **▲-** button on the remote control to select **On** or **Off**.

**ACC/ACM** (ACC: Adaptive Contrast and Color; ACM-II: Active Color Management-II) is used to select adaptive Brightness, Contrast and tone control. Press the **▲+** or **▲-** button on the remote control to select suitable mode either **Vivid**, **Cinema**, **Sport** or **Off**.

**CCS** (Cross Color Separation) is used to remove residual chroma information from luminance signal which is the result of imperfect decoding of composite video. Press the **▲+** or **▲-** button on the remote control to select either **Auto**, **Standard** or **Off**.

**DNR** (Digital Noise Reduction) is available for noise reduction. Press the **▲+** or **▲-** button on the remote control to select either **Auto**, **Low**, **Mid**, **High** or **Off**.

**MPEG NR** (MPEG Noise Reduction): Removes unwanted ringing and block noise from images that have undergone MPEG or JPEG compression and decompression. Press the **▲+** or **▲-** button on the remote control to select **On** or **Off**.

**Film Mode** (Inverse 3:2 pulldown): Film vs.Video-Detect film. Performed on material which underwent technologic conversion to video. Press the **▲+** or **▲-** button on the remote control to select **On** or **Off**.

## Sound menu

Press the **MENU** button and select **Sound** using the **P▲** or **P▼** buttons, press the **▲+** or **▲-** button to enter.

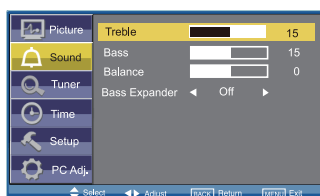

Select and adjust to obtain the best sound settings for your environment using the **P▲** or **P▼** button to select **Treble**, **Bass** or **Balance** and the **▲+** or **▲-** button to adjust levels.

**Bass Expander** can also be selected using the **P▲** or **P▼** button and pressing the **▲+** or **▲-** button to select **On** or **Off**.

These settings automatically store when you exit the menu.

Press the **BACK** button to return to the previous menu.

Press the **MENU** button to exit menu operation.

## Time menu

Press the **MENU** button and select **Time** using the **P▲** or **P▼** buttons, press the **▲+** or **▲-** button to enter. Press the **BACK** button to return to the previous menu. Press the **MENU** button to exit menu operation.

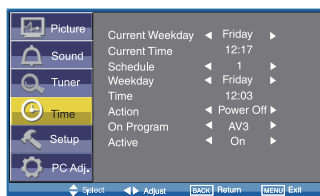

### Current Weekday

Use to set current weekday using the **▲+** or **▲-** button.

### Current Time

Use to set the current time using the Numeric buttons.

Other items in Time Menu should not be selected until Current Time has been set.

### Schedule

Use to set up to 20 separate time schedules for "Power On" or "Power Off", select 1 ~ 20 using the **▲+** or **▲-** button.

### Weekday

Use to set the schedule for "Power On" or "Power Off" of any weekday from Sunday through to Saturday or Everyday using the **▲+** or **▲-** button.

### Time

Use to set the schedule for "Power On" or "Power Off" of any time using the Numeric buttons.

### Action

Use to set the schedule for "Power On" or "Power Off" active using the **▲+** or **▲-** button.

You can set Power On timer in Time menu selecting "ON" in "On Timer Function" in Installation Mode. If it is selected "OFF", Power On display in Time menu does not functional.

### On Program

Use to select **AV1**, **RGB**, **AV2**, **AV3**, **PC**, **DVI** or **Network** for the schedule of "Power On" using the **▲+** or **▲-** button.

### Active

Use to select ON or OFF using the **▲+** or **▲-** button. When set "OFF" the above items "Schedule", "Weekday", "Time", "Action" or "ON Program" will be inactive.

Use **NUMERIC buttons [0 ~ 9]** to set **On Time**. (Action "Power On" – 00:00 ~ 23:59)

Once On Time has been set, when the set time is reached, the monitor will leave the stand-by status and enter to the source automatically.

After On Time has been set, you can go on watching other programs. When the set time is reached, the monitor will automatically switch to the preset program.

On Program can only be selected when Action (Power On) has been set.

Action (Power Off) can be set to turn the monitor into standby at a selected time

Once On Program has been set, when the set time is reached, the monitor will enter to the preset source automatically.

Use the **▲+** or **▲-** button to select **On program**, **AV1**, **RGB**, **AV2**, **AV3**, **PC**, **DVI** or **Network**.

## Setup menu

Press the **MENU** button and select **Setup** using the **P▲** or **P▼** buttons, press the **▲+** or **▲-** button to enter. Press the **BACK** button to return to the previous menu. Press the **MENU** button to exit.

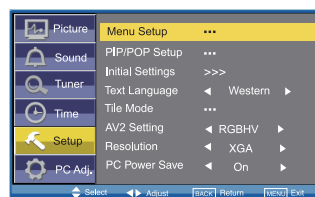

### Menu Setup

Whenever Setup menu is accessed initially, Menu Setup will be the default selection. Press the **▲+** or **▲-** button to enter the sub menu.

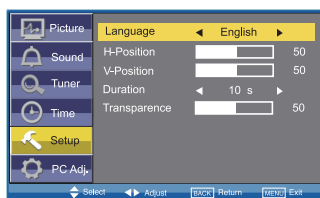

**Language** is used to select the preferred language. Use the **▲+** or **▲-** button to select **English, French, German, Italian, Spanish or Dutch.**

**H-Position** changes the OSD position horizontally by using the **▲+** or **▲-** button.

**V-Position** changes the OSD position vertically by using the **▲+** or **▲-** button.

**Duration** is used to set the display time of the MENU by using the **▲+** or **▲-** button. (5 ~ 120 seconds)

**Transparency** is used to adjust transparency of menu display. Use the **▲+** or **▲-** button to adjust levels.

**PIP/POP Setup**

Use the **PA** or **PV** button to select **PIP/POP Setup** and press the **▲+** or **▲-** button to enter the sub menu.

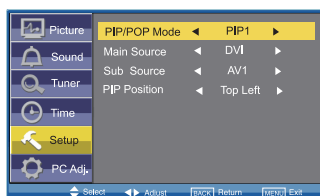

**PIP/POP Mode:** Using the **▲+** or **▲-** button select the most suitable mode **PIP1, PIP2, POP** or **Off**. (Please refer to page 13.)

When Mode is set to **Off**, **Sub Source** and **PIP Position** will not work.

**Main Source** is used to select input source (AV1, RGB, AV2, AV3, PC, DVI or Network ) for main picture by using the **▲+** or **▲-** button.

**Sub Source** is used to select input source (AV1, AV2, AV3, PC or DVI) for sub picture by using the **▲+** or **▲-** button.

For a combination of main picture and sub picture: only DVI or Network input can assemble with other input source. For example, if main source is selected as AV1 input, then the sub source must be DVI or Network input.

**PIP Position:** Using the **▲+** or **▲-** button it can be selected **Top Left, Top Right, Bottom Right** or **Bottom Left**.

**Initial Settings**

This function returns all setting values **except for** Installation Mode.

**Text Language**

Use the **PA** or **PV** button to select **Text Language** and press the **▲+** or **▲-** button to select **Western, Eastern, Russian, Arabic** or **Farsi**.

**Tile Mode**

This function allows you to split an image to suit your monitor grid format to create a video wall.

Use the **PA** or **PV** button to select **Tile Mode** and press the **▲+** or **▲-** button to enter the sub menu as follows.

**Tile Mode Active** can be set **On** or **Off** using the **▲+** or **▲-** button.

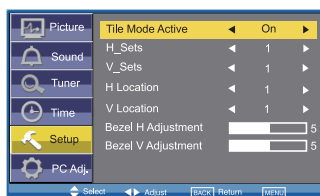

**H\_Sets** is used to divide the horizontal picture into more than one part, but the most is 5 parts (5 monitors).

**V\_Sets** is used to divide the vertical picture into more than one part, and the most is also 5 parts (5 monitors). Using the **▲+** or **▲-** button to set.

**H Location** is used to select one part of the horizontal picture to display on the current LCD Monitor using the **▲+** or **▲-** button.

**V Location** is used to select one part of the vertical picture to display on the current LCD Monitor using the **▲+** or **▲-** button.

**Bezel H Adjustment** is used to align the image horizontally with respect to the other monitors in the video wall to accommodate the bezel width using the **▲+** or **▲-** button. (0 ~ 10)

**Bezel V Adjustment** is used to align the image vertically with respect to the other monitors in the video wall to accommodate the bezel width using the **▲+** or **▲-** button. (0 ~ 10)

**AV2 Setting**

Use the **PA** or **PV** button to select **AV2 Setting** and press the **▲+** or **▲-** button to select **YpBPr** or **RGBHV**.

Connect your PC to either PC-IN or RGBHV on the rear of the set. Once connected select PC mode or AV2 (RGBHV, see page 5 for AV2 input settings) via the **INPUT** button on your remote control. The set will become a monitor for the PC.

**Native Resolution**

Use the **PA** or **PV** button to select **Native Resolution** and press the **▲+** or **▲-** button to select **XGA** or **WXGA 1366 x 768**.

**PC Power Save**

The monitor set automatically turns off with no PC input signal and wakes up with signal while PC Power Save is active.

Use the **PA** or **PV** button to select PC Power Save and press the **▲+** or **▲-** button to select **ON** or **OFF**.

**PC Adj. menu**

Press the **MENU** button and select **PC Adj.** using the **PA** or **PV** buttons, press the **▲+** or **▲-** button to enter. Press the **BACK** button to return to the previous menu. Press the **MENU** button to exit menu operation.

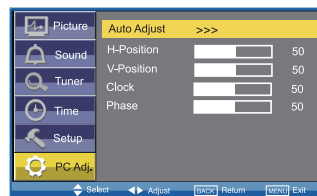

**Auto Adjust** is used to automatically detect incoming signal, and adjust itself to optimize its performance by using the **▲+** or **▲-** button. If the image is not displayed properly, a manual adjustment is required (Refer to following adjustments).

**H-Position** is used to move the horizontal picture position by using the **▲+** or **▲-** button.

**V-Position** is used to move the vertical picture position by using the **▲+** or **▲-** button.

**Clock** is used to eliminate flicker from the image by using the **▲+** or **▲-** button.

**Phase** is used to eliminate disorder from the image by using the **▲+** or **▲-** button.

## Installation Mode

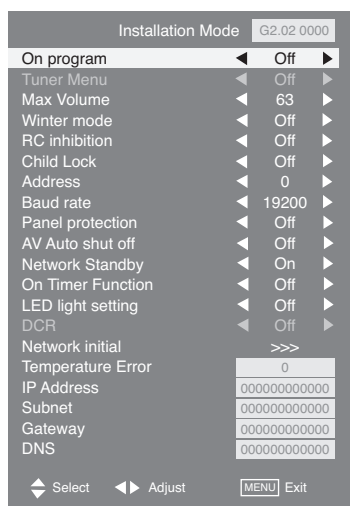

This LCD monitor allows you to set up the following:

### SETTING PROCEDURE

1. Press and hold the **GREEN button** on the remote control for 5 seconds. (Installation Mode will appear)
2. Use the **P▲** or **P▼** button to highlight each option, use the **▲+** or **▼-** button to adjust each option. Press the **MENU** button to exit the mode.

#### ■ On Program

Select ON program using the **P▲** or **P▼** button, select the start up position using the **▲+** or **▼-** buttons.  
(Off/AV1/RGB/AV2/AV3/PC/DVI or Network)

#### ■ Max Volume

Select Max volume using the **P▲** or **P▼** button, use the **▲+** or **▼-** buttons to set the maximum volume required.

#### ■ Winter mode

This Function can be activated when the LCD monitor is used during cold temperature conditions, approximately 38°F/4°C or below to maintain picture performance.

Using the **P▲** or **P▼** button select winter mode, once highlighted you can select ON or OFF by pressing the **▲+** or **▼-** button.

**IMPORTANT:** The AC cord should not be disconnected during the operation of Winter mode function.

When in winter mode, power consumption is higher than normal standby consumption. This is entirely due to the operation of heating circuitry. We strongly recommend to turn off Winter mode when the ambient temperature is above 38°F/4°C.

#### ■ RC inhibition

You can prevent unwanted remote control operation by selecting RC Inhibition.

Select using the **P▲** or **P▼** button. Press the **▲+** or **▼-** button to select On or Off.

To re-instate RC operation press and hold the green button on the remote control and select RC inhibition OFF.

#### ■ Child Lock

You can prevent unwanted operation of the LCD monitor via the buttons on the rear of the monitor.

Select using the **P▲** or **P▼** button. Press the **▲+** button to select On or OFF. The "Child Lock" OSD will appear if buttons are pressed when child lock is On.

☞ Standby operates normally when childlock is set "On".

#### ■ Address

Set the address for the LCD monitor (0 ~ 999).

#### ● Setting the monitor address in RS232 mode

Each monitor can have a specific Address, which helps command that monitor individually and will not effect to other monitors connected to a controlling PC Address format command.

The addressing format command is used for operating multiple monitor sets from a single PC via the RS232C command line.

#### ■ Baud rate

Select Baud rate using the **P▲** or **P▼** button. To set transmission speed RS232 or LD-NET communication for 19200 or 9600 Baud rate by pressing the **▲+** or **▼-** button.

#### ■ Panel protection

To prevent image sticking which may occur showing still picture for a long time, select "Panel Protect" using the **P▲** or **P▼** button, once highlighted you can select ON or OFF by pressing the **▲+** or **▼-** button.

#### ■ AV Auto shut off

With no picture input signal to AV1, RGB, AV2(YPbPr), AV3, DVI, Network, set turns off automatically. Select "AV Auto Shut Off" using the **P▲** or **P▼** button, once highlighted you can select On or Off by pressing the **▲+** or **▼-** button.

#### ■ Network Standby

You can save power consumption selecting "Off" at Network Standby in Installation mode, both RS232C and LD-NET do not functional. To make them functional, select "ON" in this menu.

#### ■ On Timer Function

You can save power consumption selecting "Off" at On Timer function in Installation mode. On Timer in Time menu does not functional. To make them functional, select "ON" in this menu.

#### ■ LED Light setting

Select LED Light setting using the **P▲** or **P▼** button, once highlighted you can select On or Off by pressing the **▲+** or **▼-** button.

#### ■ DCR

The picture contrast improved while DCR is ON. Select DCR using the **P▲** or **P▼** button, once highlighted you can select On or Off by pressing the **▲+** or **▼-** button.

#### ■ Network Initial

This function automatically installs the IP Address, Subnet, Gateway and DNS information.

#### ■ Temperature Error

The recorded number of abnormal temperature is occurred is indicated here.

#### ■ IP Address/Subnet/Gateway/DNS

These 4 items display the LD-Net information. If LD-NET is NOT connected, all the items would be displayed as "000000000000".

☞ Disconnecting the mains supply before exiting Installation Mode will cancel the following features On program, RC inhibition, Address and Baud Rate.

## Selection of picture size

Select screen size from FULL, FULL ALL, ZOOM 16:9, TITLE IN 16:9, ZOOM 14:9, TITLE IN 14:9, NORMAL or NATURAL WIDE by pressing the WIDE button repeatedly on the Remote Control.

✎ When in AV2 (RGBHV) or PC mode FULL or NORMAL can be selected.

**Note:** Full - Set display area 100%





✎ Only in DVI or AV2 (YPbPr) displaying high resolution content FULL and FULL ALL are selectable.

**Note:** FULL - Set display area 95%





FULL ALL - Set display area 100%

All other inputs AV1, AV3, DVI or AV2 (YPbPr) (displaying lower resolutions) can select all picture sizes.





### ■ Full/Full All

4:3	14:9	16:9	Letterbox Video
			
The whole screen is filled stretching the width.	The whole screen is filled stretching the height slightly at the edges.	The whole screen is filled with the correct picture ratio.	The black bars top and bottom are present and the height is compressed.





### ■ Title In 14:9

4:3	14:9	16:9	Letterbox Video
			
As zoom (14:9), but bottom is compressed even more to allow subtitles to be seen.	As zoom (14:9), but bottom is compressed even more to allow subtitles to be seen.	As zoom (14:9), but bottom is compressed even more to allow subtitles to be seen.	As zoom (14:9), but bottom is compressed even more to allow subtitles to be seen.





### ■ Zoom 16:9

4:3	14:9	16:9	Letterbox Video
			
The correct picture width is maintained but the top and bottom are cropped.	Zooms in slightly cropping the top and bottom.	Zooms in slightly cropping the top and bottom.	The black bars top and bottom are smaller and the picture height is compressed slightly.





### ■ Normal

4:3	14:9	16:9	Letterbox Video
			
The correct ratio is maintained with black bars on the left and right.	Black bars left and right, picture height is stretched.	Black bars left and right, picture height is stretched.	Black bars left, right, top and bottom.





### ■ Title in 16:9

4:3	14:9	16:9	Letterbox Video
			
As Zoom (16:9), but bottom is compressed even more to allow subtitles to be seen.	As Zoom (16:9), but bottom is compressed even more to allow subtitles to be seen.	As Zoom (16:9), but bottom is compressed even more to allow subtitles to be seen.	As Zoom (16:9), but bottom is compressed even more to allow subtitles to be seen.

### ■ Natural Wide

4:3	14:9	16:9	Letterbox Video
			
Stretches the picture horizontally to fill the screen. The picture is more stretched at the edges.	The height is expanded to fill the whole screen.	The picture fills the screen and is proportionally correct.	The black bars top and bottom remain and the height is compressed to fit the picture area.

### ■ Zoom 14:9

4:3	14:9	16:9	Letterbox Video
			
The correct picture width is maintained but the top and bottom are cropped.	Zooms in slightly cropping the top and bottom.	Zooms in slightly cropping the top and bottom.	The black bars top and bottom are smaller and the picture height is compressed slightly.

## PIP/POP Operation

Using this function, you can enjoy a **DVI** or **Network** program and an image (**AV1**, **AV2**, **AV3** or **PC** input) at the same time.

Press the **ON/OFF** button on the Remote Control repeatedly to select **PIP1**, **PIP2**, **POP** or **OFF** mode.

During the PIP/POP mode, press the **Main/Sub Picture Swap button** will switch the location for main and sub picture.

- ☞ Only the sound on the main picture is heard from the monitor speaker. The sound on the sub-picture cannot be heard.
- ☞ The details for PIP/POP operation (eg, location for sub picture or input source for any picture, etc.), please refer to page 10.

### ■ PIP1 mode

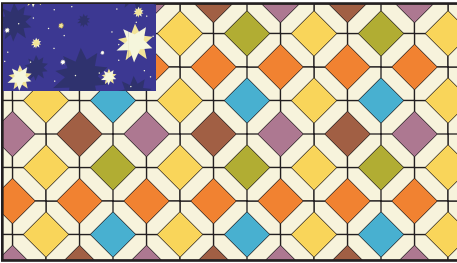

### ■ PIP2 mode

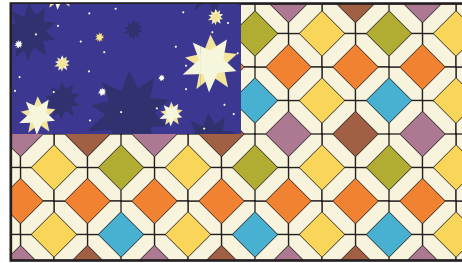

### ■ OFF mode

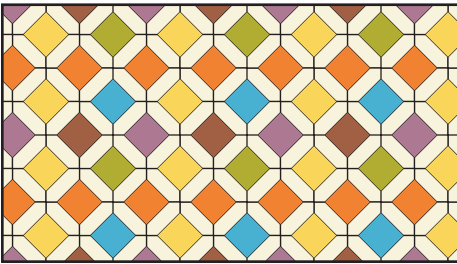

### ■ POP mode

The left picture is main picture, the right picture is sub picture.

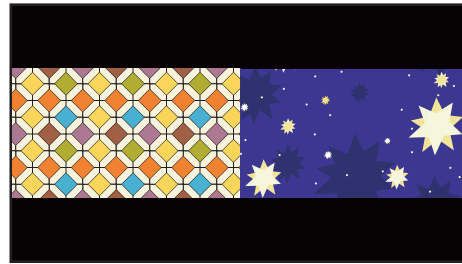

## Teletext Operation

Teletext is only available via external sources.  
Teletext mode can be operated by the following buttons on the Remote Control.

Some buttons have dual functions.

### **TXT/TV**

Press TXT/TV button to select teletext. Press again will display:  
AV mode: AV/TEXT mode/MIX mode/AV.

#### **Note:**

**MIX mode:** AV (broadcast image) screen and the contents of TEXT (superimposed) are displayed simultaneously.

**CANCEL mode:** TEXT/MIX MODE is cancelled temporarily and AV image is displayed.

If the signal is removed or disconnected, the monitor will revert to a blue background with "No signal" message on the screen.

If the TXT/TV button is pressed during the CANCEL mode, the CANCEL mode will be cancelled, and full text will resume.

### **Text Subcode**

Press this button, "110/. . ." will be displayed (e.g. the current page is 110).

And press the NUMERIC buttons(0 ~ 9) to enter the sub page.

For example, to select sub page 4, press NUMERIC buttons 0 - 0 - 0 - 4, and "110/0004" will be displayed.

When finished, press the text subcode button to return to normal operation.

### **Text Index**

Press this button to select one of the teletext index pages in TEXT, MIX or CANCEL mode.

### **Text Red**

Use to select the red topic or page number at the bottom of the text page.

### **Text Green**

Use to select the green topic or page number at the bottom of the text page.

### **Text Yellow**

Use to select the yellow topic or page number at the bottom of the text page.

### **Text Blue**

Use to select the blue topic or page number at the bottom of the text page.

### **Text Cancel**

Press the TEXT CANCEL button in TEXT or MIX mode, the TV picture appears on the screen.

Press this button once again or press TXT/TV button, CANCEL mode will be cancelled.

In CANCEL mode, "CAN" is always displayed on the upper left of the screen.

### **Text Hold**

Press Text Hold button to stop page request and updating.

#### **HOLD ON:**

The Hold symbol will appear instead of the page number.

Update of TELETEXT is forbidden. It holds on the current TEXT screen display now.

#### **HOLD OFF:**

The hold symbol is replaced with the page number.

TELETEXT page data is updated.

The present page is re-requested. (header roll)

Text Hold button will only work whilst in TEXT Mode.

### **Text Reveal**

Press **Text Reveal** button to reveal hidden items on the text page.

Some pages such as quiz pages have the answers hidden. The button may have to be held to keep the answer on the screen, or press again to remove the answer.

In Reveal OFF, this indication is not given.

**Text Reveal button** will only work whilst in text mode.

### **Page Up and Down**

To select the next or previous page.

### **Volume Up/Down**

To adjust the sound volume level.

### **Text Size**

Press Text Size button to enlarge the top half of the text page.

Press Text Size button again to enlarge the bottom half of the text page.

Press Text Size button again to return to the normal size page.

(Normal/top half enlargement/bottom half enlargement/normal)

#### **Note:**

During the top half or bottom half enlargement mode, if a page request is performed by [0 ~ 9] numeric buttons or the TEXT INDEX button, it will return to normal mode and a page will be requested.

If HOLD ON/OFF is performed during the top half enlargement mode, it will hold the top half enlargement mode. (HOLD symbol will display)

If HOLD ON/OFF is performed during the bottom half enlargement mode, it will hold the bottom half enlargement mode. (HOLD symbol will NOT display)

### Specification

#### Common specification

**Power source:** 100 ~ 240V 50Hz/60Hz

**Colour system:** PAL/NTSC/NTSC4.43/SECAM

#### AV terminal

**AV1:** Scart CENELEC Standard

**Input:** Composite video, RGB (5V RGB with 5V sync to pin 14) and audio-L/R

**Output:** composite video from AV3 and audio L/R

**AV2:** BNC

**Input:** RGB, H and V/Y, Pb, Pr and audio L/R

**Output:** RGB, H and V/Y, Pb, Pr

**AV3:** BNC

**Input:** Composite video

**Output:** Composite video

**Audio Monitor Out:** CINCH L/R

**Audio Speaker Out:** 42" model 2 x 6W  
52" model 2 x 8W

#### DVI

**Input:** DVI-D GROUP Standard

#### PC

**Input:** Mini D-SUB 15 PIN and Audio 3.5mm Jack

**Serial Port:** RS232C: Input/Output

**Net Organiser:** POA-LN02 (optional)

When ordering these products, give the Name and Type No. to the sales dealer.

### Helpful hints

#### ■ NO PICTURE NO SOUND

- Check if monitor is plugged in.
- Check monitor is not in standby mode.

#### ■ POOR PICTURE

- Adjust BRIGHTNESS/CONTRAST levels (too low).

#### ■ NO COLOUR, PICTURE OK

- Adjust COLOUR control.
- Check lead connections.
- Does the signal input have colour.

#### ■ REMOTE CONTROL DOES NOT WORK

- Check batteries are inserted correctly.
- Check condition of batteries.
- Check to see if remote control inhibit is set ON.

#### ■ PICTURE OK, NO SOUND

- Check external speakers are connected correctly.
- Check lead connections to external equipment.
- Check volume turned down or mute selected.

Model name	Contrast Ratio	Screen (inches/cm) (viewing measured diagonally)	Display Native Resolution	Viewing angles	Dimension (W x H x D)	Weight (kg)
CE42LM6R	1200:1	42"/106.7 cm	1366 x 768	H: 178°, V: 178°	1027 x 620 x 178.5 mm	32
CE42LM6DPE						33
CE42LM6WP	1200:1 (DCR ON)				1027 x 620 x 183 mm	39
CE42SR2						39
CE52LH2R	2000:1	52"/132 cm	1920 x 1080		1304 x 800 x 232 mm	65
CE52LH2WP						83
CE52SR2				83		

● The specifications are subject to change without notice.

● LCD panels are manufactured to the highest possible standards. Even though 99.99% of the pixels are effective, a tiny fraction of the pixels (0.01% or less) may be ineffective by the characteristics of the LCD panels.

■ CE42SR2

Unit: mm

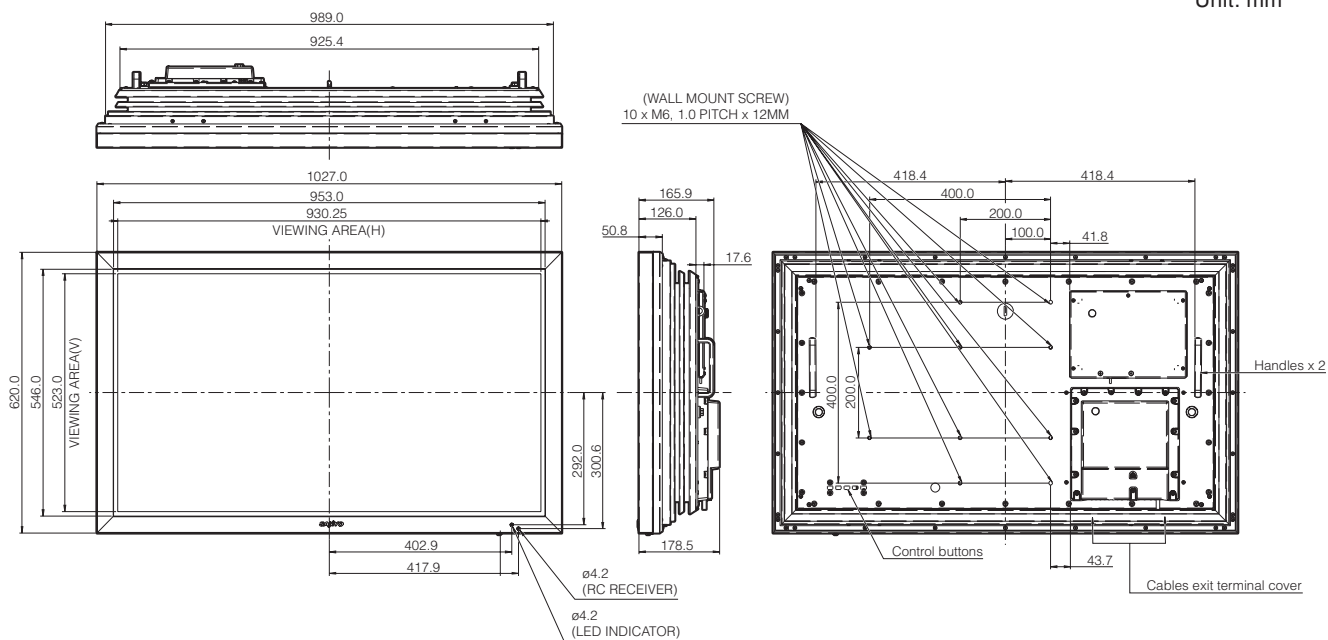

■ CE52SR2

Unit: mm

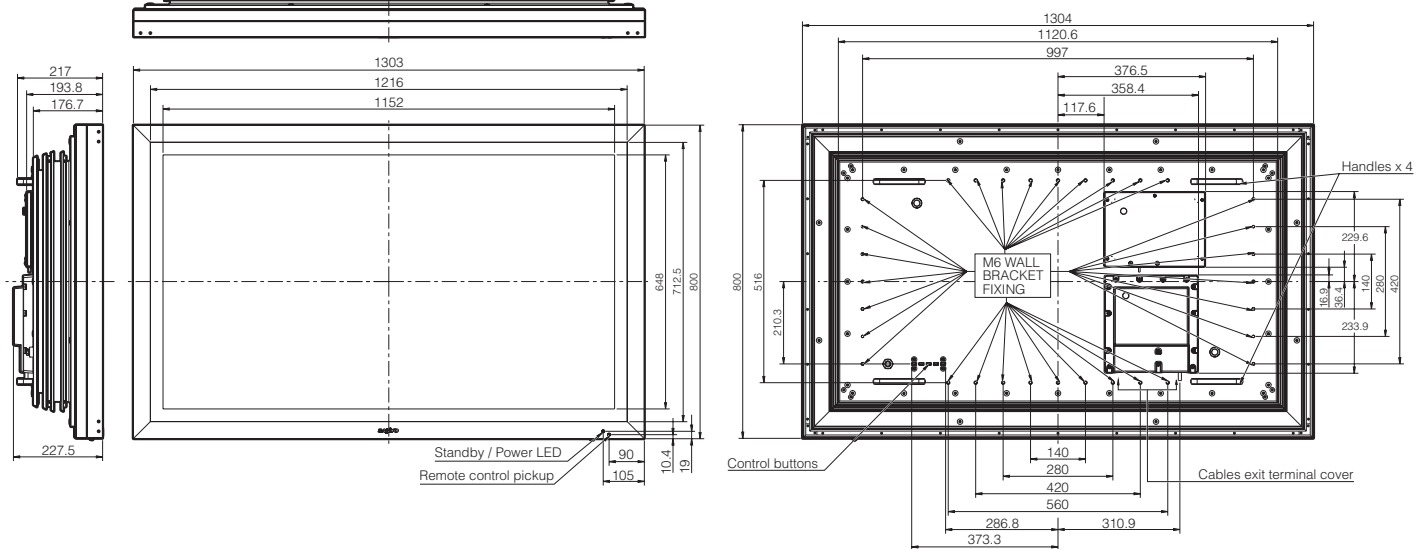



## ■ PC signal support timing

Resolution	Horizontal Frequency (kHz)	Vertical Frequency (Hz)	Remark
720 x 400	31.47	70.09	DOS (VGA)
640 x 480	31.43	59.88	VGA VESA 60Hz
640 x 480	37.50	75.00	VGA VESA 75Hz
640 x 480	37.86	72.81	VGA VESA 72Hz
640 x 480	43.27	85.00	VGA VESA 85Hz
640 x 480	35.00	66.67	Mac. 13
640 x 480	34.97	66.60	Mac LC 13"
800 x 600	35.16	56.25	SVGA VESA 56Hz
800 x 600	37.88	60.32	SVGA VESA 60Hz
800 x 600	46.875	75.00	SVGA VESA 75Hz
800 x 600	34.50	55.38	SVGA
800 x 600	38.00	60.51	SVGA
800 x 600	53.67	85.06	SVGA VESA 85Hz
832 x 624	49.72	74.55	Mac. 16
1024 x 768	48.36	60.00	XGA VESA 60Hz
1024 x 768	56.47	70.07	XGA VESA 70Hz
1024 x 768	60.02	75.03	XGA VESA 75Hz
1024 x 768	48.50	60.02	XGA
1024 x 768	60.31	74.92	XGA
1024 x 768	61.00	75.70	XGA
1024 x 768	68.68	85.00	XGA VESA 85Hz
1024 x 768	60.24	75.08	MAC_Normal 19"
1280 x 720	37.5	50.00	720p - 50Hz
1280 x 960	60.00	60.00	SXGA VESA 60Hz
1280 x 1024	79.976	75.025	SXGA VESA 75Hz
1280 x 1024	63.370	60.01	SXGA
1280 x 1024	63.34	59.98	SXGA
1280 x 1024	63.74	60.01	SXGA
1280 x 1024	63.79	60.18	SXGA
1280 x 1024	63.90	60.00	SXGA
1280 x 1024	81.13	76.107	SXGA
1152 x 900	61.20	65.20	SXGA
1152 x 900	61.85	66.00	SXGA
1152 x 900	71.40	75.60	SXGA
1400 x 1050	65.35	60.12	SXGA +
1400 x 1050	65.12	59.90	SXGA +
1152 x 870	68.68	75.06	MAC_Normal 21"
1280 x 1024	80.00	75.00	Mac II
1600 x 1200	75.00	60.00	UXGA VESA 60Hz
1366 x 768	48.36	60.01	WXGA
1360 x 768	47.73	60.03	WXGA
1920 x 1080	28.125	50.00	1080i - 50Hz
1920 x 1080	33.75	60.00	1080i - 60Hz

The monitor can be automatically adjusted in pc mode when receiving a standard VESA signal. It will be displayed as XGA when the monitor is receiving a XGA or WXGA signal.

## ■ DVI-D signal support timing

Resolution	Horizontal Frequency (kHz)	Vertical Frequency (Hz)	Remark
640 x 480	31.43	59.88	VGA VESA 60Hz
640 x 480	37.86	72.81	VGA VESA 72Hz
640 x 480	37.5	75	VGA VESA 75Hz
640 x 480	34.97	66.6	MAC LC 13"
640 x 480	35	66.67	MAC_NORMAL 13"
800 x 600	35.16	56.25	SVGA VESA 56Hz
800 x 600	37.88	60.32	SVGA VESA 60Hz
800 x 600	46.875	75	SVGA VESA 75Hz
832 x 624	49.72	74.55	MAC_NORMAL 16"
1024 x 768	48.36	60	XGA VESA 60Hz
1024 x 768	60.23	75.03	XGA VESA 75Hz
1024 x 768	56.47	70.07	XGA VESA 70Hz
1024 x 768	60.24	75.08	MAC_NORMAL 19"
1152 x 870	68.68	75.06	MAC_NORMAL 21"
1280 x 1024	63.98	60.02	SXGA VESA 60Hz
720 x 480	31.7	59.94	480p
720 x 480	15.73	59.94	480i
768 x 575	31.25	50	575p
768 x 575	15.63	50	575i
1280 x 720	37.5	50	720p - 50Hz
1280 x 720	45	60	720p - 60Hz
1366 x 768	48.36	60	WXGA
1360 x 768	47.7	60	WXGA
1920 x 1080	28.125	50	1080i - 50Hz
1920 x 1080	33.75	60	1080i - 60Hz
1920 x 1080	56.25	50	HDTV 1080p - 50Hz
1920 x 1080	67.5	60	HDTV 1080p - 60Hz
1920 x 1080	27.00	24	HDTV 1080p - 24Hz
1920 x 1080	28.13	25	HDTV 1080p - 25Hz
1920 x 1080	33.75	30	HDTV 1080p - 30Hz

Depending on the condition of signals and the type and length of cables, these signals may not be properly viewed.  
To save the native resolution **1366 x 768** setting switch the monitor off then on using the standby button.

## ■ Component signal support timing

Resolution	Horizontal Frequency (kHz)	Vertical Frequency (Hz)	Remark
720 x 480	15.735	60i	SDTV 480i
720 x 576	15.625	50i	SDTV 576i
720 x 480	31.25	60p	SDTV 480p
720 x 576	31.25	50p	SDTV 576p
1280 x 720	45.00	60p	HDTV 720p
1280 x 720	37.50	50p	HDTV 720p
1920 x 1080	33.75	60i	HDTV 1080i
1920 x 1080	28.13	50i	HDTV 1080i

### ■ Functional Execution Command Table

Command	Item
C00	POWER ON
C01	POWER OFF
C24	Wide "Natural" direct
C25	Wide "Zoom 16:9" direct
C26	Wide "Title in 16:9" direct
C27	Wide "Zoom 14:9" direct
C28	Wide "Title in 14:9" direct
C29	Wide "Full" direct
C0F	Wide "Normal" direct
C70	AV1 direct
C71	RGB direct
C72	AV2 RGBHV direct
C73	AV2 YPbPr direct
C74	AV3 direct
C75	DVI direct
C76	PC direct
C64	PC Auto adjust
C92	Factory settings
CF PSAVE ON	Power save ON
CF PSAVE OFF	Power save OFF
CF CLOK ON	Child lock ON
CF CLOK OFF	Child lock OFF
CF DEA RMCY	RC inhibition OFF
CF DEA RMCN	RC inhibition ON

### ■ Image control Read Command Table

Status read command	Item
CR BRIGHT	Status of Brightness.
CR CONT	Status of Contrast.
CR COLOR	Status of Color.
CR TINT	Status of Tint.
CR SHARP	Sharpness.
CR WBAL	Status of White Balance Mode information.
CR WBAL-R	Status of White Balance Red.
CR WBAL-G	Status of White Balance Green.
CR WBAL-B	Status of White Balance Blue.
CR NZRED	Status of Noise reduction setting.
CR FILM	Status of Film mode setting.
CR IMAGE	Status of Image selection. (The same as PICTURE mode)
CR DCDI	Status of DCDi setting.
CR ACCACM	Status of ACC/ACM setting.
CR CCS	Status of CCS setting.
CR MPEGNR	Status of MPEG NR setting.

### ■ PC Read Command Table

Status read command	Item
CR H-POS	Status of Horizontal position.
CR V-POS	Status of Vertical position.
CR PHASE	Status of PHASE value.
CR CLOCK	Status of CLOCK value.

### ■ Input Read Command Table

Status read command	Item
CR INPUT	Status of Input selection.
CR SOURCE	Status of Input source mode.
CR SYSTEM	Status of system of Input mode.

### ■ Screen Read Command Table

Status read command	Item
CR SCREEN	Status of screen size. (The same of WIDE mode)

### ■ Time Read Command Table

Status read command	Item
CR PANELH	Status of accumulated lifetime of panel. (The same as CR_LAMPH Command)
CR MONH	Status of accumulated lifetime of monitor. (The same as CR_PROJH Command)

### ■ Sound control Read Command Table

Status read command	Item
CR VOLUME	Status of volume value.
CR MUTE	Status of MUTE.

### ■ Setting Read Command Table

Status read command	Item
CR LANG	Status of Language selection.
CR P-MANE	Status of Power management setting.
CR TILE	Status of Tile mode ON/OFF setting.
CR TILE-HSETS	Status of Tile mode, the number of Horizontal array.
CR TILE-VSETS	Status of Tile mode, the number of Vertical array.
CR TILE-HLOCAT	Status of Tile mode, the number of Horizontal allocation.
CR TILE-VLOCAT	Status of Tile mode the number of Vertical allocation.
CR TILE-BZLHADJ	Status of Tile mode, the width of bezel (Horizontal).
CR TILE-BZLVADJ	Status of Tile mode, the width of bezel (Vertical).
CR ONPROG	Status of On Program information.
CR WINTERMODE	Status of Winter mode Information.
CR PANELPROTECT	Statuses of Panel protect Information.
CR LEDLIGHT	Status of LED light Information.
CR AVAUTOSHUT	Status of AV auto shut OFF Information.
CR CHILDLOCK	Statuses of Child lock Information.
CR RCINHIBITION	Status of RC Inhibit Information.

### ■ Other Read Command Table

Status read command	Item
CR STATUS	Status of the operation of the monitor.
CR SIGNAL	Status of with or without signal.
CR FREEZE	Status of Freeze setting.
CR FANLOCK	Statuses of fan lock error.
CR TEMP	Status of current temperature value.

### ■ UK5 Read Command Table (Basic Command)

Command	Item	Note
CR0	Power	On, Standby, power error,
CR1	Input Mode	AV1, AV2, . . . , DVI, PC
CR WIDE	Wide mode	Auto, Normal, Full, . . .
CR PICTURE	Picture mode	Dynamic, Standard, . . .
CR SIGNAL	Signal existence	Signal/No signal
CR CHILD	Child lock	On/Off
CR PSAVE	Power save	On/Off
CRTM	Panel usage time	—
CR RMC	RC inhibition	On/Off
CR MDL	Model number	Model number

### ■ Error code Table

Error code	Note
?	<ul style="list-style-type: none"> <li>Receiving the data that cannot be decoded.</li> <li>The wrong indication of parameter. (Wrong figured number, or wrong word is included)</li> </ul>
000	Normal receiving. (no error)
102	If the command of out of range is directly entered valuable parameter.
103	No matching with Hardware. (Command for optional function which is not equipped)
201	If the command of "Out of range" is entered by increment or decrements by numeric value.
301	While capturing the picture, no execution. Wait and transmit command again.
402	While PIN code is in operation, no execution. Wait and transmit command again.
101	The errors not including above.

