



Multimedia Projector

MODEL PLC-XU3001

Network Supported

- Wired LAN

Refer to the Owner's Manuals below for details about network function.

- Network Set-up and Operation

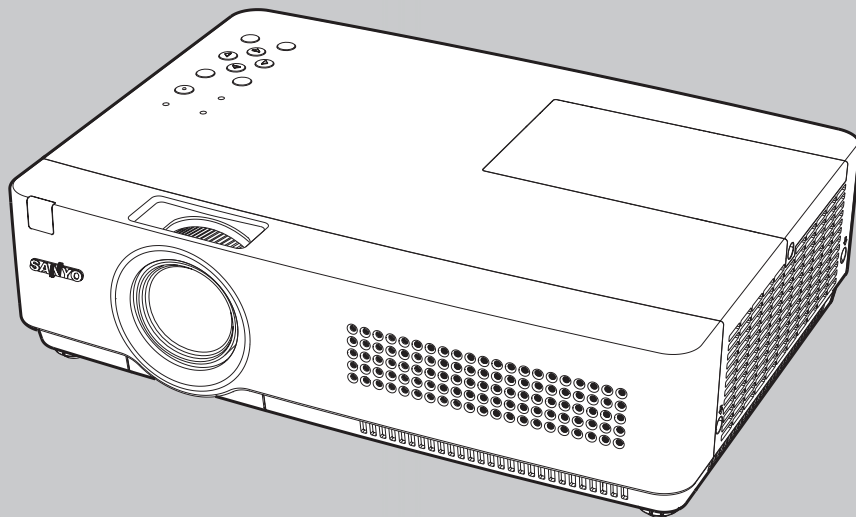

Owner's Manual



PROJECTOR

Features and Design

This Multimedia Projector is designed with the most advanced technology for portability, durability, and ease of use. This projector utilizes built-in multimedia features, a palette of 16.77 million colors, and matrix liquid crystal display (LCD) technology.

◆ **Compact Design**

This projector is designed compact in size and weight. It is easy to carry and installed anywhere you wish to use.

◆ **Simple Computer System Setting**

The projector has the Multi-scan system to conform to almost all computer output signals quickly (p.29). Up to WUXGA resolution can be accepted.

◆ **Useful Functions for Presentations**

- The digital zoom function allows you to focus on the crucial information during a presentation (p.36).
- Blackboards* can be used as a projection screen.
*The board color is limited to Green (pp.33, 40).

◆ **Lamp Control**

Brightness of the projection lamp can be selected (pp.25, 53).

◆ **Direct Off Function**

With the Direct Off function, you can disconnect the power cord from the wall outlet or turn off the breaker even during projection (p.20).

◆ **Logo Function**

The Logo function allows you to customize the screen logo (pp.47-49). You can capture an image for the screen logo and use it for the starting-up display or between presentations.

◆ **Multilanguage Menu Display**

Operation menu is available in 17 languages; English, German, French, Italian, Spanish, Portuguese, Dutch, Swedish, Finnish, Polish, Hungarian, Romanian, Russian, Chinese, Korean, Japanese and Thai (p.44).

◆ **Security Function**

The Security function helps you to ensure security of the projector. With the Key lock function, you can lock the operation on the top control or remote control (p.54). PIN code lock function prevents unauthorized use of the projector (pp.19, 54-55).

◆ **Helpful Maintenance Functions**

Lamp and filter maintenance functions provide for better and proper maintenance of the projector.

◆ **LAN Network Function**

This projector is loaded with the Wired LAN network function. You can operate and manage the projector via network. For details, refer to the owner's manual "Network Set-up and Operation."

◆ **Auto Setup Function**

This function enables Input search, Auto Keystone correction and Auto PC adjustment by simple pressing the AUTO SETUP button on the top control (p.45).

◆ **Colorboard Function**

At the time of simple projection on the colored wall, you can get the close color image to the color image projected on a white screen by selecting the similar color to the wall color from the preset four colors.

◆ **Power Management**

The Power management function reduces power consumption and maintains the lamp life (p.51).

◆ **Closed Caption**

Closed caption is a function that displays the audio portion of a TV program as text on the screen. The closed captioning service is available mainly in the U.S (p.50).

✓**Note:**

- The On-Screen Menu and figures in this manual may differ slightly from the product.
- The contents of this manual are subject to change without notice.

Table of Contents

Features and Design	2	Input Source Selection (RGB (PC digital), RGB (AV HDCP))	28
Table of Contents	3	Computer System Selection	29
To the Owner	4	Auto PC Adjustment	30
Safety Instructions	5	Manual PC Adjustment	31
Air Circulation	6	Image Mode Selection	33
Installing the Projector in Proper Position	6	Image Adjustment	34
Moving the Projector	6	Screen Size Adjustment	35
Compliance	7	Video Input	37
Part Names and Functions	8	Input Source Selection (Video, S-video)	37
Front	8	Input Source Selection (Component, RGB Scart 21-pin)	38
Back	8	Video System Selection	39
Bottom	8	Image Mode Selection	40
Rear Terminal	9	Image Adjustment	41
Top Control	10	Screen Size Adjustment	43
Remote Control	11	Setting	44
Remote Control Battery Installation	12	Setting	44
Remote Control Operating Range	12	Information	58
Remote Control Code	12	Input Source Information Display	58
Installation	13	Maintenance and Cleaning	59
Positioning the Projector	13	WARNING indicator	59
Adjustable Feet	13	Cleaning the Filters	60
Connecting to a Computer	14	Resetting the Filter Counter	60
Connecting to Video Equipment	15	Attaching the Lens Cap	61
Connecting to Component Video and RGB (Scart) Equipment	16	Cleaning the Projection Lens	61
Connecting the AC Power Cord	17	Cleaning the Projector Cabinet	61
Basic Operation	18	Lamp Replacement	62
Turning On the Projector	18	Appendix	64
Turning Off the Projector	20	Troubleshooting	64
How to Operate the On-Screen Menu	21	Menu Tree	68
Menu Bar	22	Indicators and Projector Condition	70
Zoom and Focus Adjustment	23	Compatible Computer Specifications	71
Auto Setup Function	23	Technical Specifications	73
Keystone Correction	23	Optional Parts	74
Sound Adjustment	24	PJ Link Notice	75
Remote Control Operation	25	Configurations of Terminals	76
Computer Input	27	PIN Code Number Memo	77
Input Source Selection (RGB: Computer 1/ Computer 2 (Analog))	27	Dimensions	78

Trademarks

Each name of corporations or products in this book is either a registered trademark or a trademark of its respective corporation.





To the Owner

Before installing and operating this projector, read this manual thoroughly.

This projector provides many convenient features and functions. Operating the projector properly enables you to manage those features and maintains it in good condition for many years to come.

Improper operation may result in not only shortening the product-life, but also malfunctions, fire hazard, or other accidents.

If your projector seems to operate improperly, read this manual again, check operations and cable connections and try the solutions in the "Troubleshooting" section in the back of this booklet. If the problem still persists, contact the dealer where you purchased the projector or the service center.

	CAUTION RISK OF ELECTRIC SHOCK DO NOT OPEN	
CAUTION: TO REDUCE THE RISK OF ELECTRIC SHOCK, DO NOT REMOVE COVER (OR BACK). NO USER-SERVICEABLE PARTS INSIDE EXCEPT LAMP REPLACEMENT. REFER SERVICING TO QUALIFIED SERVICE PERSONNEL.		
	THIS SYMBOL INDICATES THAT DANGEROUS VOLTAGE CONSTITUTING A RISK OF ELECTRIC SHOCK IS PRESENT WITHIN THIS UNIT.	
	THIS SYMBOL INDICATES THAT THERE ARE IMPORTANT OPERATING AND MAINTENANCE INSTRUCTIONS IN THE OWNER'S MANUAL WITH THIS UNIT.	

FOR EU USERS

The symbol mark and recycling systems described below apply to EU countries and do not apply to countries in other areas of the world.

Your product is designed and manufactured with high quality materials and components which can be recycled and/or reused.

The symbol mark means that electrical and electronic equipment, batteries and accumulators, at their end-of-life, should be disposed of separately from your household waste.

Note:

If a chemical symbol is printed beneath the symbol mark, this chemical symbol means that the battery or accumulator contains a heavy metal at a certain concentration. This will be indicated as follows: Hg: mercury, Cd: cadmium, Pb: lead

In the European Union there are separate collection systems for used electrical and electronic equipment, batteries and accumulators.

Please, dispose of them correctly at your local community waste collection/recycling centre. Please, help us to conserve the environment we live in!



Safety Precaution

- WARNING:**
- **THIS APPARATUS MUST BE EARTHED.**
 - **TO REDUCE THE RISK OF FIRE OR ELECTRIC SHOCK, DO NOT EXPOSE THIS APPLIANCE TO RAIN OR MOISTURE.**

- This projector produces intense light from the projection lens. Do not stare directly into the lens, otherwise eye damage could result. Be especially careful that children do not stare directly into the beam.
- Install the projector in a proper position. Otherwise it may result in fire hazard.
- Allowing the proper amount of space on the top, sides, and rear of the projector cabinet is critical for proper air circulation and cooling of the unit. The dimension shown here indicate the minimum space required. If the projector is to be built into a compartment or similarly enclosed, these minimum distances must be maintained.

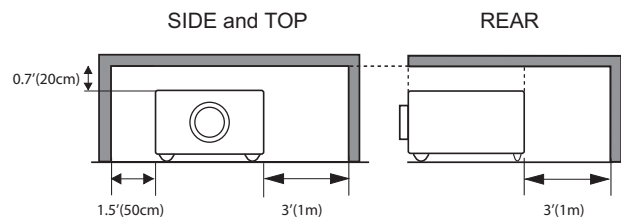

- Do not cover the ventilation slot on the projector. Heat build-up can reduce the service life of your projector, and can also be dangerous.
- If the projector is unused for an extended time, unplug the projector from the power outlet.
- Do not project the same image for a long time. The afterimage may remain on the LCD panels by the characteristic of panel.



CAUTION

DO NOT SET THE PROJECTOR IN GREASY, WET, OR SMOKY CONDITIONS SUCH AS IN A KITCHEN TO PREVENT A BREAKDOWN OR A DISASTER. IF THE PROJECTOR COMES IN CONTACT WITH OIL OR CHEMICALS, IT MAY BECOME DETERIORATED.

CAUTION

Not for use in a computer room as defined in the Standard for the Protection of Electronic Computer/Data Processing Equipment, ANSI/NFPA 75.

READ AND KEEP THIS OWNER'S MANUAL FOR LATER USE.

Safety Instructions

All the safety and operating instructions should be read before the product is operated.

Read all of the instructions given here and retain them for later use. Unplug this projector from AC power supply before cleaning. Do not use liquid or aerosol cleaners. Use a damp cloth for cleaning.

Follow all warnings and instructions marked on the projector.

For added protection to the projector during a lightning storm, or when it is left unattended and unused for long periods of time, unplug it from the wall outlet. This will prevent damage due to lightning and power line surges.

Do not expose this unit to rain or use near water... for example, in a wet basement, near a swimming pool, etc...

Do not use attachments not recommended by the manufacturer as they may cause hazards.

Do not place this projector on an unstable cart, stand, or table. The projector may fall, causing serious injury to a child or adult, and serious damage to the projector. Use only with a cart or stand recommended by the manufacturer, or sold with the projector. Wall or shelf mounting should follow the manufacturer's instructions, and should use a mounting kit approved by the manufacturers.

An appliance and cart combination should be moved with care. Quick stops, excessive force, and uneven surfaces may cause the appliance and cart combination to overturn.



Slots and openings in the back and bottom of the cabinet are provided for ventilation, to ensure reliable operation of the equipment and to protect it from overheating.

The openings should never be covered with cloth or other materials, and the bottom opening should not be blocked by placing the projector on a bed, sofa, rug, or other similar surface. This projector should never be placed near or over a radiator or heat register.

This projector should not be placed in a built-in installation such as a book case unless proper ventilation is provided.

Never push objects of any kind into this projector through cabinet slots as they may touch dangerous voltage points or short out parts that could result in a fire or electric shock. Never spill liquid of any kind on the projector.

Do not install the projector near the ventilation duct of air-conditioning equipment.

This projector should be operated only from the type of power source indicated on the marking label. If you are not sure of the type of power supplied, consult your authorized dealer or local power company.

Do not overload wall outlets and extension cords as this can result in fire or electric shock. Do not allow anything to rest on the power cord. Do not locate this projector where the cord may be damaged by persons walking on it.

Do not attempt to service this projector yourself as opening or removing Covers may expose you to dangerous voltage or other hazards. Refer all servicing to qualified service personnel.

Unplug this projector from wall outlet and refer servicing to qualified service personnel under the following conditions:

- When the power cord or plug is damaged or frayed.
- If liquid has been spilled into the projector.
- If the projector has been exposed to rain or water.
- If the projector does not operate normally by following the operating instructions. Adjust only those controls that are covered by the operating instructions as improper adjustment of other controls may result in damage and will often require extensive work by a qualified technician to restore the projector to normal operation.
- If the projector has been dropped or the cabinet has been damaged.
- When the projector exhibits a distinct change in performance-this indicates a need for service.

When replacement parts are required, be sure the service technician has used replacement parts specified by the manufacturer that have the same characteristics as the original part. Unauthorized substitutions may result in fire, electric shock, or injury to persons.

Upon completion of any service or repairs to this projector, ask the service technician to perform routine safety checks to determine that the projector is in safe operating condition.

NOTE FOR CUSTOMERS IN THE US

 LAMP(S) INSIDE THIS PRODUCT CONTAIN MERCURY AND MUST BE RECYCLED OR DISPOSED OF ACCORDING TO LOCAL, STATE OR FEDERAL LAWS.

Safety Instructions

Air Circulation

Openings in the cabinet are provided for ventilation. To ensure reliable operation of the product and to protect it from overheating, these openings must not be blocked or covered.

CAUTION

Hot air is exhausted from the exhaust vent. When using or installing the projector, the following precautions should be taken.

- Do not put any flammable object or spray can near the projector, hot air is exhausted from the air vents.
- Keep the exhaust vent at least 3' (1 m) away from any objects.
- Do not touch a peripheral part of the exhaust vent, especially screws and metallic parts. These areas will become hot while the projector is being used.
- Do not put anything on the cabinet. Objects put on the cabinet will not only get damaged but also may cause fire hazard by heat.

Cooling fans are provided to cool down the projector. The fans' running speed is changed according to the temperature inside the projector.

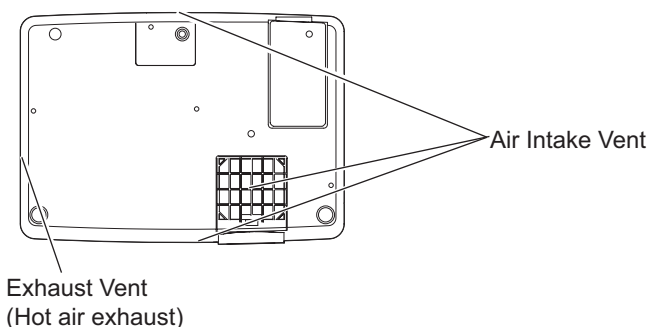
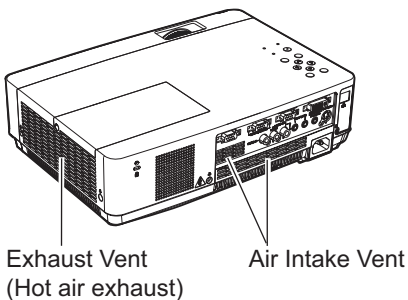
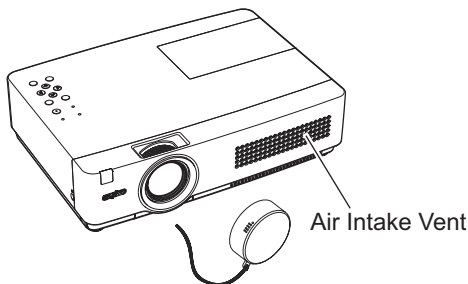

Installing the Projector in Proper Position

Install the projector properly. Improper installation may reduce the lamp life and cause a fire hazard.

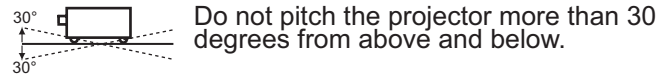
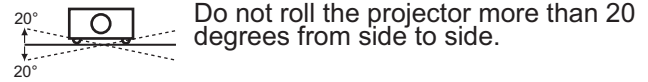

Do not point the projector up to project an image.



Do not point the projector down to project an image.



Do not put the projector on either side to project an image.

Moving the Projector

When moving the projector, replace the lens cap and retract adjustable feet to prevent damage to the lens and cabinet.

When the projector is not in use for an extended period, put it into the supplied carrying case with the lens side up.

CAUTION

The carrying case (supplied) is intended for protection against dust and scratches on surface of the cabinet, and it is not designed to protect an appliance from external forces. Do not transport the projector by courier or any other transport service with this case, otherwise the projector can be damaged. When handling the projector, do not drop, bump, subject it to strong forces, or put other things on the cabinet.

CAUTION IN CARRYING OR TRANSPORTING THE PROJECTOR

- Do not drop or bump the projector, otherwise damages or malfunctions may result.
- When carrying the projector, use a suitable carrying case.
- Do not transport the projector by courier or any other transport service in an unsuitable transport case. This may cause damage to the projector. For information about transporting the projector by courier or any other transport service, consult your dealer.
- Do not put the projector in a case before the projector is cooled enough.

Compliance

Federal Communications Commission Notice

Note: This equipment has been tested and found to comply with the limits for a Class B digital device, pursuant to Part 15 of the FCC Rules. These limits are designed to provide reasonable protection against harmful interference in a residential installation. This equipment generates, uses, and can radiate radio frequency energy, and if not installed and used in accordance with the instructions, may cause harmful interference to radio communications. However, there is no guarantee that interference will not occur in a particular installation. If this equipment does cause harmful interference to radio or television reception, which can be determined by turning the equipment off and on, the user is encouraged to try to correct the interference by one or more of the following measures:

- Reorient or relocate the receiving antenna.
- Increase the separation between the equipment and receiver.
- Connect the equipment into an outlet on a circuit different from that to which the receiver is connected.
- Consult the dealer or an experienced radio/TV technician for help.

Use of shielded cable is required to comply with class B limits in Subpart B of Part 15 of FCC Rules.

Do not make any changes or modifications to the equipment unless otherwise specified in the instructions. If such changes or modifications should be made, you could be required to stop operation of the equipment.

Model Number : PLC-XU3001
Trade Name : Sanyo
Responsible party : SANYO NORTH AMERICA CORPORATION
Address : 21605 Plummer Street, Chatsworth, California 91311
Telephone No. : (818)998-7322

AC Power Cord Requirement

The AC Power Cord supplied with this projector meets the requirement for use in the country you purchased it.

AC Power Cord for the United States and Canada:

AC Power Cord used in the United States and Canada is listed by the Underwriters Laboratories (UL) and certified by the Canadian Standard Association (CSA).

AC Power Cord has a grounding-type AC line plug. This is a safety feature to be sure that the plug will fit into the power outlet. Do not try to defeat this safety feature. Should you be unable to insert the plug into the outlet, contact your electrician.

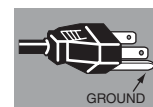

AC Power Cord for the United Kingdom:

This cord is already fitted with a moulded plug incorporating a fuse, the value of which is indicated on the pin face of the plug. Should the fuse need to be replaced, an ASTA approved BS 1362 fuse must be used of the same rating, marked thus \diamond . If the fuse cover is detachable, never use the plug with the cover omitted. If a replacement fuse cover is required, ensure it is of the same colour as that visible on the pin face of the plug (i.e. red or orange). Fuse covers are available from the Parts Department indicated in your User Instructions. If the plug supplied is not suitable for your socket outlet, it should be cut off and destroyed.

The end of the flexible cord should be suitably prepared and the correct plug fitted.

WARNING : A PLUG WITH BARED FLEXIBLE CORD IS HAZARDOUS IF ENGAGED IN A LIVE SOCKET OUTLET.

The Wires in this mains lead are coloured in accordance with the following code:

Green-and-yellow. . Earth
Blue Neutral
Brown Live

As the colours of the wires in the mains lead of this apparatus may not correspond with the coloured markings identifying the terminals in your plug proceed as follows:

The wire which is coloured green-and-yellow must be connected to the terminal in the plug which is marked by the letter E or by the safety earth symbol \perp or coloured green or green-and-yellow.

The wire which is coloured blue must be connected to the terminal which is marked with the letter N or coloured black.

The wire which is coloured brown must be connected to the terminal which is marked with the letter L or coloured red.

WARNING: THIS APPARATUS MUST BE EARTHED.

THE SOCKET-OUTLET SHOULD BE INSTALLED NEAR THE EQUIPMENT AND EASILY ACCESSIBLE.

Part Names and Functions

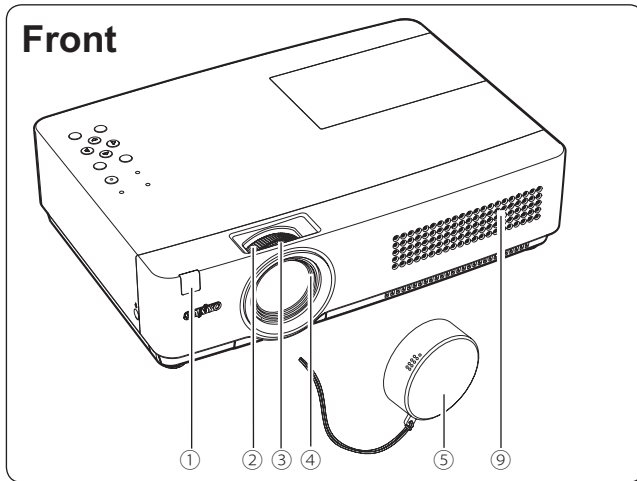

- ① Infrared Remote Receiver
- ② Zoom Ring
- ③ Focus Ring
- ④ Projection Lens

CAUTION

Do not cover the light beam in front of the lens. High temperature from light beam may damage the lens.

- ⑤ Lens Cap
(See page 61 for attaching.)

CAUTION

Do not turn on a projector with lens cap attached. High temperature from light beam may damage lens cap and result in fire hazard.

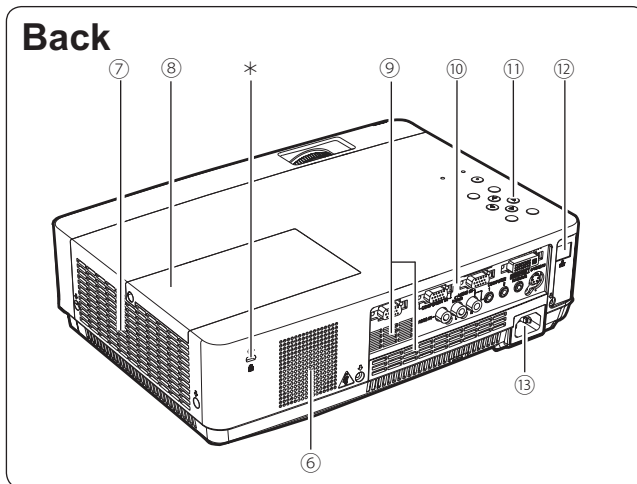

- ⑥ Speaker

- ⑦ Exhaust Vents

CAUTION

Hot air is exhausted from the exhaust vent. Do not put heat-sensitive objects near this side.

- ⑧ Lamp Cover
- ⑨ Air Intake Vent
- ⑩ Terminals and Connectors
- ⑪ Top Controls and Indicators
- ⑫ LAN Connection Terminal
- ⑬ Power Cord Connector
- ⑭ Filters
- ⑮ Adjustable Feet

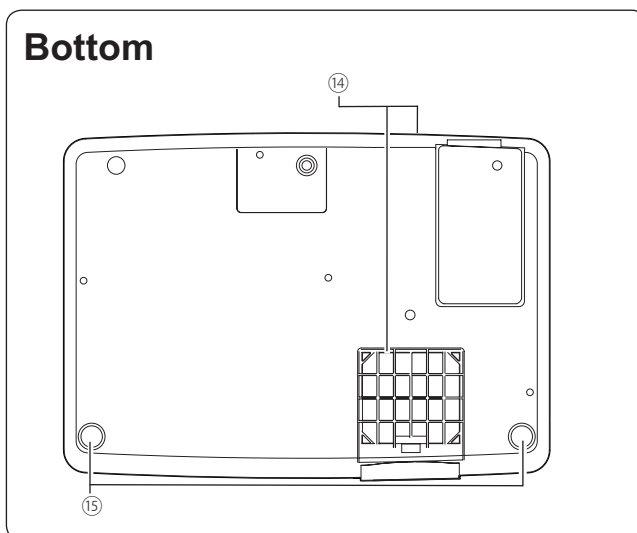

✓Note:

⑫ LAN Connection Terminal is for the Network function. Refer to the owner's manual of "Network Set-up and Operation".

*** Kensington Security Slot**

This slot is for a Kensington lock used to deter theft of the projector.

*Kensington is a registered trademark of ACCO Brands Corporation.

Rear Terminal

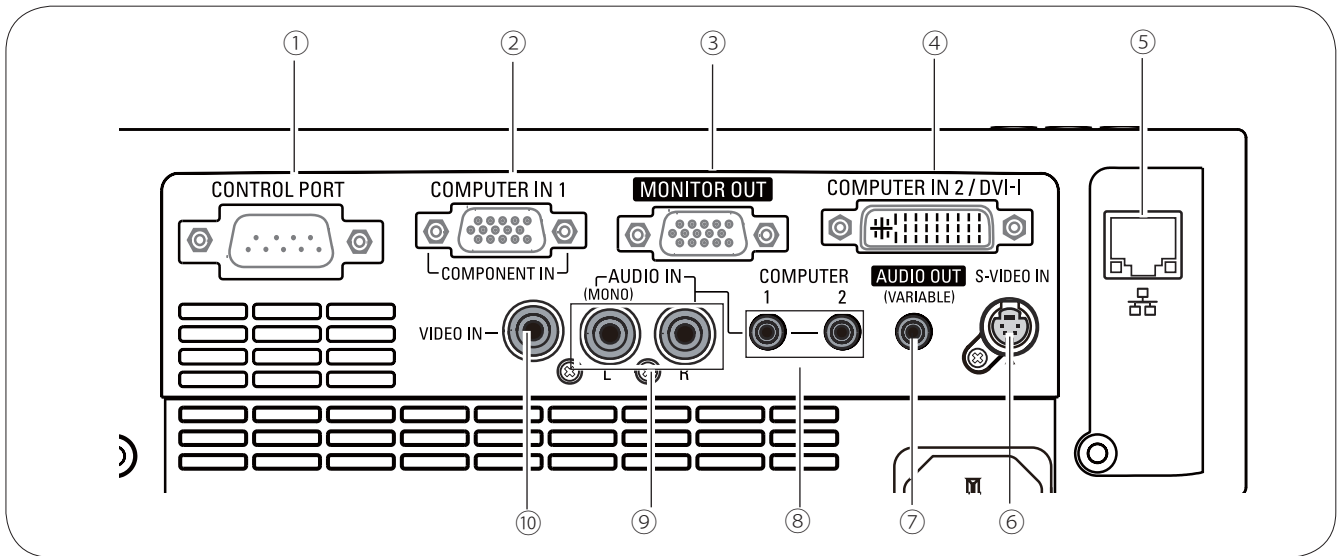

① CONTROL PORT

When the projector is controlled by a computer, connect to this jack with serial control cable.

② COMPUTER IN 1 / COMPONENT IN

Connect output signal from a computer, RGB scart 21-pin video output or component video output to this terminal (pp.14, 16).

③ MONITOR OUT

This terminal can be used to output the incoming analog RGB signal and component signal from COMPUTER IN 1/COMPONENT IN terminal or COMPUTER IN 2/DVI-I terminal to the other monitor (pp.14,16).

④ COMPUTER IN 2 / DVI-I

Connect computer output (Digital/Analog DVI-I type) to this terminal (pp.14, 16).

⑤ LAN Connection Terminal

Connect the LAN cable (refer to the owner's manual "Network Set-up and Operation").

⑥ S-VIDEO IN

Connect the S-VIDEO output signal from video equipment to this jack (p.16).

⑦ AUDIO OUT (VARIABLE)

Connect an external audio amplifier to this jack (pp.14-16).

This terminal outputs sound from AUDIO IN terminal (⑧ or ⑨).

Never plug headphones and earphones into this jack.

⑧ COMPUTER 1 / COMPUTER 2 AUDIO IN

Connect the audio output (stereo) from a computer or video equipment connected to ② or ④ to this jack. (pp14, 16)

⑨ AUDIO IN

Connect the audio output signal from video equipment connected to ⑥ or ⑩ to this jack.

For a mono audio signal (a single audio jack), connect it to the L (MONO) jack (p.15).

⑩ VIDEO IN

Connect the composite video output signal to this jack (p.15).

Top Control

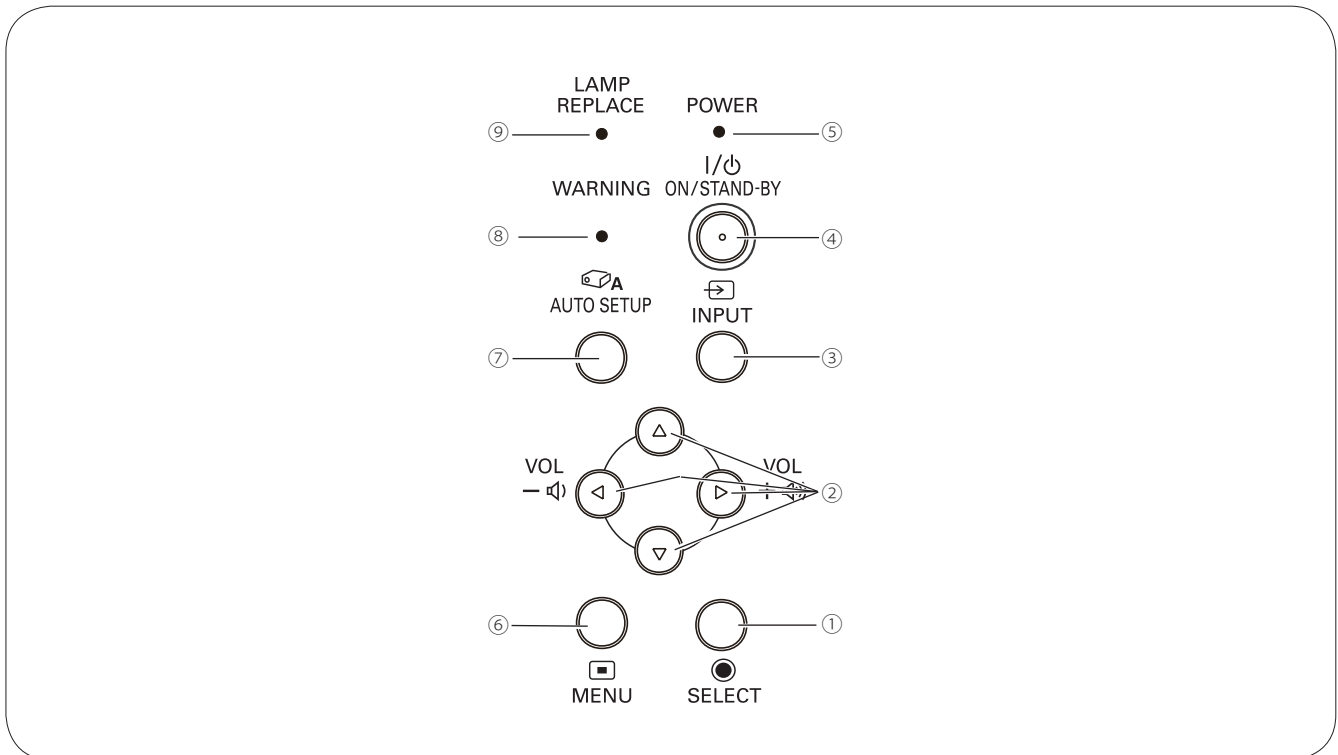

① SELECT button

- Execute the selected item (p.21).
- Expand or compress the image in the Digital zoom mode (p.36).

② POINT ▲ ▼ ◀ ▶ (VOLUME +/-) buttons

- Select an item or adjust the value in the On-Screen Menu (p.21).
- Pan the image in the Digital zoom +/- mode (p.36).
- Adjust the volume level (Point ◀ ▶ buttons) (p.24).

③ INPUT button

Select an input source (pp.27-28, 37-38).

④ ON/STAND-BY button

Turn the projector on or off (pp.18-20).

⑤ POWER indicator

- Lights red when the projector is in stand-by mode.
- Lights green during operations.
- Blinks green in the Power management mode (p.51).

⑥ MENU button

Open or close the On-Screen Menu (p.21).

⑦ AUTO SETUP button

Execute the setting of Auto setup (includes Input search, Auto PC adj. and Auto Keystone functions) in the setting menu. (pp.23, 45).

⑧ WARNING indicator

- Lights red when the projector detects an abnormal condition.
- Blinks red when the internal temperature of the projector exceeds the operating range (pp.59, 70).

⑨ LAMP REPLACE indicator

Lights yellow when the projection lamp reaches its end of life (pp.62, 70).

Remote Control

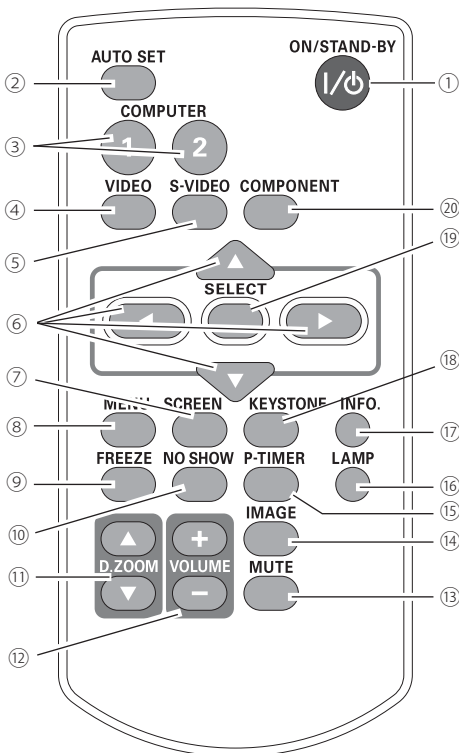

- ① **ON/STAND-BY button**
Turn the projector on or off. (pp.18-20)
- ② **AUTO SET button**
Execute the setting of Auto setup (includes Input search, Auto PC adj. and Auto Keystone functions) in the setting menu. (pp.23, 45)
- ③ **COMPUTER 1/2 buttons**
Select the COMPUTER 1 or COMPUTER 2 input source. (pp.27-28, 38)
- ④ **VIDEO button**
Select the VIDEO input source. (p.37)
- ⑤ **S-VIDEO button**
Select the S-VIDEO input source. (p.37)
- ⑥ **Point ▲▼◀▶ buttons**
– Select an item or adjust the value in the On-Screen Menu. (p.21)
– Pan the image in the Digital zoom +/- mode. (p.36)
- ⑦ **SCREEN button**
Select a screen mode. (pp.26, 35-36, 43)
- ⑧ **MENU button**
Open or close the On-Screen Menu. (p.21)
- ⑨ **FREEZE button**
Freeze the picture on the screen. (p.25)
- ⑩ **NO SHOW button**
Temporarily turn off the image on the screen. (p.26)
- ⑪ **D.ZOOM ▲▼ buttons**
Zoom in and out the images. (pp.25, 36)
- ⑫ **VOLUME +/- buttons**
Adjust the volume level. (p.24)
- ⑬ **MUTE button**
Mute the sound. (p.24)
- ⑭ **IMAGE button**
Select the image mode. (pp.26, 33, 40)
- ⑮ **P-TIMER button**
Operate the P-timer function. (p.26)
- ⑯ **LAMP button**
Select a lamp mode. (pp.25, 53)
- ⑰ **INFO. button**
Operate the information function. (p.58)
- ⑱ **KEYSTONE button**
Correct keystone distortion. (pp.23, 46)
- ⑲ **SELECT button**
– Execute the selected item. (p.21)
– Expand or compress the image in Digital zoom mode. (p.36)
- ⑳ **COMPONENT button**
Select the COMPONENT input source. (p.38)

✓ **Note:**

- To ensure safe operation, please observe the following precautions:
- Do not bend, drop, or expose the remote control to moisture or heat.
 - For cleaning, use a soft dry cloth. Do not apply benzene, thinner, spray, or any chemical material.

Part Names and Functions

Remote Control Battery Installation

- 1** Open the battery compartment lid.

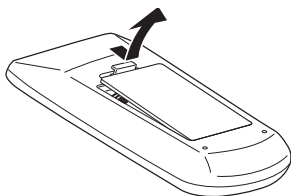

- 2** Install new batteries into the compartment.

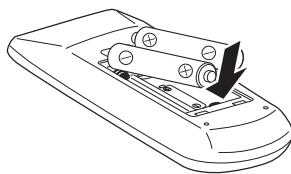

- 3** Replace the compartment lid.

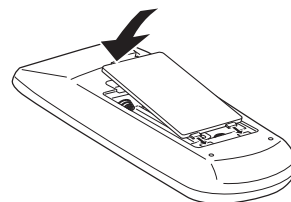

Two AAA size batteries

For correct polarity (+ and -), be sure battery terminals are in contact with pins in compartment.



To ensure safe operation, please observe the following precautions :

- Use two (2) AAA or LR03 type alkaline batteries.
- Always replace batteries in sets.
- Do not use a new battery with a used battery.
- Avoid contact with water or liquid.
- Do not expose the remote control to moisture or heat.
- Do not drop the remote control.
- If the battery has leaked on the remote control, carefully wipe the case clean and install new batteries.
- Risk of an explosion if battery is replaced by an incorrect type.
- Dispose of used batteries according to the instructions or your local disposal rule or guidelines.

Remote Control Operating Range

Point the remote control toward the projector (Infrared Remote Receiver) when pressing the buttons. Maximum operating range for the remote control is about 16.4'(5 m) and 60 degrees in front of the projector.

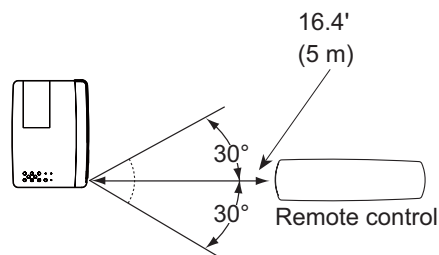

Remote Control Code

The 2 different remote control codes (Code 1–Code 2) are assigned to this projector. Switching the remote control codes prevents interference from other remote controls when several projectors or video equipment next to each other are operated at the same time. Change the remote control code for the projector first before changing that for the remote control. See "Remote control" in the Setting Menu on page 53.

Press and hold the MENU and IMAGE buttons for more than five seconds to switch between the **Code 1** and **Code 2**. The initial code is set to **Code 1**.

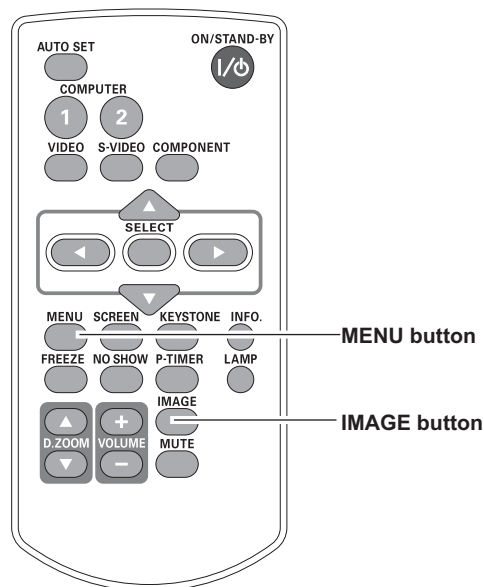

Installation

Positioning the Projector

For projector positioning, see the figures below. The projector should be set perpendicularly to the plane of the screen.

✓ **Note:**

- The brightness in the room has a great influence on picture quality. It is recommended to limit ambient lighting in order to obtain the best image.
- All measurements are approximate and may vary from the actual sizes.

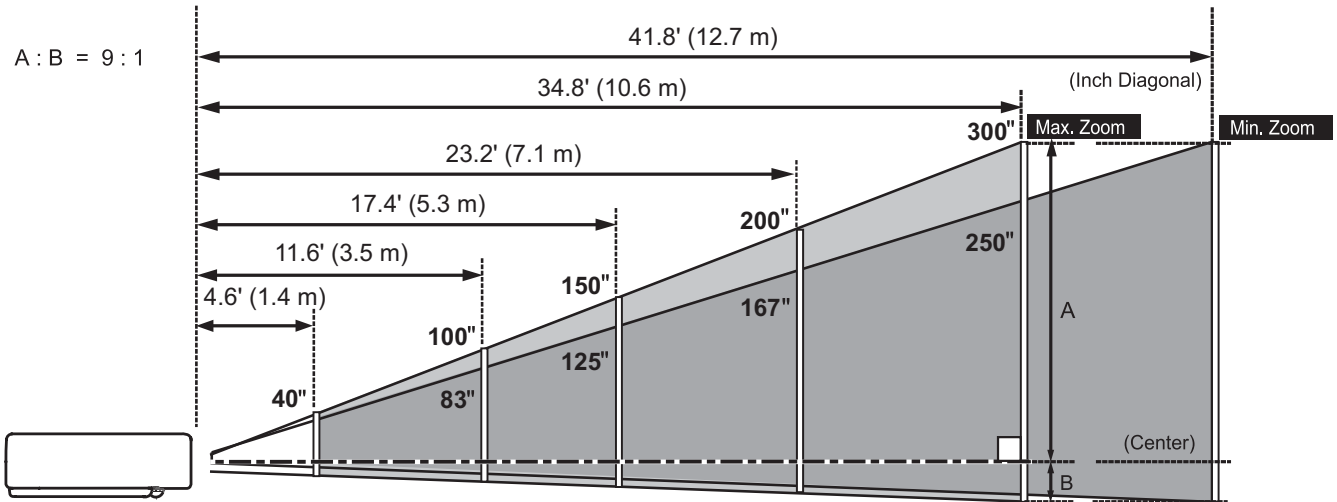

Screen Size (W x H) mm 4 : 3 aspect ratio	40"	100"	150"	200"	300"
Zoom (max)	4.6' (1.4 m)	11.6' (3.5 m)	17.4' (5.3 m)	23.2' (7.1 m)	34.8' (10.6 m)
Zoom (min)	5.5' (1.7 m)	13.9' (4.2 m)	20.9' (6.4 m)	27.8' (8.5 m)	41.8' (12.7 m)

Adjustable Feet

Projection angle can be adjusted up to 12.0 degrees with the adjustable feet.

Lift the front of the projector and press the feet lock latches on both side of the projector.

Release the feet lock latches to lock the adjustable feet and rotate the adjustable feet to a proper height and tilt.

Keystone distortion can be adjusted automatically with the Auto setup function or manually by using the remote control or the menu operation (see pages23, 45-46).

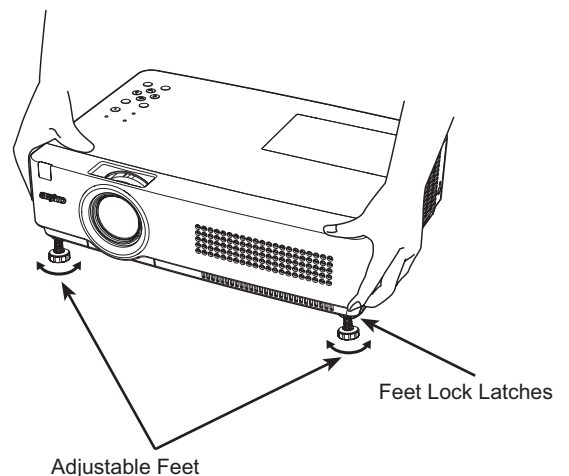

Connecting to a Computer

Cables used for connection

- VGA Cable (Mini D-sub 15 pin) *
- DVI-VGA Cable
- DVI Cable
- Audio Cables

(*One cable is supplied; other cables are not supplied with the projector.)

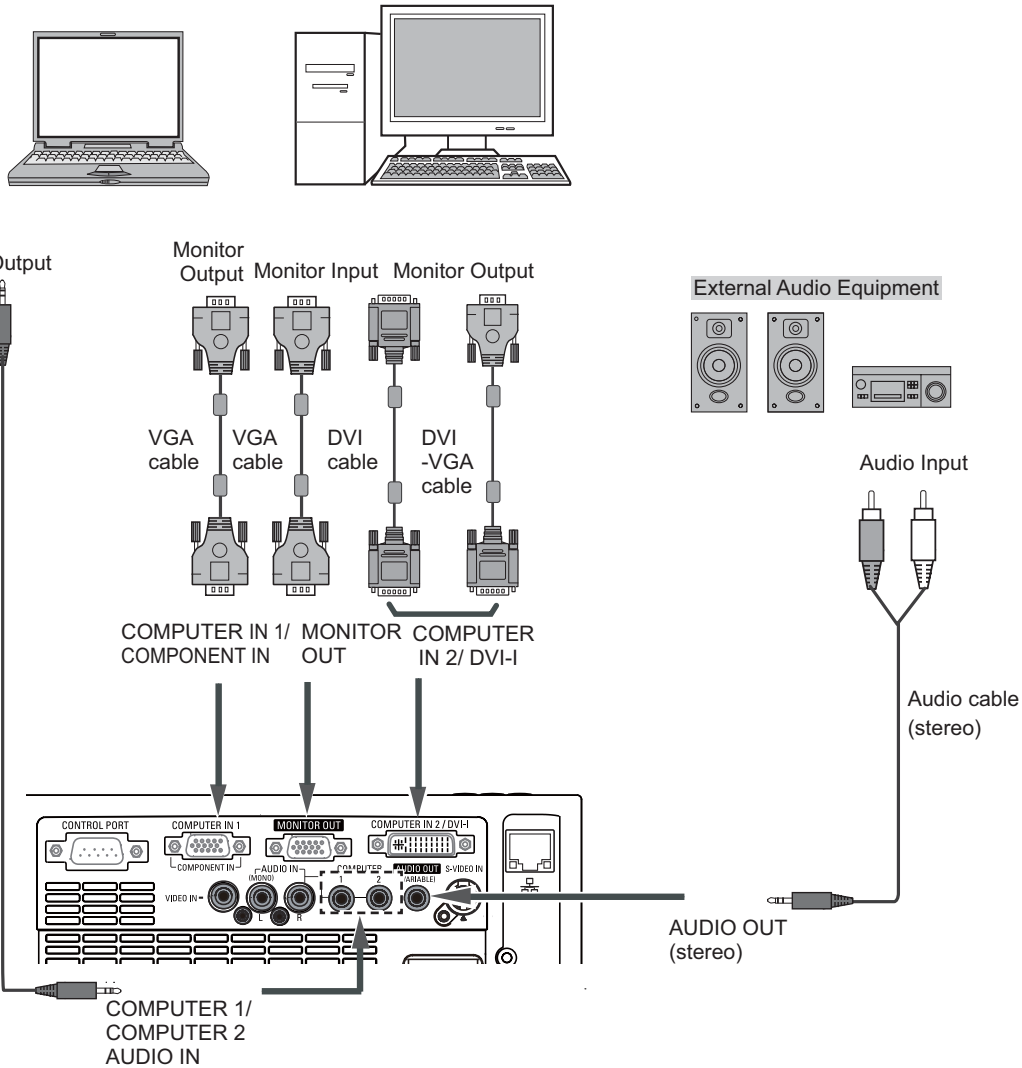

✓ Note:

- Input sound to the COMPUTER1 /COMPUTER 2 AUDIO IN terminals when using the COMPUTER IN 1/ COMPONENT IN and the COMPUTER IN 2/DVI-I terminals as input.
- When the AUDIO OUT is plugged-in, the projector's built-in speaker is not available.
- When input **RGB(PC digital)** source to the MONITOR OUT terminal, the MONITOR OUT terminal is not available.



Unplug the power cords of both the projector and external equipment from the AC outlet before connecting cables.

Connecting to Video Equipment

Cables used for connection

- Video and Audio Cable (RCA x 3)
 - S-Video Cable
 - Audio Cable
- (Cables are not supplied with the projector.)

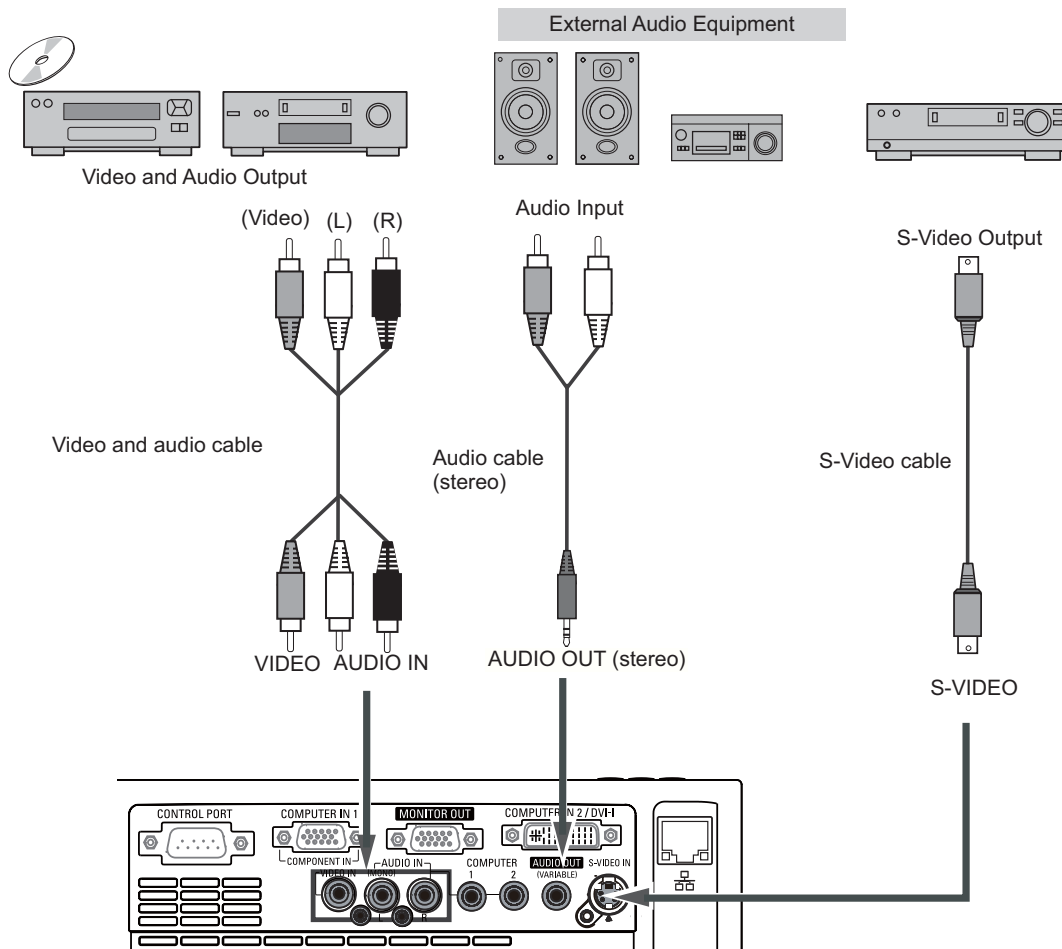

✓ **Note:**
When the AUDIO OUT is plugged-in, the projector's built-in speaker is not available.

 Unplug the power cords of both the projector and external equipment from the AC outlet before connecting cables.

Connecting to Component Video and RGB (Scart) Equipment

Cables used for connection

- Audio Cables
 - Scart-VGA Cable
 - VGA Cable
 - Component Cable
 - Component-VGA Cable
- (Cables are not supplied with this projector.)

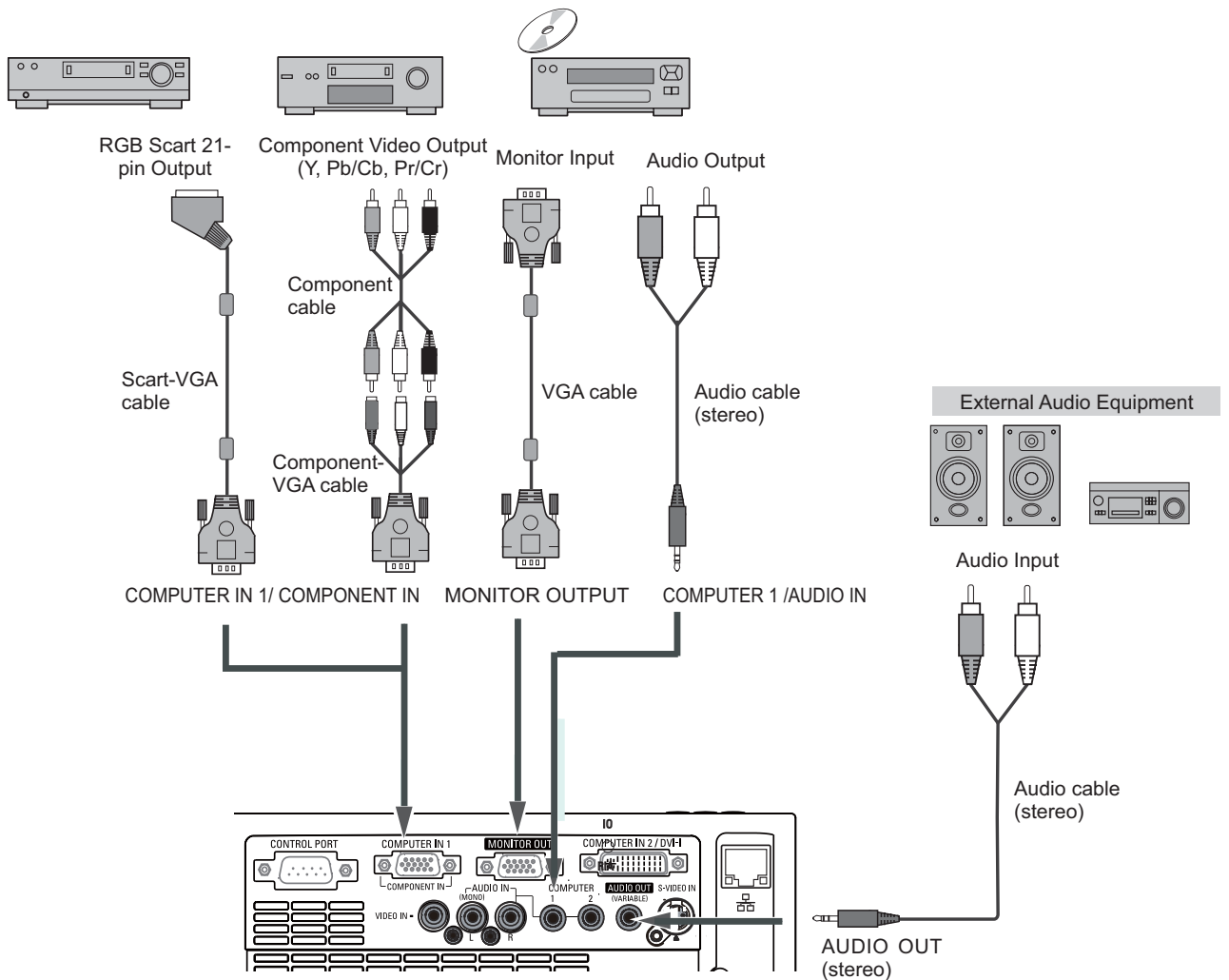

✓ Note:

- When the AUDIO OUT is plugged-in, the projector's built-in speaker is not available.
- See page 74 for ordering optional cables.



Unplug the power cords of both the projector and external equipment from the AC outlet before connecting cables.

Connecting the AC Power Cord

This projector uses nominal input voltages of 100-120 V or 200–240 V AC and it automatically selects the correct input voltage. It is designed to work with single-phase power systems having a grounded neutral conductor. To reduce the risk of electrical shock, do not plug into any other type of power system.

If you are not sure of the type of power being supplied, consult your authorized dealer or service station.

Connect the projector with all peripheral equipment before turning the projector on.

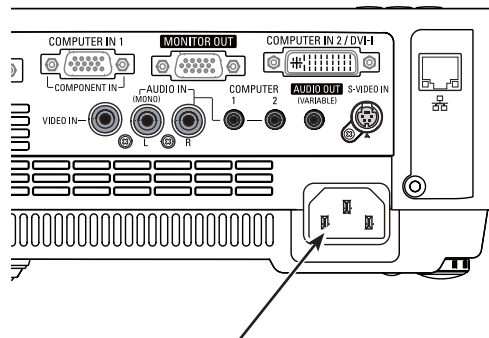

Connect the AC power cord (supplied) to the projector.



CAUTION

The AC outlet must be near this equipment and must be easily accessible.

✓ **Note:**

Unplug the AC power cord when the projector is not in use. When this projector is connected to an outlet with the AC power cord, it is in Stand-by mode and consumes a little electric power.

NOTE ON THE POWER CORD

AC power cord must meet requirement of the country where you use the projector. Confirm the AC plug type with the chart below and proper AC power cord must be used. If supplied AC power cord does not match your AC outlet, contact your sales dealer.

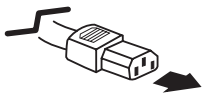
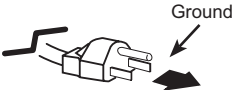
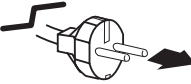
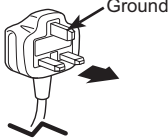
Projector side	AC outlet side		
 <p>To power cord connector on your projector.</p>	<p>For the U.S.A. and Canada</p>  <p>To the AC outlet. (120 V AC)</p>	<p>For Continental Europe</p>  <p>To the AC outlet. (200 - 240 V AC)</p>	<p>For the U.K.</p>  <p>To the AC outlet. (200 - 240 V AC)</p>

Basic Operation

Turning On the Projector

- 1 Complete peripheral connections (with a computer, VCR, etc.) before turning on the projector.
- 2 Connect the projector's AC power cord into an AC outlet. The POWER indicator lights red. Open the lens cap (see pages 8, 61).
- 3 Press the ON/STAND-BY button on the top control or on the remote control. The POWER indicator lights green and the cooling fans start to operate. The preparation display appears on the screen and the countdown starts.
- 4 After the countdown, the input source that was selected the last time and the lamp control status icon (see page 53) appear on the screen.
- 5 If there is no signal input when start on the projector, or the current signal is missed while operating the projector, the Video/PC selection window will be displayed on the screen, please move the pointer to input source desired by pressing the Point ▲▼ buttons and press the SELECT button. And then follow the input signal guidance window to correct the signal and connection.

If the projector is locked with a PIN code, PIN code input dialog box will appear. Enter the PIN code as instructed on the next page.

✓ **Note:**

- When the Logo select function is set to **Off**, the logo will not be shown on the screen (p.47).
- When **Countdown off** or **Off** is selected in the Display function, the countdown will not be shown on the screen (p.46).
- When the Input Search function is set to **On2**, the input signal will be searched automatically (p.45).
- When **Off** is selected in the Display function, the Video/PC selection window and the input signal guidance window are not shown on the screen. (p.46)



The preparation display will disappear after 30 seconds.

Selected Input Source and Lamp Control



(See page 53 for Lamp control status.)

✓ **Note:**

The Filter warning and Lamp replacement icons may appear on the screen depending on the usage state of the projector.

Video Selection

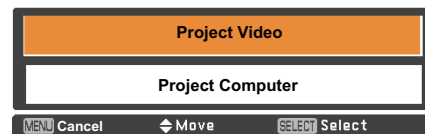

Guidance for Video Input

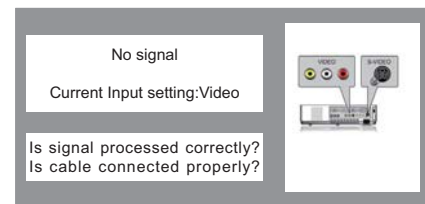

PC Selection

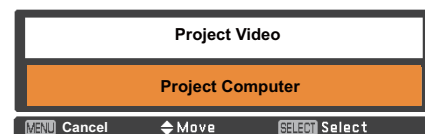

Guidance for PC Input

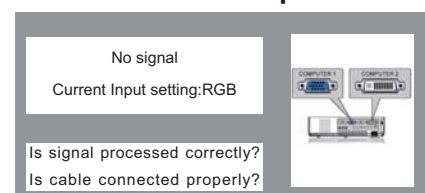

Enter a PIN code

Use the Point ▲▼ buttons to enter a number. Press the Point ► button to fix the number and move the red frame pointer to the next box. The number changes to “*”. If you fixed an incorrect number, use the Point ◀ button to move the pointer to the number you want to correct, and then enter the correct number.

Repeat this step to complete entering a four-digit number.

After entering the four-digit number, move the pointer to **Set**. Press the SELECT button so that you can start to operate the projector.

If you entered an incorrect PIN code, **PIN code** and the number (****) will turn red for a moment. Enter the correct PIN code all over again.

What is PIN code?

PIN (Personal Identification Number) code is a security code that allows the person who knows it to operate the projector. Setting a PIN code prevents unauthorized use of the projector.

A PIN code consists of a four-digit number. Refer to the PIN code lock function in the Setting Menu on pages 54-55 for locking operation of the projector with your PIN code.

✓Note:

- If the PIN code number is not entered within three minutes after the PIN code dialog box appeared, the projector will be turned off automatically.
- The “1234” is set as the initial PIN code at the factory.

PIN Code Input Dialog Box

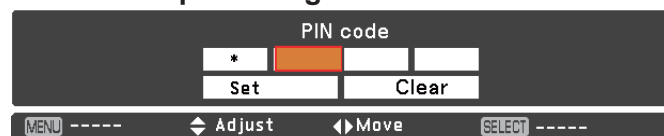

After the OK icon disappears, you can operate the projector.



CAUTION ON HANDLING PIN CODE

If you forget your PIN code, the projector can no longer be started. Take a special care in setting a new PIN code; write down the number in a column on page 77 of this manual and keep it on hand. Should the PIN code be missing or forgotten, consult your dealer or service center.

Turning Off the Projector

- 1 Press the ON/STAND-BY button on the top control or on the remote control, and **Power off?** appears on the screen.
- 2 Press the ON/STAND-BY button again to turn off the projector. The POWER indicator starts to blink red, and the cooling fans keep running. (You can select the level of fans' quietness and speed. See "Fan" on page 56.) At this time, you can unplug the AC power cord even if the fans are still running.
- 3 When the projector has cooled down enough, the POWER indicator stops blinking and you can turn on the projector.



TO MAINTAIN THE LIFE OF THE LAMP, ONCE YOU TURN THE PROJECTOR ON, WAIT AT LEAST FIVE MINUTES BEFORE TURNING IT OFF.



DO NOT OPERATE THE PROJECTOR CONTINUOUSLY WITHOUT REST. CONTINUOUS USE MAY RESULT IN SHORTENING THE LAMP LIFE. TURN OFF THE PROJECTOR AND LET IT STAND FOR ABOUT AN HOUR IN EVERY 24 HOURS.

✓ **Note:**

- When the Direct on function is set to **On**, the projector will be turned on automatically by connecting the AC power cord to an AC outlet (p.52).
- The running speed of cooling fans is changed according to the temperature inside the projector.
- Do not put the projector in a case before the projector is cooled enough.
- If the WARNING indicator blinks or lights red, see "WARNING indicator" on page 59.
- While the POWER indicator is blinking, the lamp is being cooled down and the projector cannot be turned on. Wait until the POWER indicator stops blinking to turn on the projector again.
- The fan rotation will terminate directly if the AC power cord is unplugged immediately after the projector is turned off.
- The projector can be turned on after the POWER indicator turns red. The waiting time to restart will be shortened when the normal power-off processing for fan cooling is completed, compared with the time the AC power cord is immediately unplugged after the power-off.

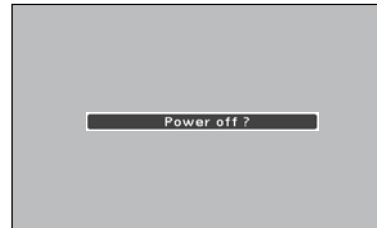

Power off? disappears after 4 seconds.

Direct Off Function

You can disconnect the power cord from the wall outlet or turn off the breaker even during projection without pressing the ON/STAND-BY button.

✓ **Note:**

When using the Direct Off function, you can not restart the projector immediately after the power is disconnected. If the external power supply is suddenly cut off, the fans stop immediately. The lamp remains high temperature and needs to be cooled.

How to Operate the On-Screen Menu

The projector can be adjusted or set via the On-Screen Menu. The menus have a hierarchical structure, with a main menu that is divided into submenus, which are further divided into other submenus. For each adjustment and setting procedure, refer to respective sections in this manual.

- 1 Press the MENU button on the top control or the remote control to display the On-Screen Menu.
- 2 Use the Point ▲▼ buttons to highlight or select a main menu item. Press the Point ► or the SELECT button to access the submenu items. (The selected item is highlighted in orange.)
- 3 Use the Point ▲▼ buttons to select the desired submenu item and press the SELECT button to set or access the selected item.
- 4 Use the Point ▲▼◀▶ buttons to adjust the setting or switch between each option and press the SELECT button to activate it and return to the submenu.
- 5 Press the Point ◀ button to return to the main menu. Press the MENU button to exit the On-Screen Menu.

Top Control

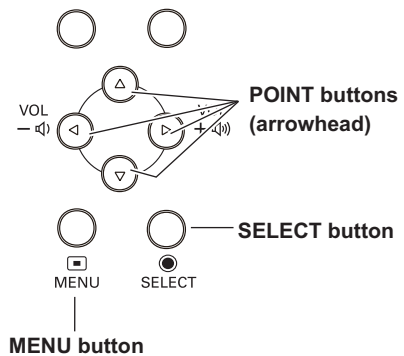

Remote Control

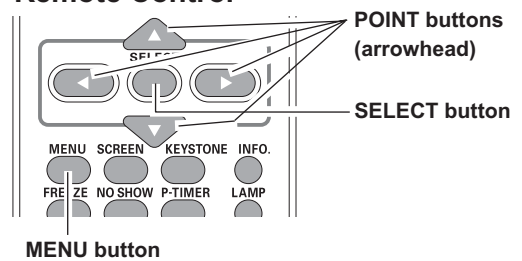

On-Screen Menu

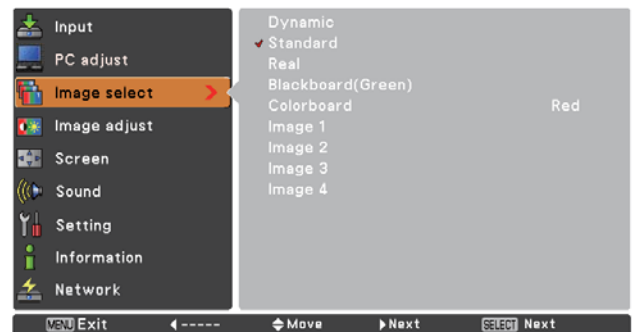

The currently set item is check marked.

The selected item is highlighted in orange.

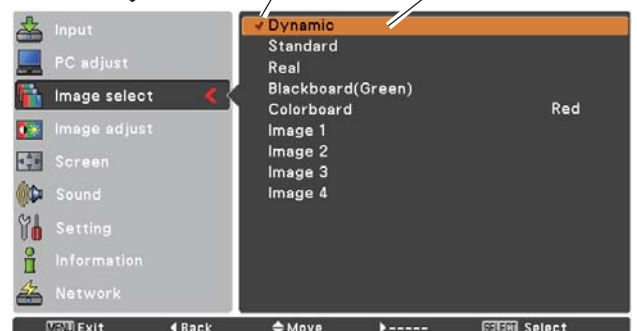

Basic Operation

Menu Bar

For detailed functions of each menu, see “Menu Tree” on pages 68-69.



- ① **Input**
Used to select an input source from **Computer 1**, **Computer 2**, **Video** or **S-video**. (pp.27-28,37-38).
- ② **PC adjust**
Select **Auto PC adj.**, **Fine sync**, **Total dots**, **Horizontal**, **Vertical**, **Clamp**, **Display area-H** and **Display area-V** to adjust the parameters to match with the PC input signal format (pp.30-32).
- ③ **Image select**
For computer source, used to select an image mode from among **Dynamic**, **Standard**, **Real**, **Blackboard(Green)**, **Colorboard** and **image 1 - 4** (p.33).
For Video source, used to select an image mode among **Dynamic**, **Standard**, **Cinema**, **Blackboard(Green)**, **Colorboard** and **Image 1- 4** (p.40).
- ④ **Image adjust**
For computer source, used to adjust computer image [**Contrast**, **Brightness**, **Color temp.**, **White balance (R/G/B)**, **Sharpness** and **Gamma**] (pp.34-35).
For Video source, used to adjust picture image [**Contrast**, **Brightness**, **Color**, **Tint**, **Color temp.**, **White balance (R/G/B)**, **Sharpness**, **Gamma**, **Noise reduction** and **Progressive**] (pp.41-42).
- ⑤ **Screen**
For computer source, used to adjust size of the image [**Normal**, **True**, **Wide**, **Full**, **Custom** and **Digital zoom +/-**] (pp.35-36).
For Video source, used to set size of image [**Normal**, **Wide** and **Custom**] (p.43).
- ⑥ **Sound**
Used to adjust the volume or mute the sound (p.24).
- ⑦ **Setting**
Used to set the projector’s operating configurations (pp.44-57).
- ⑧ **Information**
Display the input source information: **Input**, **H-sync freq.**, **V-sync freq.**, **Screen**, **Language**, **Lamp status**, **Lamp counter**, **Power management**, **Key lock**, **PIN code lock** and **Remote control** (p.58).
- ⑨ **Network**
See the owner’s manual of “Network Set-up and Operation”.
- ⑩ **Guide**
The key operation is displayed.

Zoom and Focus Adjustment

Rotate the Zoom Ring to zoom in and out.
 Rotate the Focus Ring to adjust the focus of the image.

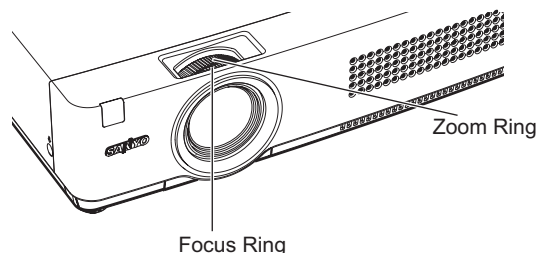

Auto Setup Function

Auto setup function is provided to automatically execute the setting of Auto setup (includes Input search, Auto PC adj. and Auto Keystone functions) in the setting menu by just pressing the AUTO SETUP button on the top control or the AUTO SET button on the remote control. Refer to page 45 for the setting of the Auto setup function.

Notes:

- Auto Keystone corrects vertical distortion only; it does not correct horizontal distortion.
- Auto Keystone cannot work when Ceiling feature is set to **On** in the Setting menu (p.50).
- Perfect correction of the image distortion cannot be ensured with the Auto setup function. If the distortion cannot be corrected properly by pressing the AUTO SETUP or AUTO SET button, adjust manually by pressing the KEYSTONE button on the remote control or selecting Keystone in the Setting menu (p.46).
- **Fine sync, Total dots, Horizontal and Vertical** position of some computers cannot be fully adjusted with the Auto PC Adjustment function. When the image is not provided properly with this operation, manual adjustments are required (pp.31-32).

Top Control

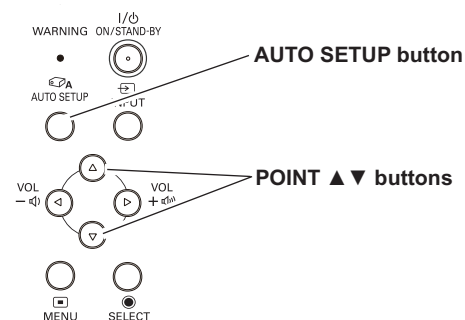

Remote Control

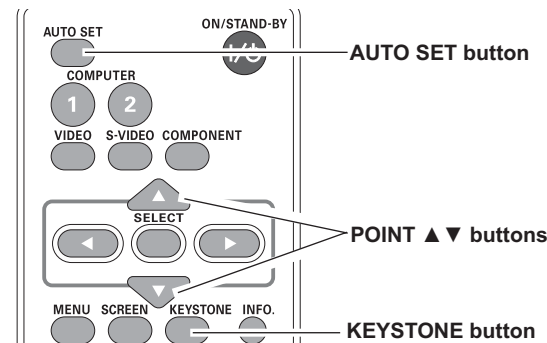

Keystone Correction

If a projected picture still has keystone distortion after pressing the AUTO SETUP button on the top control or the AUTO SET button on the remote control, correct the image manually as follows:

Press the KEYSTONE button on the remote control. The Keystone dialog box appears. Use the Point ▲▼ buttons to correct keystone distortion. The keystone adjustment can be stored (see page 46).

Reduce the upper width with the Point ▲ button.

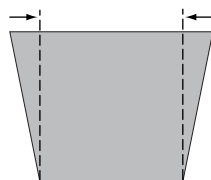

Reduce the lower width with the Point ▼ button.

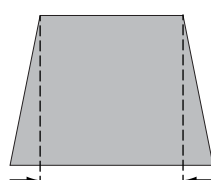

- The white arrows indicate that there is no correction.
- A red arrow indicates the direction of correction.
- An arrow disappears at the maximum correction.
- If you press the KEYSTONE button on the remote control once more while the keystone dialog box is being displayed, the keystone adjustment will be canceled.
- The adjustable range is limited depending on the input signal.

Basic Operation

Sound Adjustment

Direct Operation

Volume

Press the VOLUME+/- buttons on the top control or on the remote control to adjust the volume. The volume dialog box appears on the screen for a few seconds.

Mute

Press the MUTE button on the remote control to select **On** to temporarily turn off the sound. To turn the sound back on, press the MUTE button again to select **Off** or press the VOLUME +/- buttons. The Mute function is also effective for the AUDIO OUT jack.

Menu Operation

- 1 Press the MENU button to display the On-Screen Menu. Use the Point ▲▼ buttons to select **Sound**. Press the Point ► or the SELECT button to access the submenu items.
- 2 Use the Point ▲▼ buttons to select the desired submenu item and press the SELECT button to access the selected item.

Volume

Press the Point ▲ button to turn up the volume; press the Point ▼ button to turn down the volume.

Mute

Press the SELECT button to switch the mute function **On/Off**. When the sound is turned off, **On** is displayed. Press the VOLUME +/- buttons again to turn the sound back on.

Top Control

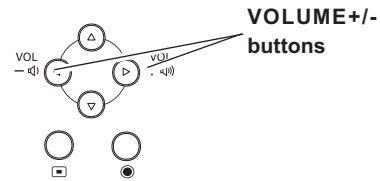

Remote Control

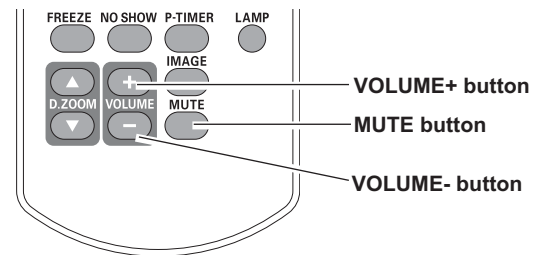

Volume Dialog Box

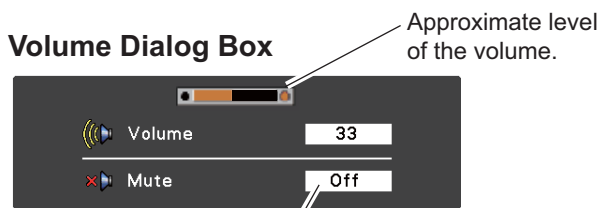

Press the MUTE button to set the Mute function **On** or **Off**. The dialog box disappears after 4 seconds.

Sound Menu

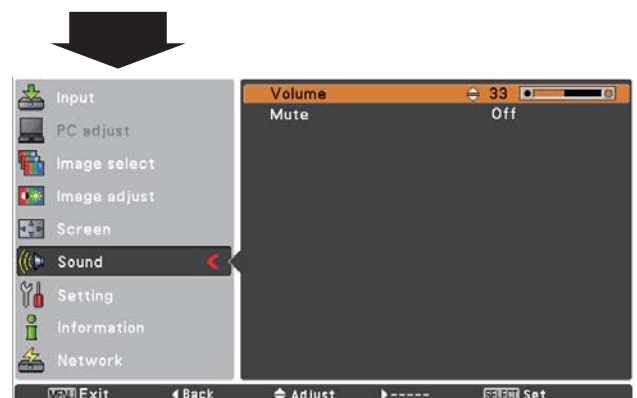
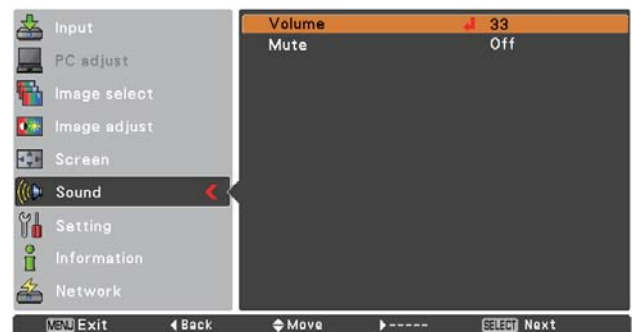

Remote Control Operation

Using the remote control for some frequently used operations is advisable. Just pressing one of the buttons enables you to make the desired operation quickly without calling up the On-Screen Menu.

COMPUTER 1/2, VIDEO, S-VIDEO and COMPONENT buttons

Press the COMPUTER 1/2, VIDEO, S-VIDEO and COMPONENT buttons on the remote control to select the input source. See pages 27-28,37-38 for details.

FREEZE button

Press the FREEZE button on the remote control to freeze the picture on the screen. To cancel the Freeze function, press the FREEZE button again or press any other button.

Fig.1 will appear on the Screen menu while the Freeze function is working.

Fig.1



INFO. button

Display the input source information: **Input, H-sync freq., V-sync freq., Screen, Language, Lamp status, Lamp counter, Power management, Keylock, PIN code lock and Remote control** (p.58).

D.ZOOM buttons

Press the D.ZOOM buttons on the remote control to enter to the Digital zoom +/- mode. See page 36 for details.

LAMP button

Press the LAMP button on the remote control to select the lamp mode for changing the brightness on the screen.

- ☾ Normal..... Normal brightness
- ☾ Eco Lower brightness reduces the lamp power consumption and extends the lamp life.

Remote Control

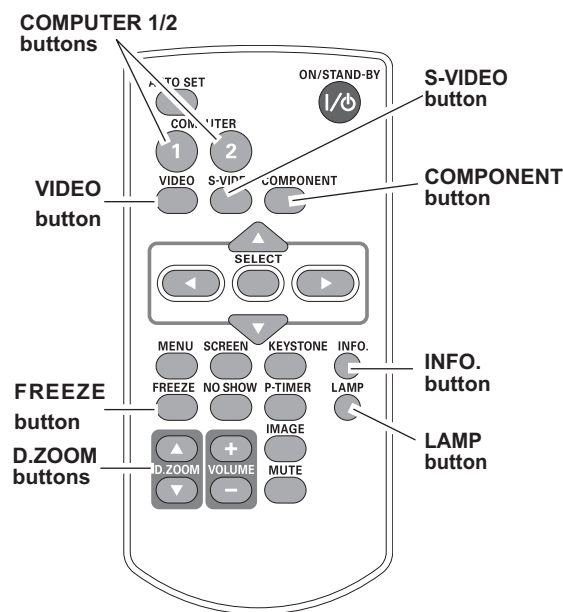

✓ **Note:**

See the next page for the description of other buttons.

Basic Operation

NO SHOW button

Press the NO SHOW button on the remote control to black out the image. To restore to normal, press the NO SHOW button again or press any other button. The screen changes each time you press the NO SHOW button as follows.

black out → normal → black out → normal.....

P-TIMER button

Press the P-TIMER button on the remote control. The P-Timer display **00:00** appears on the screen and the countdown starts (00:00–59:59).

To stop the countdown, press the P-TIMER button. To cancel the P-Timer function, press the P-TIMER button again.

IMAGE button

Press the IMAGE button on the remote control to select a desired image mode of the screen. See pages 33, 40 for details.

SCREEN button

Select the screen size (See pages 35-36, 43 for details).



No show disappears after 4 seconds.

P-timer

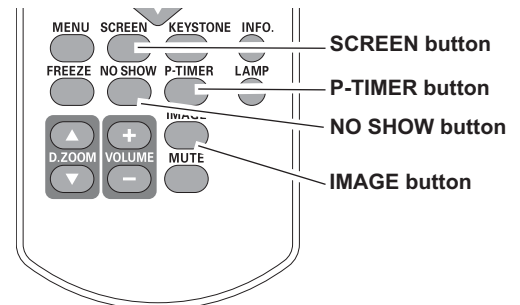

✓ **Note:**

See the previous page for the description of other buttons.

Computer Input

Input Source Selection (RGB: Computer 1/Computer 2 (Analog))

Direct Operation

Choose either **Computer 1 (RGB)** or **Computer 1 (Scart)** or **Computer 2 (Analog)** by pressing the INPUT button on the top control or press the COMPUTER 1 button or Computer 2 on the remote control.

Before using INPUT button, correct input source should be selected through Menu operation as described below.

Remote Control

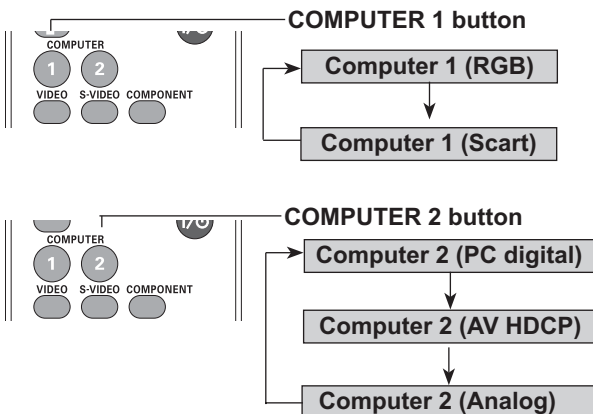

Top Control

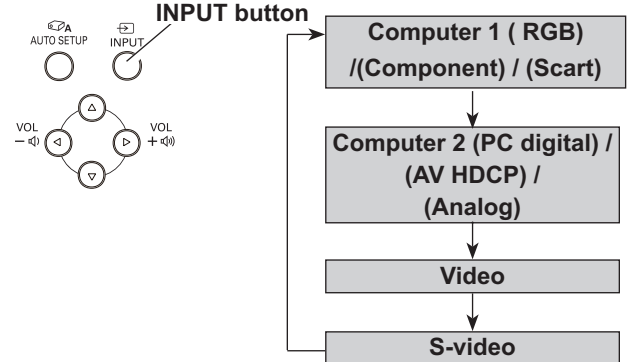

Menu Operation

- 1 Press the MENU button to display the On-Screen Menu. Use the Point ▲▼ buttons to select **Input** and then press the Point ► or the SELECT button.
- 2 Use the Point ▲▼ buttons to select **Computer 1**.
- 3 When **Computer 1** is selected, press the Point ► button to access the submenu items. Use the Point ▲▼ buttons to select the RGB input source and then press the SELECT button.

Input Menu

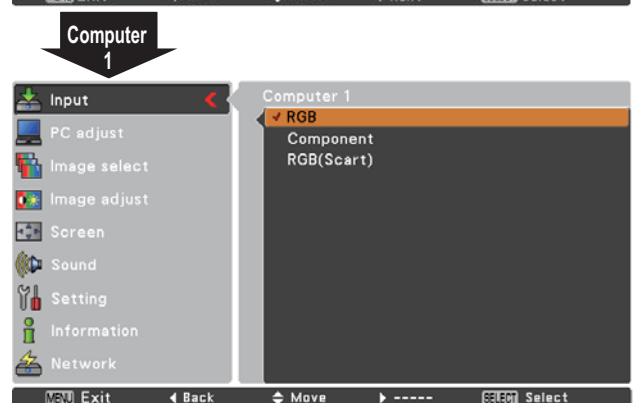
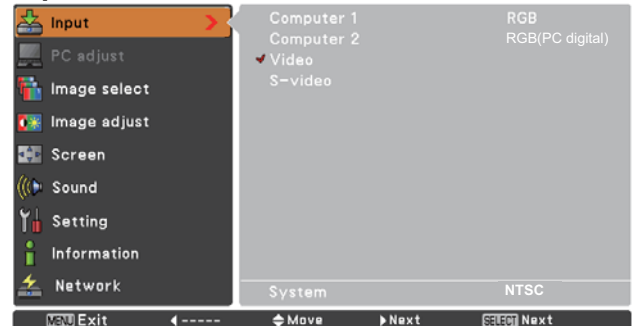

✓ **Note:** When the Input Search function is set to **On1** or **On2** in the Auto setup function, the input signal will be searched automatically (p.45).

Computer Input

Input Source Selection (RGB (PC digital), RGB (AV HDCP))

Direct Operation

Choose **Computer 2 (PC digital)** or **Computer 2 (AV HDCP)** by pressing the INPUT button on the top control or press the COMPUTER 2 button on the remote control.

Before using INPUT button, correct input source should be selected through Menu operation as described below.

Remote Control

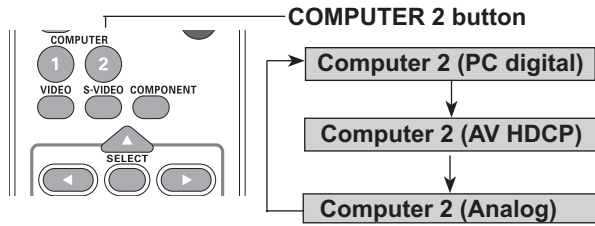

Top Control

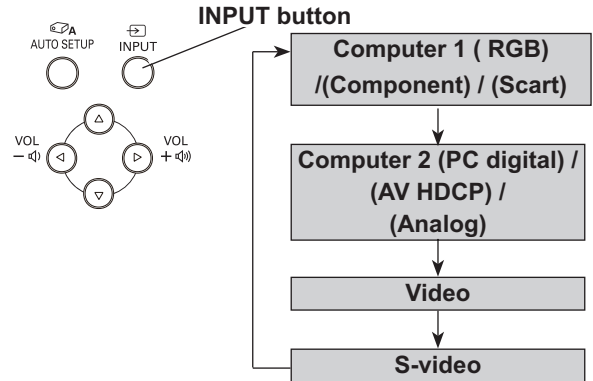

Menu Operation

- 1 Press the MENU button to display the On-Screen Menu. Use the Point ▲▼ buttons to select **Input** and then press the Point ► or the SELECT button.
- 2 Use the Point ▲▼ buttons to select **Computer 2** and then press the Point ► button.
- 3 Use the Point ▲▼ buttons to select **RGB(PC digital)** or **RGB(AV HDCP)** and then press the SELECT button.

Input Menu

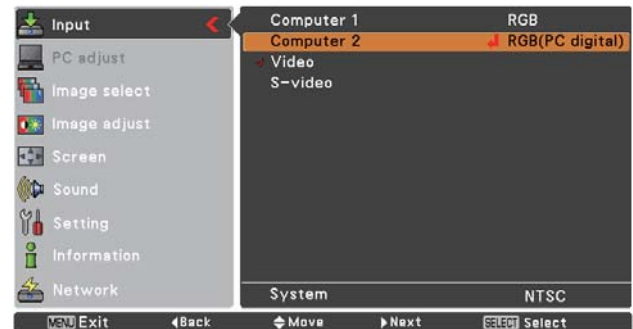

Computer 2



✓Note:

- When the Input Search function is set to **On1** or **On2**, the input signal will be searched automatically (p.45).
- HDCP (High-bandwidth Digital Content Protection) is a system for protecting digital entertainment content delivered by DVI (Digital Visual Interface) from being copied. The specification of HDCP is decided and controlled by Digital Content Protection, LLC. Should the specification be changed, this projector may not display the digital content protected by HDCP.

Computer System Selection

This projector automatically tunes to various types of computers with its Multi-scan system and Auto PC Adjustment. If a computer is selected as a signal source, this projector automatically detects the signal format and tunes to project a proper image without any additional settings. (Signal formats provided in this projector are shown on pages 71-72.)

One of the following messages may appear when:

- Auto** When the projector cannot recognize the connected signal conforming to the provided PC systems, Auto is displayed on the System Menu box and the Auto PC Adjustment function works to display proper images. If the image is not projected properly, a manual adjustment is required (pp.31-32).
- There is no signal input from the computer. Check the connection between your computer and the projector. (See "Troubleshooting" on p.64.)
- Mode 1** The preset system is manually adjusted in the PC adjust Menu. The adjusted data can be stored in **Mode 1–5** (pp.31-32).
- SVGA 1** PC Systems provided in this projector is chosen. The projector chooses a proper system provided in the projector and displays it.

*Mode 1 and SVGA 1 are examples.

PC System Menu

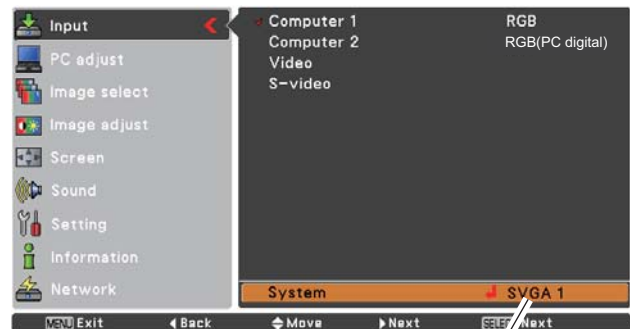

Selected system in the PC System Menu is displayed.

Selecting Computer System Manually

PC system can also be selected manually.

- 1** Press the MENU button to display the On-Screen Menu. Use the Point ▲▼ buttons to select **Input** and then press the Point ► or the SELECT button.
- 2** Use the Point ▲▼ buttons to select **System** and then press the Point ► or the SELECT button.
- 3** Use the Point ▲▼ buttons to select the desired system and then press the SELECT button.

PC System Menu

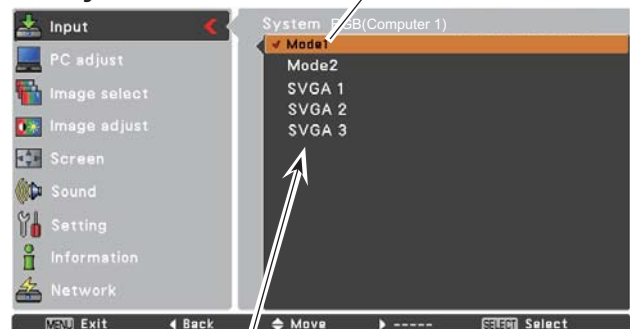

Customized Mode (1–5) set in the PC adjust Menu (pp.31-32).

Systems in this dialog box can be selected.

Computer Input

Auto PC Adjustment

Auto PC Adjustment function is provided to automatically adjust **Fine sync**, **Total dots**, **Horizontal** and **Vertical** positions to conform to your computer.

Menu Operation

Auto PC adj.

- 1 Press the MENU button to display the On-Screen Menu. Use the Point ▲▼ buttons to select **PC adjust** and then press the Point ► or the SELECT button.
- 2 Use the Point ▲▼ buttons to select **Auto PC adj.** and then press the SELECT button.

To store adjustment parameters

The adjusted parameters from the Auto PC Adjustment can be stored in the projector. Once the parameters are stored, the setting can be done just by selecting a **Mode (1–5)** in the PC System Menu (see page 29). See also “Store” on page 32.

✓Note:

- **Fine sync**, **Total dots**, **Horizontal** and **Vertical** position of some computers cannot be fully adjusted with the Auto PC Adjustment function. When the image is not provided properly with this operation, manual adjustments are required (pp.31-32).
- The Auto PC Adjustment cannot be operated when **480i**, **575i**, **480p**, **575p**, **720p**, **1035i** or **1080i** is selected in the PC System Menu (p.29), or when the digital RGB signal is coming from DVI-I terminal.

PC adjust Menu

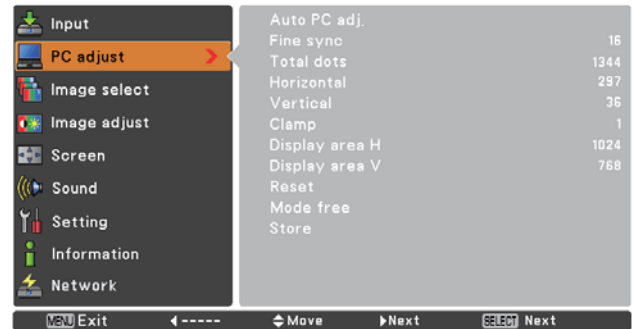

Use Point ▲▼ buttons to select **Auto PC adj.** and press the SELECT button. **Please wait...** appears while the Auto PC adjustment is in process.



Manual PC Adjustment

Some computers employ special signal formats which may not be tuned by Multi-scan system of this projector. Manual PC Adjustment enables you to precisely adjust several parameters to match those signal formats. The projector has 5 independent memory areas to store those parameters manually adjusted. It allows you to recall the setting for a specific computer.

- 1 Press the MENU button to display the On-Screen Menu. Use the Point ▲▼ buttons to select **PC adjust** and then press the Point ► or the SELECT button.
- 2 Use the Point ▲▼ buttons to select the desired item and then press the SELECT button to display the adjustment dialog box. Use the Point ◀▶ buttons to adjust the setting value.

Fine sync

Use the Point ◀▶ buttons to adjust the value, eliminating a flicker from the image displayed (from 0 to 31).

Total dots

Use the Point ◀▶ buttons to adjust the number of total dots in one horizontal period to match your PC image.

Horizontal

Use the Point ◀▶ buttons to adjust the horizontal picture position.

Vertical

Use the Point ◀▶ buttons to adjust the vertical picture position.

Clamp

Use the Point ◀▶ buttons to adjust the clamp level. When the image has dark bars, try this adjustment.

Display area H

Use the Point ◀▶ buttons to adjust the horizontal area displayed by this projector.

Display area V

Use the Point ◀▶ buttons to adjust the vertical area displayed by this projector.

PC adjust Menu

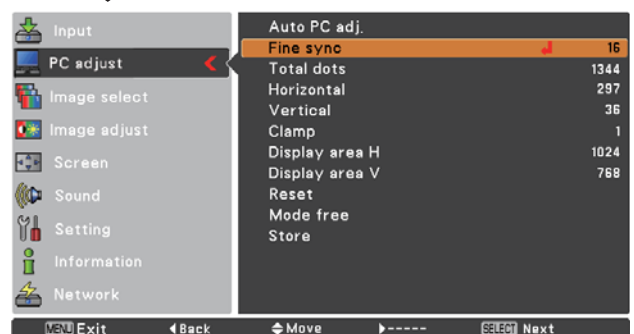
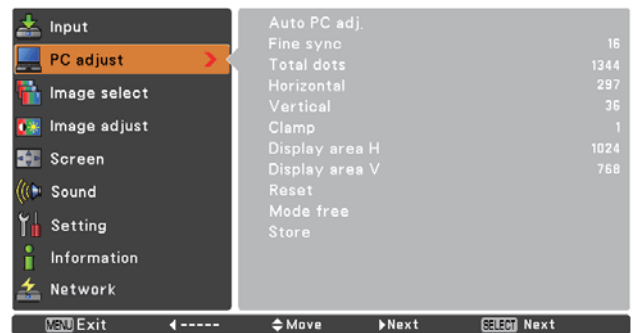

Computer Input

Reset

To reset the adjusted data, select **Reset** and press the SELECT button. A confirmation box appears and then select **Yes**. All adjustments will return to their previous figures.

Mode free

To clear the stored data, select **Mode free** and then press the Point ► or the SELECT button. Move the highlight to the Mode that you want to clear and then press the SELECT button.

Store

To store the adjusted data, select **Store** and then press the Point ► or the SELECT button. Move the highlight to one of the Modes 1 to 5 in which you want to store, and then press the SELECT button.

Mode free

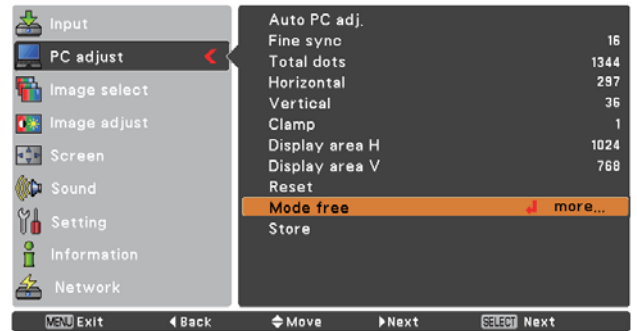

This Mode has stored parameters.

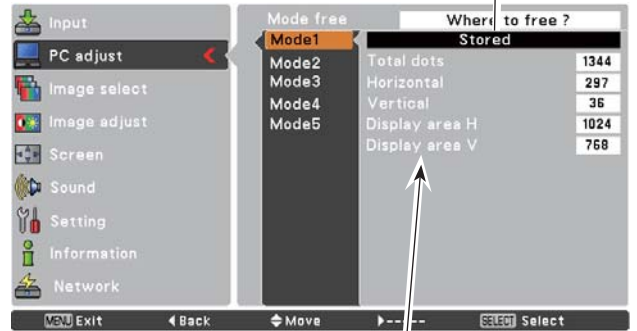

Values of **Total dots**, **Horizontal**, **Vertical**, **Display area H**, and **Display area V**.

Store

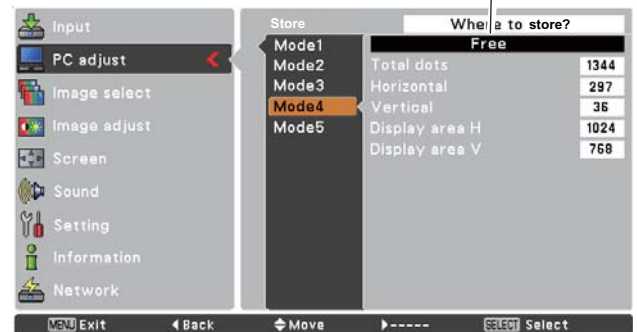

Press MENU button to close this dialog box.

Press SELECT button to store the stored data.

✓ Note:

- **Display area (H/V)** cannot be selected when **480i**, **575i**, **480p**, **575p**, **720p**, **1035i** or **1080i** is selected in the PC System Menu (p.29).
- PC adjust Menu cannot be selected when **Computer 2(PC digital)** and **Computer 2(AV HDCP)** are selected in the Input Menu (p.28).
- When input computer signal to the projector, **PC adjust** will become available.

Image Mode Selection

Direct Operation

Select the desired image mode among **Dynamic**, **Standard**, **Real**, **Blackboard (Green)**, **Colorboard**, **Image 1**, **Image 2**, **Image 3** and **Image 4** by pressing the IMAGE button on the remote control.

Remote Control

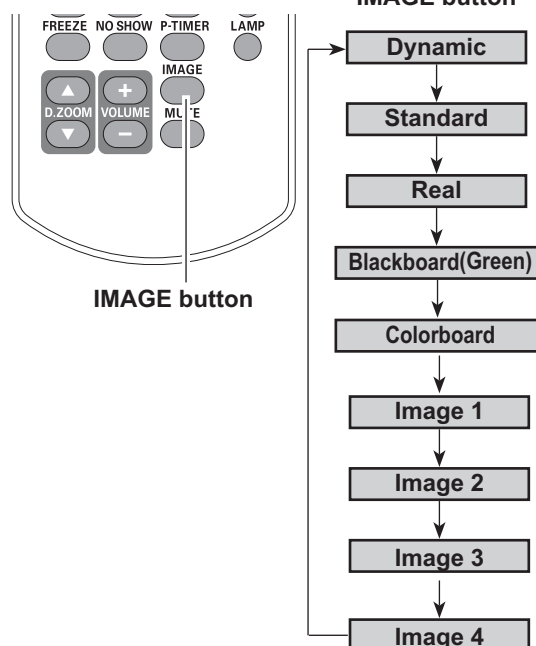

Menu Operation

- 1 Press the MENU button to display the On-Screen Menu. Use the Point ▲▼ buttons to select **Image select** and then press the Point ► or the SELECT button.
- 2 Use the Point ▲▼ buttons to select the desired item and then press the SELECT button.

Dynamic

For viewing pictures in a bright room.

Standard

Normal picture mode preset on the projector.

Real

Picture mode with improved halftone for graphics.

Blackboard (Green)

For the image projected on a blackboard. This mode helps enhance the image projected on a blackboard. This is mainly effective on a green colored board, not truly effective on a black colored board.

Colorboard

At the time of simple projection on the colored wall, you can get the close color image to the color image projected on a white screen by selecting the similar color to the wall color from the preset four colors.

Image 1–4

For viewing with the user preset image mode in the Image Adjust Menu (see pages 34-35). This Image memory is provided in each computer, component, S-video and video input source.

Image select Menu

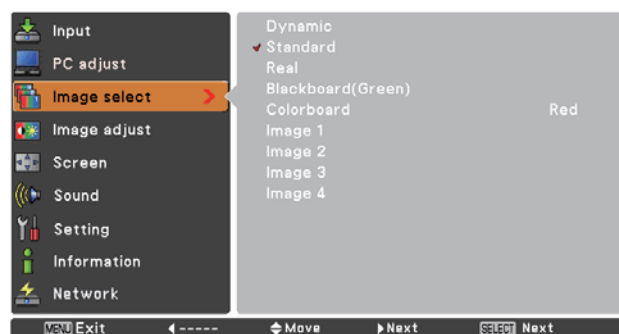

Image Adjustment

- 1 Press the MENU button to display the On-Screen Menu. Use the Point ▲▼ buttons to select **Image adjust** and then press the Point ► or the SELECT button.
- 2 Use the Point ▲▼ buttons select the desired item and then press the SELECT button to display the adjustment dialog box. Use the Point ◀▶ buttons to adjust the setting value.

Contrast

Press the Point ◀ button to decrease the contrast; press the Point ► button to increase the contrast (from 0 to 63).

Brightness

Press the Point ◀ button to decrease the brightness; press the Point ► button to increase the brightness (from 0 to 63).

Color temp.

Use the Point ◀▶ buttons to select the desired Color temp. level (XLow, Low, Mid, or High).

White balance (Red)

Press the Point ◀ button to lighten red tone; press the Point ► button to deepen red tone (from 0 to 63).

White balance (Green)

Press the Point ◀ button to lighten green tone; press the Point ► button to deepen green tone (from 0 to 63).

White balance (Blue)

Press the Point ◀ button to lighten blue tone; press the Point ► button to deepen blue tone (from 0 to 63).

Sharpness

Press the Point ◀ button to decrease the sharpness of the image; press the Point ► button to increase the sharpness of the image (from 0 to 15).

Gamma

Use the Point ◀▶ buttons to adjust the gamma value to obtain a better balance of contrast (from 0 to 15).

Reset

To reset the adjusted data, select **Reset** and press the SELECT button. A confirmation box appears and then select **Yes**. All adjustments will return to their previous figures.

Image Adjust Menu

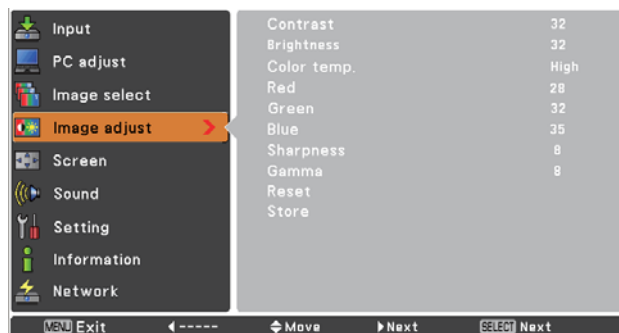

Selected Image mode



Use the Point ◀▶ buttons to adjust the setting value.



✓Note:

- When White balance **Red**, **Green** or **Blue** is adjusted, **Color temp.** will change to **User**.
- When **Blackboard (Green)** or **Colorboard** is selected in Image select, **Color temp.** will change to **Blackboard** or **Colorboard**.

Store

To store the adjusted data, select **Store** and press the Point **▶** or the **SELECT** button. Use the Point **▲▼** buttons to select one from **Image 1** to **4** and press the **SELECT** button. A confirmation box appears and then select **Yes**. Stored data can be called up by selecting an **Image (1–4)** in the Image Mode Selection on page 33.



A confirmation box appears and then select **Yes**.

Screen Size Adjustment

This projector has the picture screen resize function, which enables you to customize the image size.

- 1 Press the **MENU** button to display the On-Screen Menu. Use the Point **▲▼** buttons to select **Screen** and then press the Point **▶** or the **SELECT** button.
- 2 Use the Point **▲▼** buttons select the desired item and then press the **SELECT** button .

Normal

Provide the image to fit the screen size.

True

Provide the image in its original size. When the original image size is larger or smaller than the screen size (1024 x 768), the projector enters to the panning mode automatically. Use the Point **▲▼◀▶** buttons to pan the image. When adjusted, the arrows will turn red. When reached to the correction limits, the arrows will disappear.

Wide

Provide the image to fit the wide video aspect ratio (16:9) by expanding the image width uniformly. This function can be used for providing a squeezed video signal at 16:9.

Full

Provide the full screen image.

✓Note:

- The Screen Menu, except for **Normal** and **Custom**, cannot be operated when **720p**, **1035i**, or **1080i** is selected in the PC System Menu (p.29).
- This projector cannot display any resolution higher than 1920 x 1200. If your computer's screen resolution is higher than it, reset the resolution to the lower before connecting to the projector.
- The image data in other than 1024 x 768 is modified to fit the screen size in initial mode.
- **True**, **Full**, and **Digital zoom +/-** cannot be selected when **480i**, **575i**, **480p** or **575p** is selected in the PC System Menu (p.29).

Screen Menu

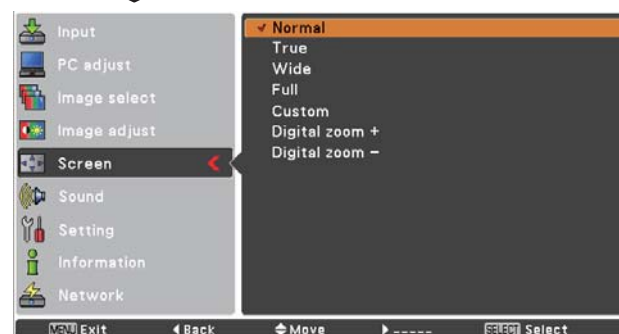
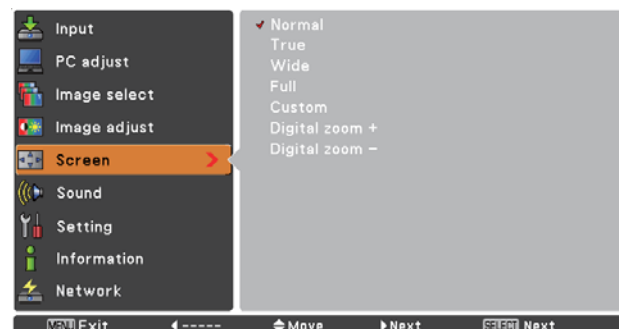

Computer Input

Custom

Adjust the screen scale and position manually with this function.

Press the Point ► button at **Custom** and the **Custom** is displayed on the screen, you can use the Point ▲▼ buttons to choose the item you want to adjust.

- Scale H/V** Adjust the Horizontal/Vertical screen scale.
- H&V** When set to **On**, the aspect ratio is fixed. The **Scale V** appears dimmed and becomes unavailable. Adjust **Scale H**, then the screen scale is automatically modified based on the aspect ratio.
- Position H/V** Adjust the Horizontal/Vertical screen position.
- Common** Save the adjusted scale or position to all the inputs. Press the **SELECT** button at **Common** to display a confirmation box. To save the scale or position, press the **SELECT** button at **Yes**. When **Custom** is selected, the saved scale or position is used.
- Reset** Reset the all adjusted values. Press the **SELECT** button at **Reset** to display a confirmation box. To reset, press the **SELECT** button at **Yes**.

For zooming in and out the images

Digital zoom +

Select **Digital zoom +**. The On-Screen Menu disappears and **D. zoom +** appears. Press the **SELECT** button to expand the image size. Use the Point ▲▼◀▶ buttons to pan the image. The Panning function can work only when the image is larger than the screen size.

A projected image can be also expanded by pressing the **D.ZOOM ▲** or the **SELECT** button on the remote control.

Digital zoom -

Select **Digital zoom -**. The On-Screen Menu disappears and **D. zoom -** appears. Press the **SELECT** button to compress image size.

The projected image can be also compressed by pressing the **D.ZOOM ▼** or the **SELECT** button on the remote control.

To exit the Digital zoom +/- mode, press any button except the **D.ZOOM ▲▼** buttons, **SELECT** and Point buttons.

To return to the previous screen size, select a screen size from the Screen Size Adjustment Menu or select an input source from the Input Source Selection Menu (see pages 27-28) again, or adjust the screen size with the **D.ZOOM ▲▼** buttons.



✓ Note:

- When no signal is detected, **Normal** is set automatically and the Aspect dialog box disappears.
- The adjustable range for **Scale H/V** and **Position H/V** is limited depending on the input signal.

Remote Control

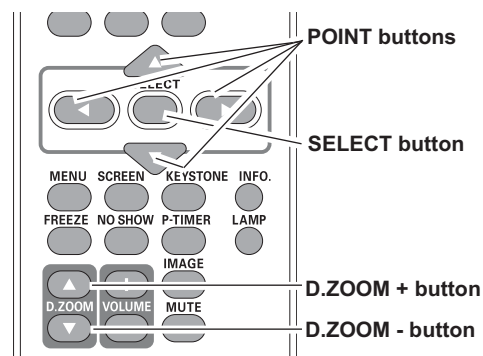

✓ Note:

- The panning function may not operate properly if the stored Mode in the PC adjust Menu is used (p.32).
- The minimum compression ratio is limited depending on the input signal, when the Keystone function is working or when the custom is selected for the screen size.
- **True, Full, and Digital zoom +/-** cannot be selected when **480i, 575i, 480p or 575p** is selected in the PC System Menu (p.29).
- **Digital zoom +/-** cannot be selected when **Full or True** is selected.
- When **Custom** is selected, the Digital zoom - function is disabled.

Video Input

Input Source Selection (Video, S-video)

Direct Operation

Choose **Video** or **S-video** by pressing the INPUT button on the top control or the VIDEO button or the S-VIDEO button on the remote control.

Before using INPUT button, correct input source should be selected through menu operation as described below.

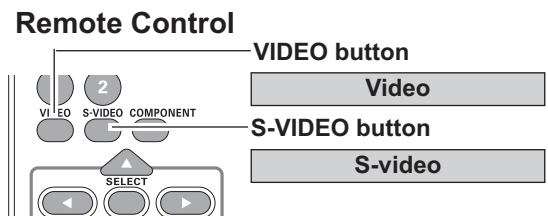
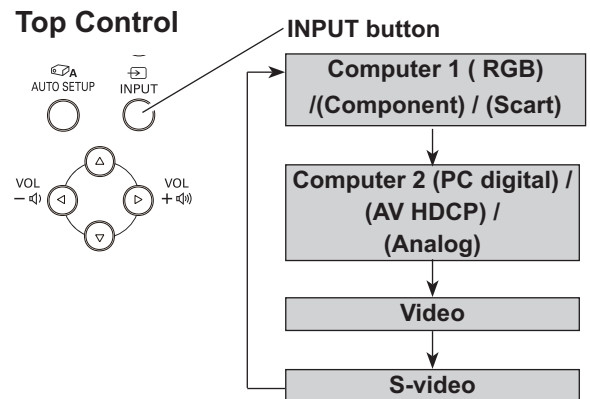

Menu Operation

- 1 Press the MENU button to display the On-Screen Menu. Use the Point ▲▼ buttons to select **Input** and then press the Point ► or the SELECT button.
- 2 Use the Point ▲▼ buttons to select either **Video** or **S-video** and then press the SELECT button.

Video When video input signal is connected to the VIDEO jack, select **Video**.

S-video When video input signal is connected to the S-VIDEO jack, select **S-video**.

Input Menu



✓ **Note:**
When the Input Search function is set to **On1** or **On2** in the Auto setup function, the input signal will be searched automatically (p.45).

Video Input

Input Source Selection (Component, RGB Scart 21-pin)

Direct Operation

Choose **Computer 1 (Component)** or **Computer 1 (Scart)** by pressing the INPUT button on the top control or press the COMPONENT button or the COMPUTER 1 on the remote control. Before using INPUT button, correct input source should be selected through Menu operation as described below.

Remote Control

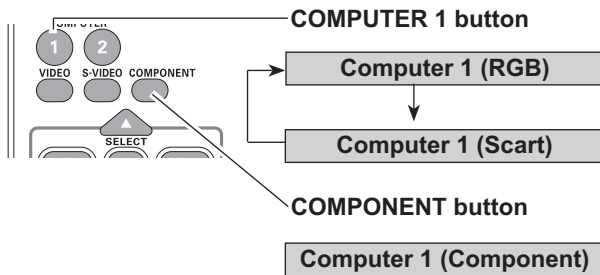

Top Control

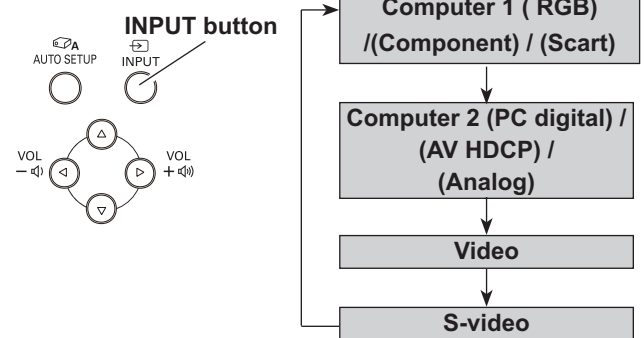

Menu Operation

- 1 Press the MENU button to display the On-Screen Menu. Use the Point ▲▼ buttons to select **Input** and then press the Point ► or the SELECT button.
- 2 Use the Point ▲▼ buttons to select **Computer 1** and then press the Point ► button.
- 3 Use the Point ▲▼ buttons to select **Component** or **RGB(Scart)** and then press the SELECT button.

Component When the input source is coming from video equipment connected to the COMPUTER IN 1/COMPONENT IN terminal with a Component-VGA Cable, select **Component**.

RGB (Scart) When the input source is coming from video equipment connected to the COMPUTER IN 1/COMPONENT IN terminal with a Scart-VGA Cable, select **RGB (Scart)**.

Input Menu

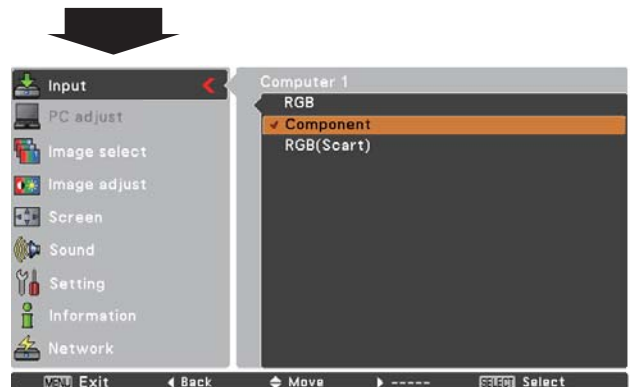
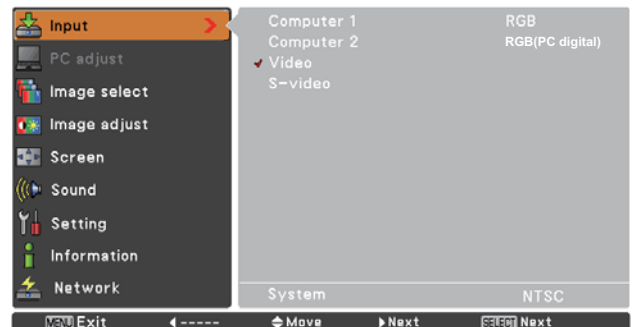

✓ **Note:**

When the Input Search function is set to **On1** or **On2**, the input signal will be searched automatically (p.45).

Video System Selection

- 1 Press the MENU button to display the On-Screen Menu. Use the Point ▲▼ buttons to select **Input** and then press the Point ► or the SELECT buttons.
- 2 Use the Point ▲▼ buttons to select **Video** or **S-video** or **Computer 1(Component)** and then press the SELECT button.
- 3 Use the Point ▲▼ buttons to select **System** and then press the Point ► or the SELECT button. Use the Point ▲▼ buttons to select the desired system and then press the SELECT button.

Video or S-video

Auto

The projector automatically detects an incoming video system, and adjusts itself to optimize its performance. When Video System is **PAL-M** or **PAL-N**, select the system manually.

PAL/SECAM/NTSC/NTSC4.43/PAL-M/PAL-N

If the projector cannot reproduce proper video image, select a specific broadcast signal format from among **PAL**, **SECAM**, **NTSC**, **NTSC 4.43**, **PAL-M**, and **PAL-N**.

Component

Auto

The projector automatically detects an incoming video signal, and adjusts itself to optimize its performance.

COMPONENT VIDEO SIGNAL FORMAT

If the projector cannot reproduce proper video image, select a specific component video signal format from among **480i**, **575i**, **480p**, **575p**, **720p**, **1035i**, and **1080i**.

✓ **Note:**

The AV System Menu cannot be selected when selecting **RGB (Scart)**.

AV System Menu (Video or S-video)

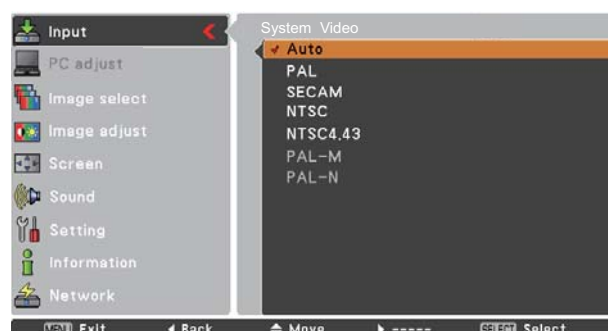
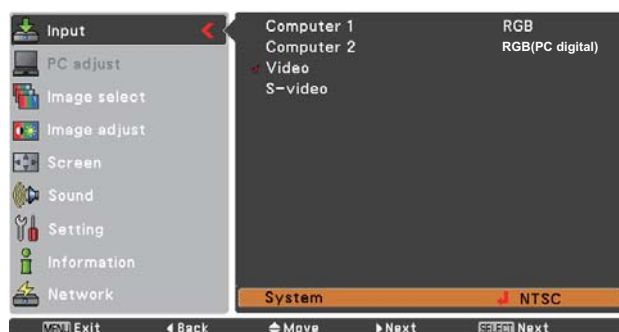

AV System Menu (Component)

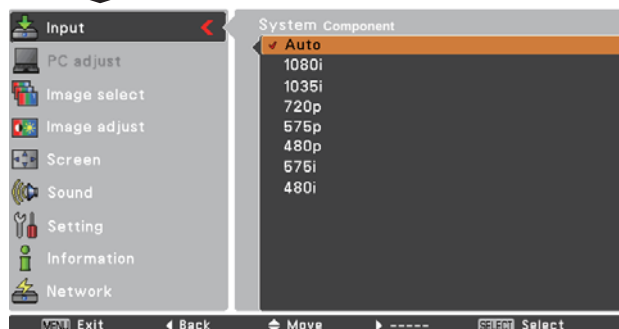

Image Mode Selection

Direct Operation

Select the desired image mode among **Dynamic**, **Standard**, **Cinema**, **Blackboard (Green)**, **Colorboard**, **Image 1**, **Image 2**, **Image 3** and **Image 4** by pressing the IMAGE button on the remote control.

Menu Operation

- 1 Press the MENU button to display the On-Screen Menu. Use the Point ▲▼ buttons to select **Image select** and then press the Point ► or the SELECT button.
- 2 Use the Point ▲▼ buttons to select the desired item and then press the SELECT button .

Remote Control

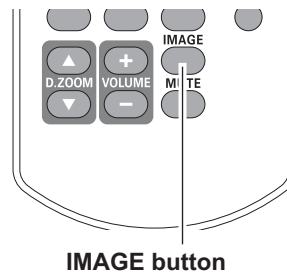
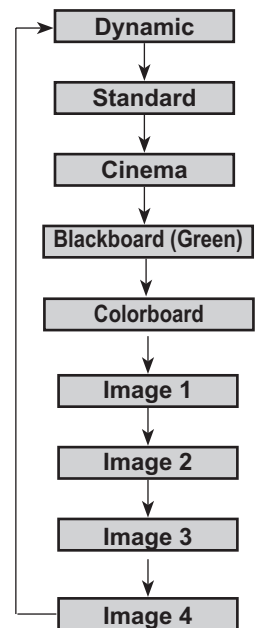

IMAGE button



Dynamic

For viewing pictures in a bright room.

Standard

Normal picture mode preset on the projector.

Cinema

Picture mode adjusted with fine tone.

Blackboard (Green)

For the image projected on a blackboard.
This mode help enhance the image projected on a blackboard. This is mainly effective on a green colored board, not truly effective on a black colored board.

Colorboard

At the time of simple projection on the colored wall, you can get the close color image to the color image projected on a white screen by selecting the similar color to the wall color from the preset four colors.

Image 1-4

For viewing with the user preset image mode in the Image Adjust Menu (see pages 41-42). This Image memory is provided in each computer, scart, component, S-video and video input source.

Image select Menu

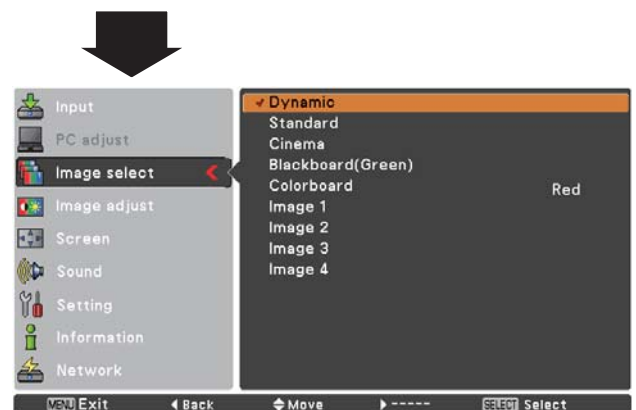
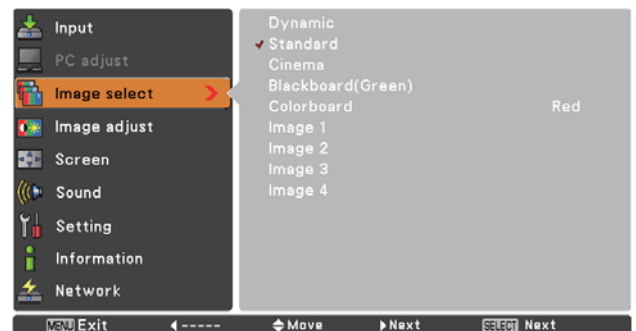

Image Adjustment

- 1 Press the MENU button to display the On-Screen Menu. Use the Point ▲▼ buttons to select **Image adjust** and then press the Point ► or the SELECT button.
- 2 Use the Point ▲▼ buttons select the desired item and then press the SELECT button to display the adjustment dialog box. Use the Point ◀▶ buttons to adjust the setting value.

Contrast

Press the Point ◀ button to decrease the contrast; press the Point ► button to increase the contrast (from 0 to 63).

Brightness

Press the Point ◀ button to decrease the brightness; press the Point ► button to increase the brightness (from 0 to 63).

Color

Press the Point ◀ button decrease the intensity of the color; press the Point ► button increase the intensity of the color (from 0 to 63).

Tint

Press the Point ◀▶ buttons to adjust the tint value to get a proper color balance (from 0 to 63).

Color temp.

Use the Point ◀▶ buttons to select the desired Color temp. level (High, Mid, Low, or XLow).

White balance (Red)

Press the Point ◀ button to lighten red tone; press the Point ► button to deepen red tone (from 0 to 63).

White balance (Green)

Press the Point ◀ button to lighten green tone; press the Point ► button to deepen green tone (from 0 to 63).

White balance (Blue)

Press the Point ◀ button to lighten blue tone; press the Point ► button to deepen blue tone (from 0 to 63).

✓ Note:

- When the **White balance Red, Green or Blue** is adjusted, the Color temp. level will change to **User**.
- Tint cannot be selected when the video system is **PAL, SECAM, PAL-M or PAL-N** (p.39).
- When **Blackboard(Green)** or **Colorboard** is selected in Image select, **Color temp.** will change to **Blackboard** or **Colorboard**.

Image Adjust Menu



Selected Image mode



Use the Point ◀▶ buttons to adjust the setting value.



Video Input

Sharpness

Press the Point ◀ button to decrease the sharpness of the image; press the Point ▶ button to increase the sharpness of the image (from 0 to 15).

Gamma

Use the Point ◀▶ buttons to adjust the gamma value to obtain a better balance of contrast (from 0 to 15).

Noise reduction

Noise interference on the screen can be reduced. Select one of the following options to get smoother images.

- Off..... Disabled.
- L1 Lower reduction
- L2 Higher reduction

Progressive

An interlaced video signal can be displayed in progressive mode. Select one of the following options.

- Off..... Disabled.
- L1 For an active picture.
- L2 For a still picture.
- Film..... For watching a film. With this function, the projector reproduces pictures faithful to the original film quality.

Reset

To reset the adjusted data, select **Reset** and press the SELECT button. A confirmation box appears and then select **Yes**. All adjustments will return to their previous figures.

Store

To store the adjusted data, select **Store** and press the Point ▶ or the SELECT button. Use the Point ▲▼ buttons to select one from Image 1 to 4 and press the SELECT button. A confirmation box appears and then select **Yes**. Stored data can be called up by selecting an **Image (1–4)** in the Image Mode Selection on page 40.

✓ **Note:**

Noise reduction and **Progressive** cannot be selected when **480p**, **575p**, **720p**, **1035i** or **1080i** is selected (p.39).

Store Menu

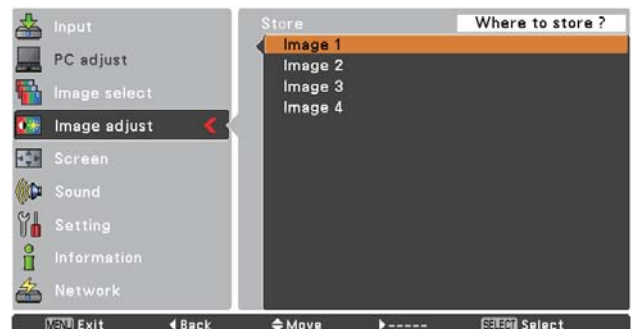

A confirmation box appears and then select **Yes**.

Screen Size Adjustment

This projector has the picture screen resize function, which enables you to customize the image size.

- 1 Press the MENU button to display the On-Screen Menu. Use the Point ▲▼ buttons to select **Screen** and then press the Point ► or the SELECT button.
- 2 Use the Point ▲▼ buttons select the desired item and then press the SELECT button.

Normal

Provide the image at the 4:3 normal video aspect ratio.

Wide

Provide the image at the 16:9 wide screen ratio.

Custom

Adjust the screen scale and position manually with this function.

Press the Point ► button at **Custom** and the **Custom** is displayed on the screen, you can use the Point ▲▼ buttons to choose the item you want to adjust.

- Scale H/V** Adjust the Horizontal/Vertical screen scale.
- H&V** When set to **On**, the aspect ratio is fixed. The **Scale V** appears dimmed and becomes unavailable. Adjust **Scale H**, then the screen scale is automatically modified based on the aspect ratio.
- Position H/V** Adjust the Horizontal/Vertical screen position.
- Common** Save the adjusted scale or position to all the inputs. Press the SELECT button at **Common** to display a confirmation box. To save the scale or position, press the SELECT button at **Yes**. When **Custom** is selected, the saved scale or position is used.
- Reset** Reset the all adjusted values. Press the SELECT button at **Reset** to display a confirmation box. To reset, press the SELECT button at **Yes**.

Screen Menu

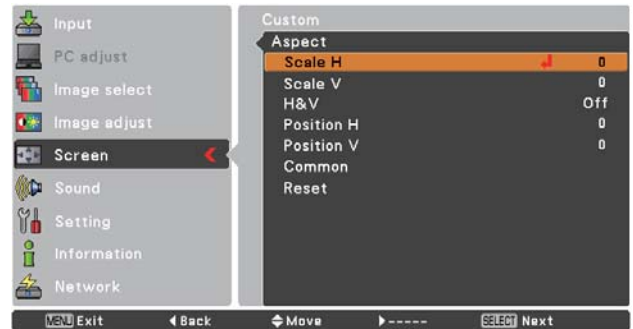

✓Note:

- When no signal is detected, **Normal** is set automatically and the Aspect dialog box disappears.
- The adjustable range for **Scale H/V** and **Position H/V** is limited depending on the input signal.
- **Wide** cannot be operated when **720p**, **1035i** or **1080i** is selected in the AV System Menu (p.39).

Setting

Setting

This projector has a Setting menu that allows you to set up the other various functions described below.

- 1 Press the MENU button to display the On-Screen Menu. Press the Point ▲▼ buttons to select **Setting** and press the Point ► or the SELECT button to access the submenu items.
- 2 Use the Point ▲▼ buttons to select the desired item and then press the Point ► or the SELECT button to access the selected item.
- 3 Use the Point ▲▼ buttons select the desired item and then press the SELECT button.

Language

The language used in the On-Screen Menu is available in **English, German, French, Italian, Spanish, Portuguese, Dutch, Swedish, Finnish, Polish, Hungarian, Romanian, Russian, Chinese, Korean, Japanese and Thai.**

Menu position

This function is used to change the position of the On-Screen Menu. Select **Menu position** and press the SELECT button.

The Menu position changes each time you press SELECT button as follows.

the top left → the top right → the center → the bottom left
→ the bottom right → the top left →.....

Setting Menu

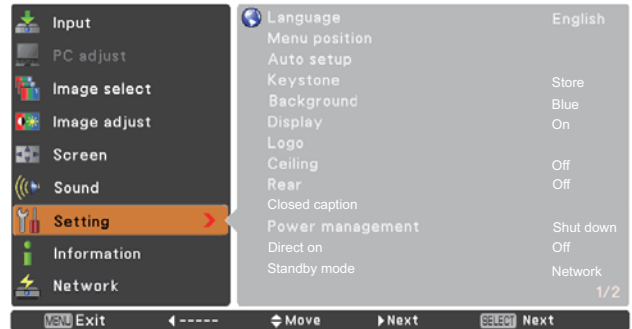

Language

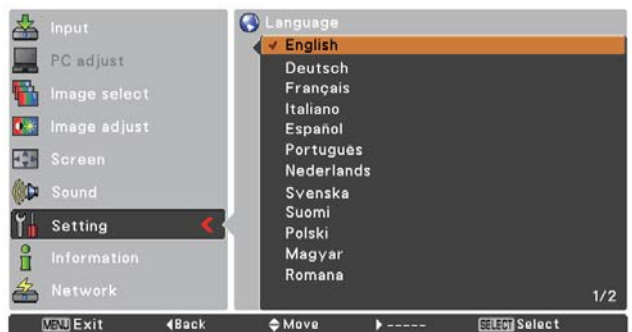
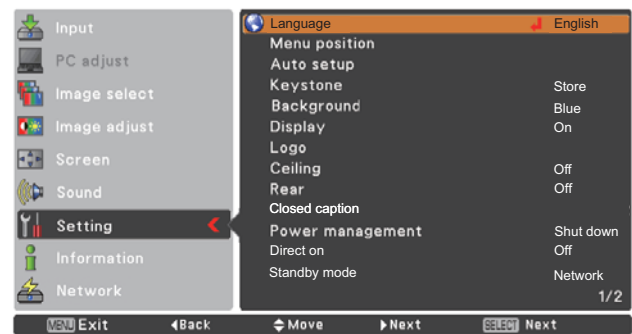

Auto setup

This function enables Input search, Auto Keystone correction and Auto PC adjustment by pressing the AUTO SETUP button on the top control or the AUTO SET button on the remote control. Settings for those functions can be altered as follows:

Input search

This function detects the input signal automatically. When a signal is found, the search will stop. Use the Point ▲ ▼ buttons to select one of the following options.

- Off** Input search will not work.
- On1**..... Input search works under the following situation.
 - When pressing the AUTO SETUP button on the top control.
 - When pressing the AUTO SET button on the remote control.
- On2**..... Input search works under the following situation.
 - When turning on the projector by pressing the ON/STAND-BY button on the top control or the remote control.
 - When pressing the AUTO SET button on the remote control.
 - When pressing the AUTO SETUP button on the top control.
 - When the current input signal is cut off.*

* If the No show or Freeze function is active, cancel it to activate the Input search. It is also unavailable when On-Screen menu is displayed.

Auto PC adj.

- On** Enables Auto PC Adjustment when pressing the AUTO SET button on the remote control or the AUTO SETUP button on the top control.
- Off** Disables Auto PC Adjustment.

Auto Keystone

- Auto** Always works and corrects keystone distortion according to the projector's tilt.
- Manual** Works only when pressing the AUTO SETUP button on the top control or the AUTO SET button on the remote control.
- Off** Disables Auto Keystone.

✓ **Note:**

- While **Input search** is set to **On1** or **On2**, the status of Input and Lamp are displayed every time the signal is switched.
- Only the last selected input source can be detected.
- During **Input search** is in progress, if the INPUT button on the top control, the COMPUTER1/2 button, the S-VIDEO button, the COMPONENT button or the VIDEO button on the remote control, the MENU button or the ON/STAND-BY button is pressed, **Input search** will stop. If the INPUT button is pressed, the **Input search** will go back to the current search signal. If the COMPUTER 1/2 button or VIDEO or S-VIDEO or COMPONENT button is pressed, **Input search** will go back to the button's input signal.
- **Input search**, **Auto PC adj.** and **Auto Keystone** cannot be set **Off** at the same time.

Auto setup

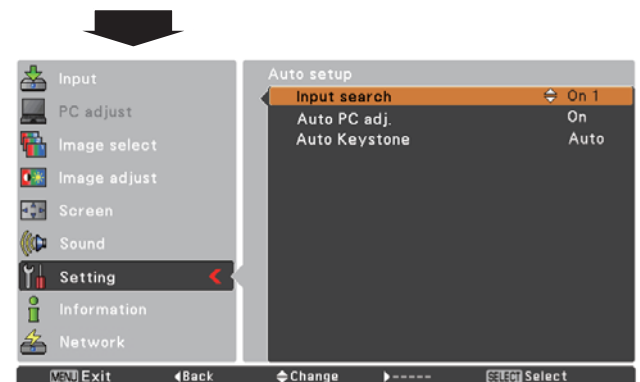
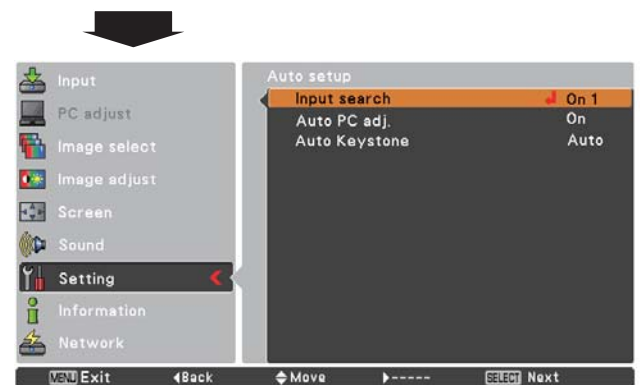
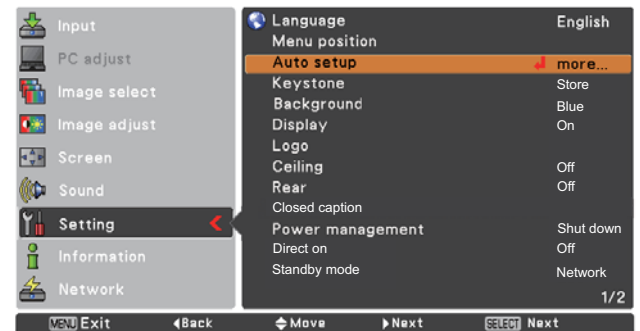

✓ **Note:**

- **Auto Keystone** corrects vertical distortion only, not correct horizontal distortion.
- The Auto Keystone function cannot work when the **Ceiling** feature is set **On** in the Setting menu (p.50).
- Perfect correction of the image distortion cannot be ensured with the Auto setup function. If the distortion is not corrected properly by pressing the AUTO SETUP or the AUTO SET button, adjust manually by pressing the KEYSTONE button on the remote control or selecting **Keystone** in the Setting menu (pp.23, 46).
- **Fine sync**, **Total dots**, **Horizontal** and **Vertical** position of some computers cannot be fully adjusted with the Auto PC Adjustment function. When the image is not provided properly with this operation, manual adjustments are required (pp.31-32).

Keystone

This function is used to store or reset the keystone correction when the AC power cord is unplugged.

Store Keep the keystone correction even when the AC power cord is unplugged.

Reset..... Release the keystone correction when the AC power cord is unplugged.

To correct keystone distortion, press the SELECT button. **Keystone** appears on the screen. Use the Point ▲▼ buttons to correct keystone distortion (p.23).

Background

Select the background screen for when no input signal is detected. Press the Point ▲▼ buttons to switch between each option.

Blue . . . Project a blue background

User . . . Project an image selected in the Logo setting.

Black . . Project a black background

Display

This function decides whether to display On-Screen Displays.

On Show all the On-Screen displays. Use this function when you want to project images after the lamp becomes bright enough. The factory default setting is in this option.

Countdown Off..... Show the input image instead of the countdown when turning on the projector. Use this function when you want to project the image as early as possible even when the lamp is not bright enough.

Off Hide the On-Screen Displays except;

- On-Screen Menu
- **Power off?** (p.20)
- **No signal** for Power management (p.51)
- **Please wait ...**
- Arrows for the True function in the Screen Menu (p.35)
- **P-Timer**

Keystone

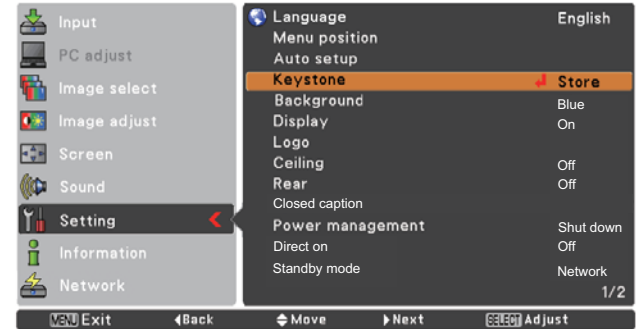

Logo (Logo and Logo PIN code lock settings)

This function allows you to customize the screen logo with **Logo select**, **capture**, **Logo PIN code lock** and **Logo PIN code change** functions.

✓ **Note:**

When **On** is selected in the Logo PIN code lock function, **Logo select** and **Capture** functions cannot be selected.

Logo select

This function decides on the starting-up display from among following options.

- Off** Show the countdown display only.
- Default** Show the factory-set logo.
- User** Show the image you captured.

Logo select

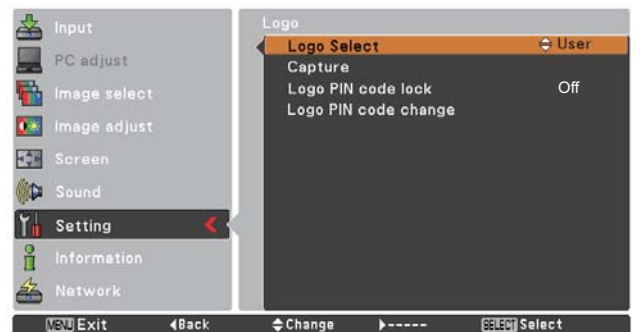
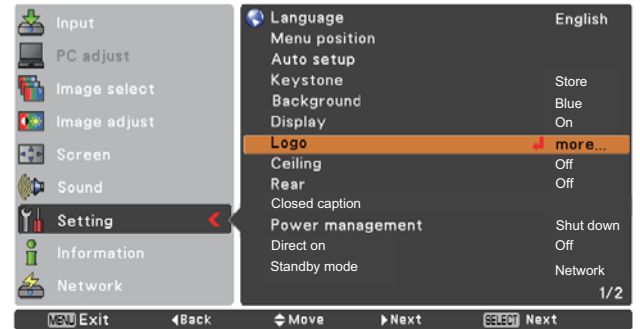

Capture

This function enables you to capture an image being projected to use it for a starting-up display or interval of presentations.

Select **Capture** and press the SELECT button. A confirmation box appears and select **Yes** to capture the projected image.

After capturing the projected image, go to the Logo select function and set it to **User**. Then the captured image will be displayed the next time you turn on the projector.

To cancel the capture function, select **Yes** in the "Quit?" confirmation box.

✓ Note:

- Before capturing an image, select **Standard** in the Image select Menu to capture a proper image (pp.33, 40).
- A signal from a computer can be captured up to XGA (1024 x 768). A signal from video equipment can be captured except for 720p, 1035i, and 1080i.
- When capturing the image that has been adjusted by the Keystone function, the adjusted data is automatically reset and the projector captures an image without keystone correction.
- When **Logo PIN code lock** is set to **On**, **capture** cannot be selected.
- When starting to capture a new image, the previously stored image is cleared even if you cancel the capturing.
- When there is no captured image or it is interrupted while capturing an image, **User** cannot be selected, you can only switch between **Default** and **Off**.

Logo PIN code lock

This function prevents an unauthorized person from changing the screen logo.

Off..... The screen logo can be changed freely from the Logo Menu (p.47).

On..... The screen logo cannot be changed without a Logo PIN code.

If you want to change the **Logo PIN code lock** setting, press the SELECT button and the Logo PIN code dialog box appears. Enter a Logo PIN code by following the steps below. The initial **Logo PIN code** is set to "4321" at the factory.

Capture

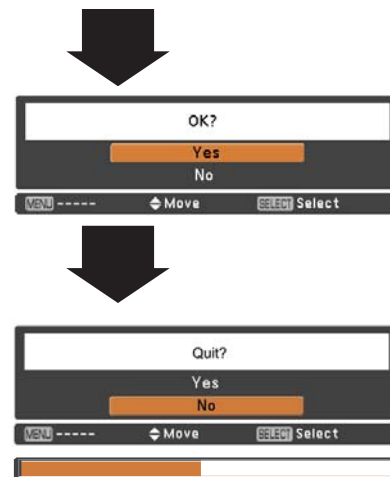
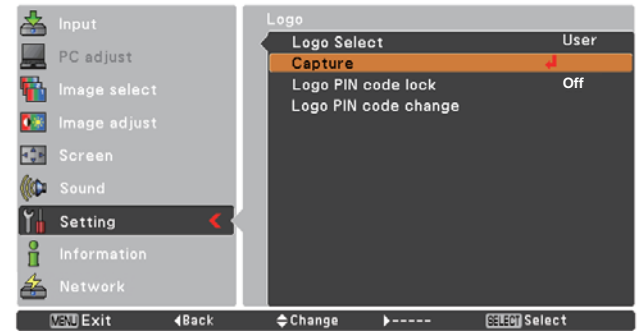

Logo PIN code lock

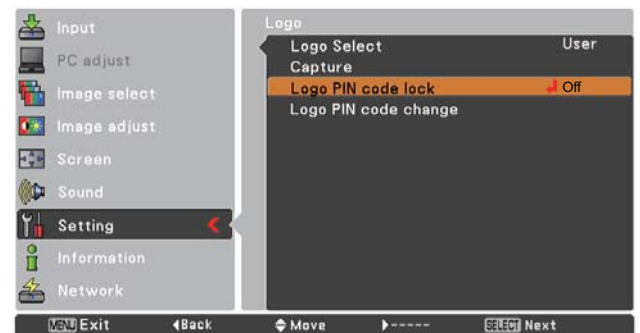

Enter a Logo PIN code

Use the Point ▲▼ buttons to enter a number. Press the Point ► button to fix the number and move the red frame pointer to the next box. The number changes to *. If you fixed an incorrect number, use the Point ◀ button to move the pointer to the number you want to correct, and then enter the correct number.

Repeat this step to complete entering a four-digit number.

After entering the four-digit number, move the pointer to **Set**. Press the SELECT button so that you can start to operate the projector.

If you entered an incorrect Logo PIN code, **Logo PIN code** and the number (***) will turn red for a moment. Enter the correct Logo PIN code all over again.

Change the Logo PIN code lock setting

Use the Point ▲▼ buttons to switch **On** or **Off**, and then press the SELECT button to make a choice.

Logo PIN code change

Logo PIN code can be changed to your desired four-digit number. Press the SELECT button to select **Logo PIN code change**. **Logo PIN code change** dialog box appears, use the Point ▲▼ buttons to enter the current code. The New Logo PIN code input dialog box appears. Set a new Logo PIN code, confirmation box appears, choose **Yes** to set the new Logo PIN code.

Be sure to note the new Logo PIN code and keep it on hand. If you lost the number, you could no longer change the Logo PIN code setting.

CAUTION:
WHEN YOU HAVE CHANGED THE LOGO PIN CODE, WRITE DOWN THE NEW PIN CODE IN COLUMN OF THE LOGO PIN CODE NO. MEMO ON PAGE 77, AND KEEP IT SECURELY. SHOULD THE LOGO PIN CODE BE LOST OR FORGOTTEN, THE LOGO PIN CODE SETTING CAN NO LONGER BE CHANGED.

Enter a Logo PIN code

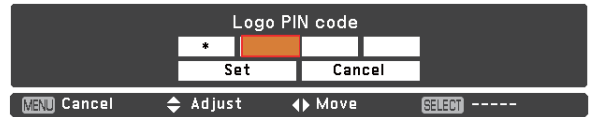

After a correct Logo PIN code is entered, the following dialog box appears.

Change the Logo PIN code lock setting

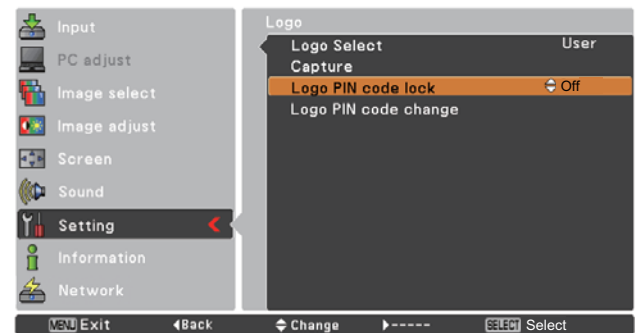

Change the Logo PIN code

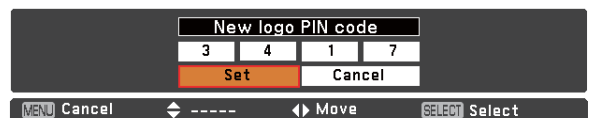
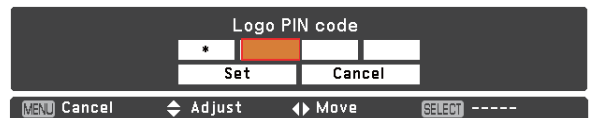
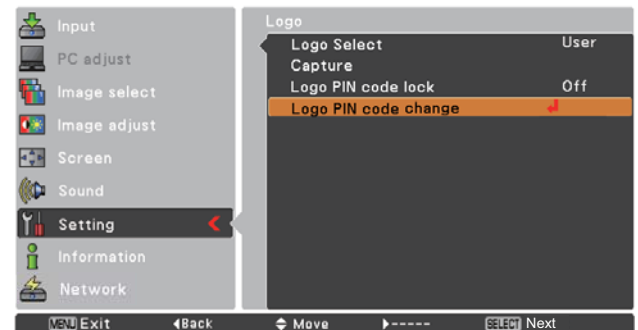

Setting

Ceiling

When this function is set to **On**, the picture will be top/bottom and left/right reversed. This function is used to project the image from a ceiling-mounted projector.

Rear

When this function is set to **On**, the picture will be left/right reversed. This function is used to project the image from rear of the screen.

Ceiling

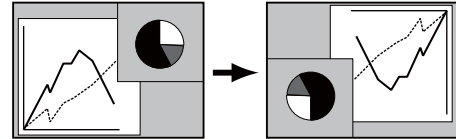

Rear

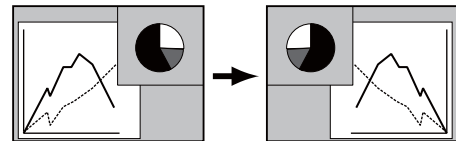

Closed Caption

Closed Caption is a printed version of the program sound or other information displayed on the screen. If the input signal contains closed captions, you can turn on the feature and switch the channels. Press the Point **▲▼** buttons to select **Off**, **CC1**, **CC2**, **CC3** or **CC4**.

If the closed caption is not clear, you can change the text from **Color** to **White**.

✓ Note:

The Closed Caption is available only under the situation below.

- When the input signal is **NTSC** of composite and S-video, and the system is set according to the signal or set on **Auto**.
- The system must be set on **NTSC** or **Auto** in Video System Selection. (p.39)
- The item of Closed Caption is displayed in gray while it is not available.
- The Closed caption is unavailable when On-Screen menu and P-Timer are displayed.

Closed Caption

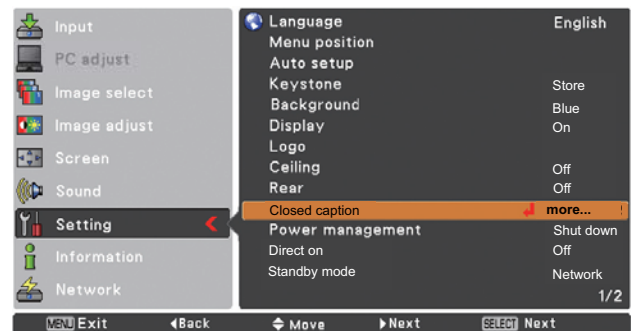

Press the Point **▲▼** buttons to select **Off**, **CC1**, **CC2**, **CC3** or **CC4**, and then Press **SELECT** button.

Power management

For reducing power consumption as well as maintaining the lamp life, the Power management function turns off the projection lamp when the projector is not operated for a certain period.

Select one of the following options:

- Ready** When the lamp has been fully cooled down, the POWER indicator changes to green blinking. In this condition, the projection lamp will be turned on if the input signal is reconnected or any button on the top control or remote control is pressed.
- Shut down** When the lamp has been fully cooled down, the power will be turned off.
- Off** Power management function is off.
- Timer** If the input signal is interrupted and no button is pressed for more than 30 seconds, the timer display with **No signal** appears. It starts the countdown until the lamp is turned off. Use the Point ▲▼ buttons to set the Timer (1~30 min).

✓ **Note:**
Factory default is **Shut down: 30 min.**

Power management



Time left before Lamp is off.

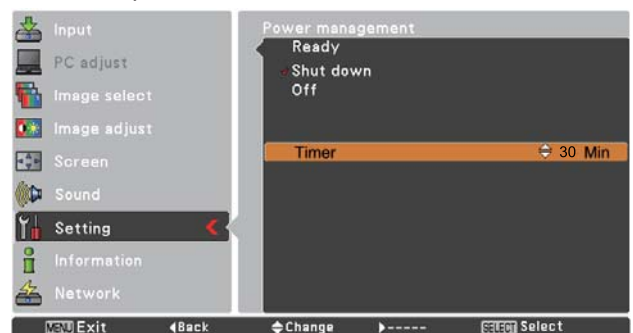
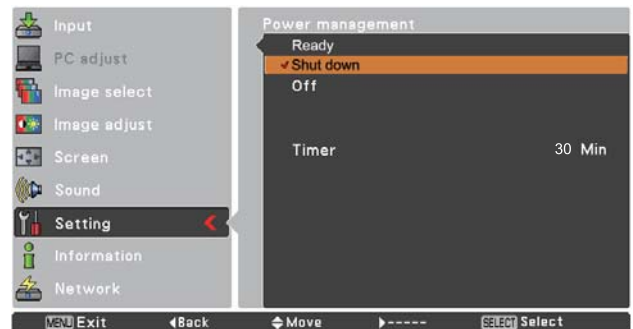
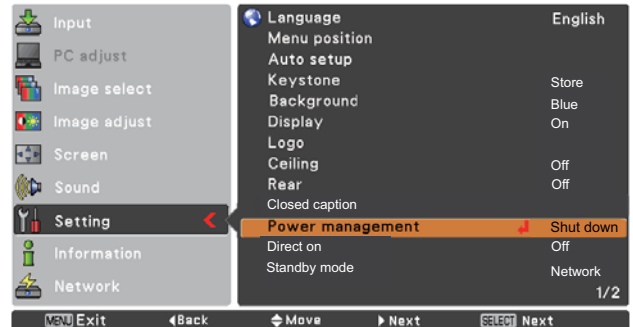

Direct on

When this function is set to **On**, the projector will be automatically turned on just by connecting the AC power cord to a wall outlet.

✓ **Note:**

Be sure to turn off the projector properly (see “Turning Off the Projector” on page 20). If the projector is turned off in the incorrect sequence, the Direct on function does not work properly.

Standby mode

This function is available when operating the projector via network.

Network Supply the power to the network function even after turning off the projector. You can turn on/off the projector via network, modify network environment, and receive an e-mail about projector status while the projector is powered off.

Eco Select **Eco** when you do not use the projector via network. The projector's network function will stop when turning off the projector.

Refer to the owner's manual “Network Set-up and Operation”.

✓ **Note:**

When selecting **Network**, the cooling fans may be running depending on the temperature inside the projector even if the projector is turned off.

Lamp control

Lamp control

This function allows you to change brightness of the screen.

- 💡 **Normal** Normal brightness
- 💡 **Eco** Lower brightness reduces the lamp power consumption and extends the lamp life.

Lamp life control

Select the lamp operation when the total lighting time of a lamp exceeds the recommended total hours of use.

Mode 1 The lamp can be turned on even after exceeding the recommended total hours of use.

Mode 2 The lamp can be turned on even after exceeding the recommended total hours of use. But the projector turns off automatically after 3 minutes.

✓ **Note:**

- Lamp mode cannot be changed for a while after turning on the projector. Lamp needs some time to stabilize after the power is turned on. Stored lamp mode will be active after the lamp is stabilized.
- If **Mode 2** has been selected and the projection lamp exceeds the recommended total hours of use, the replacement icon will be displayed at the time of power-on. Then the projector will turn off after 3 minutes.

Lamp replacement icon



- The Lamp replacement icon will not appear when the Display function is set to **Off** (p.46), during **Freeze** (p.25), or **No show** (p.26).

Remote control

This projector provides two different remote control codes: the factory-set initial code (**Code 1**) and the secondary code (**Code 2**). This switching function prevents remote control interference when operating several projectors or video equipment at the same time.

When operating the projector in **Code 2**, both the projector and the remote control must be switched to **Code 2**.

To change the code for the projector:

Select either **Code 1** or **Code 2** in this Setting Menu.

To change the code for the remote control:

Press and hold both the MENU and IMAGE buttons together for 5 seconds or more. After changing the code, make sure the remote control operates properly.

✓ **Note:**

- When different codes are set on the projector and on the remote control, any operation cannot be made. In that case, switch the code on the remote control to fit the code on the projector.
- If the batteries are removed from the remote control for a long period of time, the remote control code will be reset.

Lamp life control

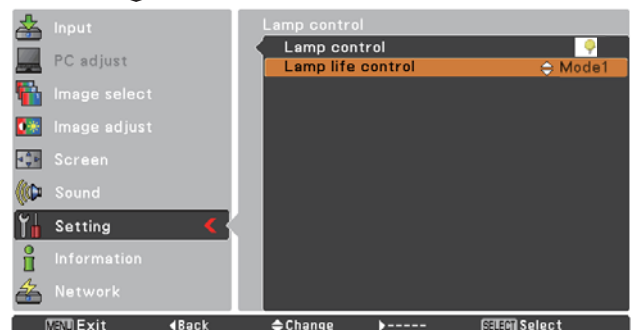
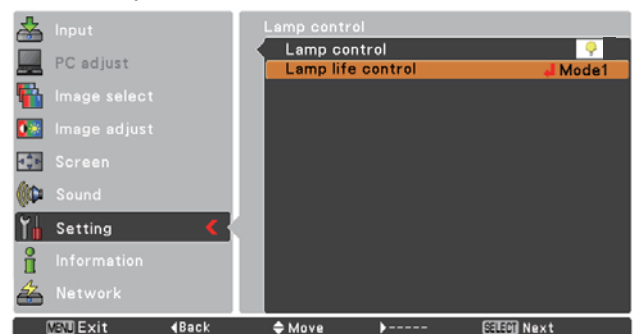
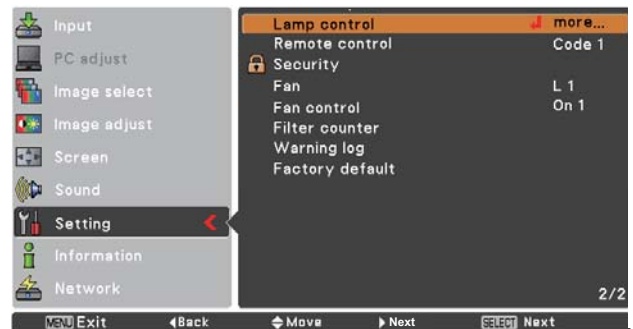

Remote control

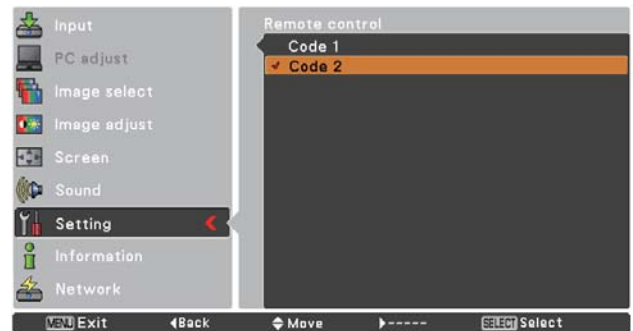



Security (Key lock and PIN code lock)

This function allows you to use the Key lock and PIN code lock function to set the security for the projector operation.

Key lock

This function locks the top control and remote control buttons to prevent operation by unauthorized persons. Select **Key lock** and then press the SELECT button, and select the desired item by pressing the Point ▲ ▼ buttons.

-  Unlocked.
-  Lock the operation of the top control. To unlock, use the remote control.
-  Lock the operation of the remote control. To unlock, use the top control.

If the top control accidentally becomes locked and you do not have the remote control nearby or there is something wrong with your remote control, contact the dealer where you purchased the projector or the service center.

PIN code lock

This function prevents the projector from being operated by unauthorized persons and provides the following setting options for security.

- Off** Unlocked.
- On1** Enter the PIN code every time turning on the projector.
- On2** Enter the PIN code to operate the projector once the power cord is disconnected; as long as the AC power cord is connected, the projector can be operated without a PIN code.

Whenever you change the PIN code lock setting or the PIN code (the four-digit number), you are required to enter the PIN code. The "1234" is set as the initial PIN code at the factory.

If you want to change the PIN code lock setting, Press the SELECT button and the PIN code dialog box appears.

When the projector is locked with the PIN code, the Security icon appears on the guide.

Key lock

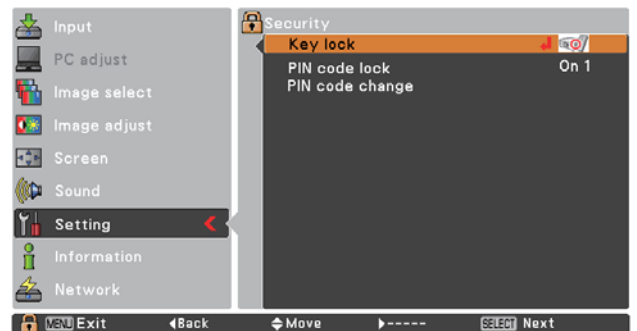
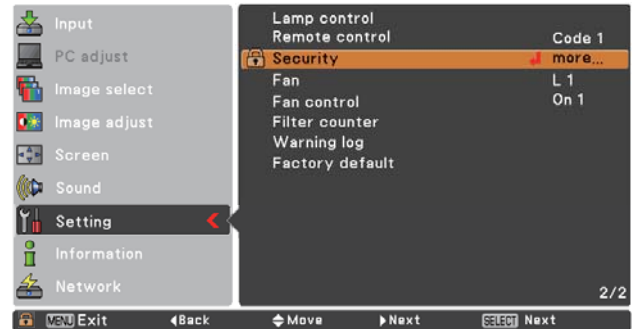

PIN code lock



Enter a PIN code

Use the Point ▲▼ buttons to enter a number. Press the Point ► button to fix the number and move the red frame pointer to the next box. The number changes to *. If you fixed an incorrect number, use the Point ◀ button to move the pointer to the number you want to correct, and then enter the correct number.

Repeat this step to complete entering a four-digit number.

After entering the four-digit number, move the pointer to **Set**. Press the SELECT button so that you can change the following PIN code lock setting.

If you entered an incorrect PIN code, **PIN code** and the number (****) will turn red for a moment. Enter the correct PIN code all over again.

Change the PIN code lock setting

Use the Point ▲▼ buttons to select **Off**, **On1** or **On2**, and then press the SELECT button to make a choice.

Change the PIN code

The PIN code can be changed to your desired four-digit number. Press the SELECT button to select **PIN code change**. Pin code dialog box appears, use the Point ▲▼ buttons to enter the current code. The New PIN code input dialog box appears. Set a new PIN code.

Enter a PIN code

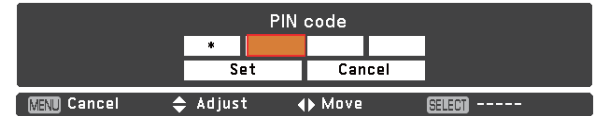

Change the PIN code

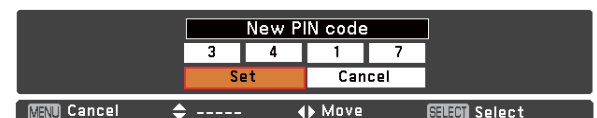
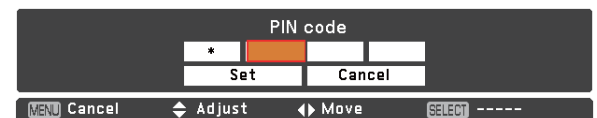

CAUTION:
WHEN YOU HAVE CHANGED THE PIN CODE, WRITE DOWN THE NEW PIN CODE IN COLUMN OF THE PIN CODE NO. MEMO ON PAGE 77, AND KEEP IT SECURELY. IF YOU FORGET YOUR PIN CODE, THE PROJECTOR CAN NO LONGER BE STARTED.

Setting

Fan

This function provides the following options in the cooling fans' operation when the projector is turned off (p.20).

- L1 Normal operation
- L2 Slower and lower-sound than the normal operation (L1), but it takes more time to cool the projector down.

Fan control

This projector provides Fan control function in the Setting menu.

Choose the running speed of cooling fans from the following options according to the ground elevation under which you use the projector.

- Off..... Normal speed. Set this function to **Off** when using the projector in non-high altitude environment.
- On 1..... Faster than Off mode. Select this mode when using the projector in high altitudes (about 1,200 meters or more above the sea level) where the fans have less cooling effect.
- On 2..... Faster than On 1 mode. Select this mode when using the projector in higher altitudes than above where the fans have lesser cooling effect.

✓ **Note:**

The fan noise becomes louder in **On 1** and **On2**.

Filter counter

This function is used to set a frequency for the filter cleaning.

When the projector reached a specified time between cleanings, a Filter warning icon appears on the screen, notifying the cleaning is necessary. After cleaning the filter, be sure to select **Reset** and set the timer. The Filter warning icon will not turn off until the filter counter is reset.

For details about resetting the timer, refer to "Resetting the Filter Counter" on page 60.

Fig.1 Filter warning icon

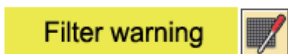

Filter warning icon appears on the screen at a set time.

✓ **Note:**

This icon also appears at turning on.

✓ **Note:**

The Filter warning icon (Fig.1) will not appear when the Display function is set to **Off** (p.46), during **Freeze** (p.25), or **No show** (p.26).

Filter counter



Press the SELECT button to select **Timer**, and then use the Point ▲ ▼ buttons to set the timer. Select from (**Off/ 100H/ 200H/ 300H**) depending on the use environment.

Warning log

This function records anomalous operations while the projector is in operation and use it when diagnosing faults. Up to 10 warning logs are displayed with the latest warning message at the top of the list, followed by previous warning messages in chronological order.

✓ **Note:**

When the Factory default function is executed, all the warning log records will be deleted.

Factory default

This function returns all setting values except for the **User logo**, **PIN code lock**, **Logo PIN code lock**, **Lamp counter** and **Filter counter** to the factory default settings.

Factory default

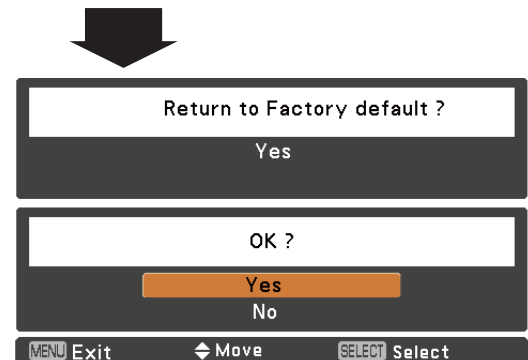
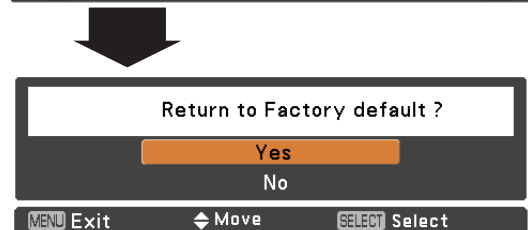
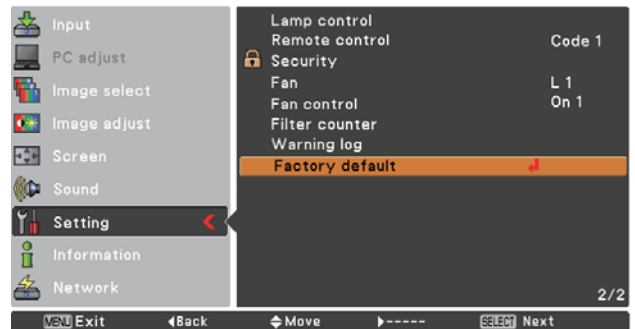

Information

Input Source Information Display

The Information Menu is used for checking the status of the image signal being projected and the operation of the projector.

Direct Operation

Press the INFO. button on the remote control to display the Information Menu.

Menu Operation

Press the Point ▲▼ buttons to select the Information. The Information Menu is displayed.

See below for displayed information.

Input

The selected input source is displayed.

H-sync freq.

The horizontal frequency of the input signal is displayed in **KHz**, or - - - - - **KHz** when no signal.

V-sync freq.

The vertical frequency of the input signal is displayed in **Hz**, or - - - - - **Hz** when no signal. Numbers of Hz doubles when during Interlace.

Screen

The selected screen size is displayed.

Language

The selected language is displayed.

Lamp status

The selected lamp mode is displayed.

Lamp counter

The cumulative lamp operating time is displayed.

Power management

Off, **Ready**, **Shut down** or **Timer** is displayed.

Key lock

The selected Key lock icon is displayed.

PIN code lock

Off or **On 1** or **On 2** is displayed.

Remote control

The selected remote code is displayed.

Remote Control

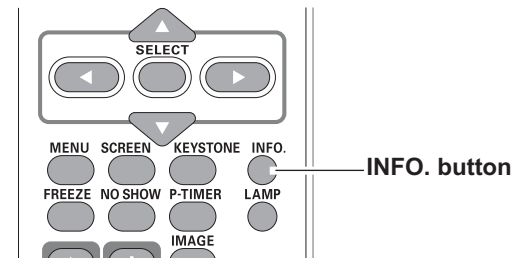

Information Menu

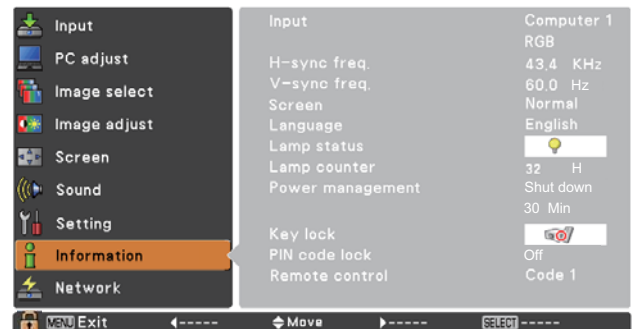

Maintenance and Cleaning

WARNING indicator

The WARNING indicator shows the state of the function which protects the projector. Check the state of the WARNING indicator and the POWER indicator to take proper maintenance.

The projector is shut down and the WARNING indicator is blinking red.

When the temperature inside the projector reaches a certain level, the projector will be automatically shut down to protect the inside of the projector. The POWER indicator is blinking while the projector is being cooled down. When the projector has cooled down enough (to its normal operating temperature), it can be turned on again by pressing the ON/STAND-BY button.

✓Note:

The WARNING indicator continues to blink even after the temperature inside the projector returns to normal. When the projector is turned on again, the WARNING indicator stops blinking.

Then check the matters below:

- Did you provide appropriate space for the projector to be ventilated? Check the installing condition to see if the air vents of the projector are not blocked.
- Has the projector been installed near an Air-Conditioning/ Heating Duct or Vent? Move the installation of the projector away from the duct or vent.
- Is the filter clean? Clean the filter periodically.

The projector is shut down and the WARNING indicator lights red.

When the projector detects an abnormal condition, it is automatically shut down to protect the inside of the projector and the WARNING indicator lights red. In this case, unplug the AC power cord and reconnect it, and then turn the projector on once again to verify operation. If the projector cannot be turned on and the WARNING indicator still lights red, unplug the AC power cord and contact the service station.



CAUTION

DO NOT LEAVE THE PROJECTOR WITH THE AC POWER CORD CONNECTED UNDER AN ABNORMAL CONDITION. IT MAY RESULT IN FIRE OR ELECTRIC SHOCK.

Top Control

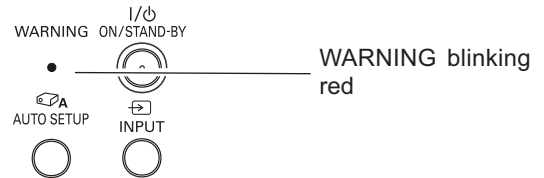

Top Control

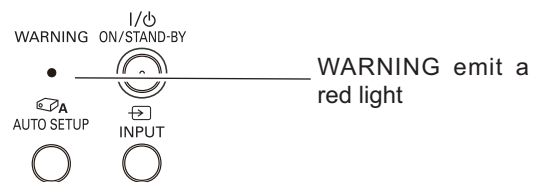

Maintenance and Cleaning

Cleaning the Filters

Filter prevents dust from accumulating on the optical elements inside the projector. Should the filters become clogged with dust particles, it will reduce cooling fans' effectiveness and may result in internal heat buildup and adversely affect the life of the projector. If a "Filter warning" icon appears on the screen, clean the filters immediately. Clean the filters by following the steps below.

- 1 Turn off the projector, and unplug the AC power cord from the AC outlet.
- 2 Turn the projector over and remove the filters .
- 3 Clean the filters softly by using a brush.
- 4 Replace the filters properly. Make sure that the filters are fully inserted to the projector.



CAUTION

Do not operate the projector with the filters removed. Dust may accumulate on the optical elements degrading picture quality. Do not put anything into the air vents. Doing so may result in malfunction of the projector.

RECOMMENDATION

We recommend avoiding dusty/smoky environments when you operate the projector. Usage in these environments may cause poor image quality.

When using the projector under dusty or smoky conditions, dust may accumulate on a lens, LCD panels, or optical elements inside the projector degrading the quality of a projected image. When the symptoms above are noticed, contact your authorized dealer or service station for proper cleaning.

Resetting the Filter Counter

Be sure to reset the Filter counter after cleaning or replacing the filters.

- 1 Press the MENU button to display the On-Screen Menu. Use the Point ▲▼ buttons to select the **Setting** and then press the Point ► or SELECT buttons.
- 2 Use the Point ▲▼ buttons select **Filter counter** and then press the Point ► or SELECT button. Use the Point ▲▼ buttons to select **Filter counter reset** and then press SELECT button. The **Filter counter Reset?** appears. Select **Yes** to continue.
- 3 Another confirmation dialog box appears, select **Yes** to reset the Filter counter.

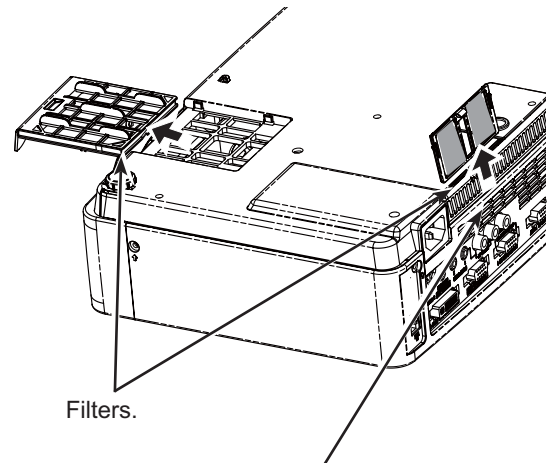

✓Note:

When reinserting this filter, be sure that the slit part is facing the outer side.

Filter counter

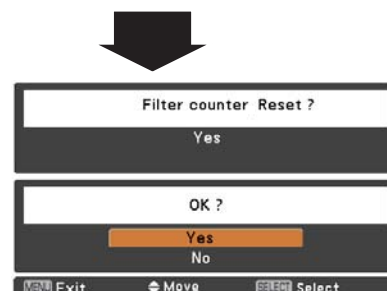
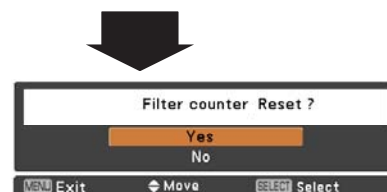

The **Filter counter Reset?** appears. Select **Yes**, then another confirmation box appears. Select **Yes** again to reset the Filter counter.

Attaching the Lens Cap

When moving this projector or while not using it over an extended period of time, replace the lens cap.

Attach the lens cap according to the following procedures.

- 1 Thread the string through the hole on the lens cap and then tie a knot in the string to secure it in place.
- 2 To pass the other end of the string into the hole on the top of the projector and pull at it.

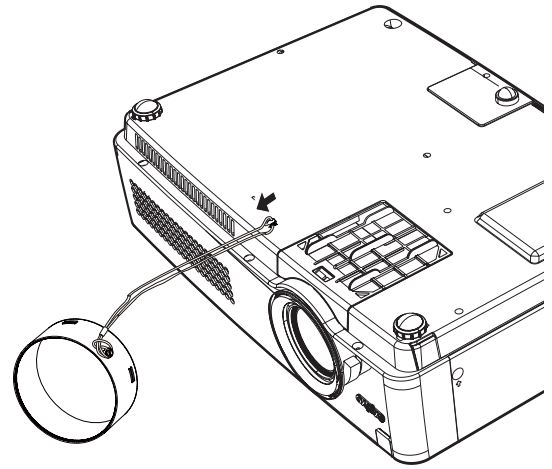

Cleaning the Projection Lens

Unplug the AC power cord before cleaning.

Gently wipe the projection lens with a cleaning cloth that contains a small amount of non-abrasive camera lens cleaner, or use a lens cleaning paper or commercially available air blower to clean the lens.

Avoid using an excessive amount of cleaner. Abrasive cleaners, solvents, or other harsh chemicals might scratch the surface of the lens.

Cleaning the Projector Cabinet

Unplug the AC power cord before cleaning.

Gently wipe the projector body with a soft dry cleaning cloth. When the cabinet is heavily soiled, use a small amount of mild detergent and finish with a soft dry cleaning cloth. Avoid using an excessive amount of cleaner. Abrasive cleaners, solvents, or other harsh chemicals might scratch the surface of the cabinet.

When the projector is not in use, put the projector in an appropriate carrying case to protect it from dust and scratches.

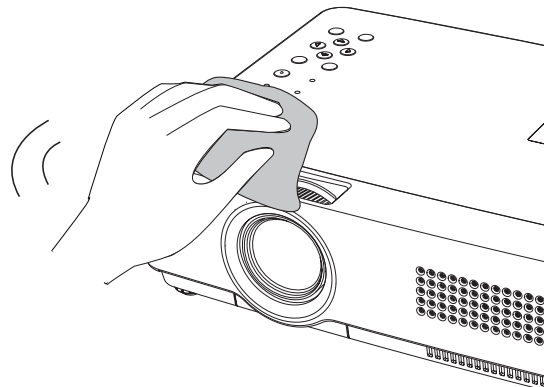
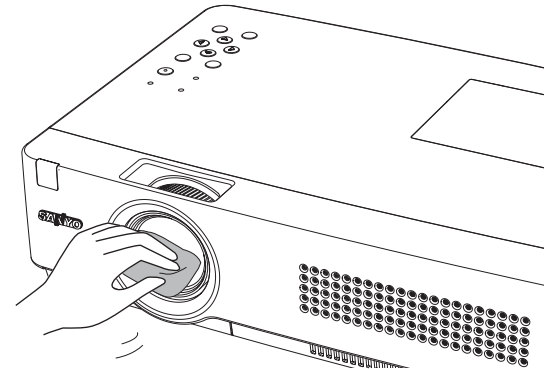

CAUTION

Do not use any flammable solvents or air sprays on the projector and in its vicinity. The explosion or fire hazard may occur even after the AC power cord is unplugged because the temperature inside the projector is extremely high due to the lamps. In addition, there is a risk that the internal parts may be damaged not only by the flammable air spray but also by the cold air.

Maintenance and Cleaning

Lamp Replacement

When the projection lamp of the projector reaches its end of life, the Lamp replacement icon appears on the screen and LAMP REPLACE indicator lights yellow. Replace the lamp with a new one promptly. The timing when the LAMP REPLACE indicator should light is depending on the lamp mode.

Top Control

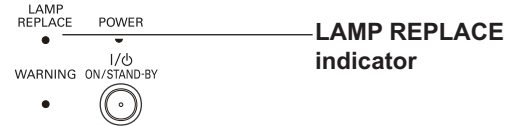

Lamp replacement icon



✓ Note:

- When Mode 2 is selected in the Lamp life control menu, if the projection lamp of the projector reaches its end of life, the lamp replacement icon appears on the screen, and the projector is turned off automatically after 3 minutes.
- The Lamp replacement icon will not appear when the Display function is set to **Off** (p.46), during **Freeze** (p.25), or **No show** (p.26).



CAUTION

Allow a projector to cool for at least 45 minutes before you open the Lamp Cover. The inside of the projector can become very hot.



CAUTION

For continued safety, replace with a lamp of the same type. Do not drop a lamp or touch a glass bulb! The glass can shatter and may cause injury.



CAUTION

When replacing the lamp because it has stopped illuminating, there is a possibility that the lamp may be broken.

If replacing the lamp of a projector which has been installed on the ceiling, you should always assume that the lamp is broken, and you should stand to the side of the lamp cover, not underneath it. Remove the lamp cover gently. Small pieces of glass may fall out when the lamp cover is opened. If pieces of glass get into your eyes or mouth, seek medical advice immediately.

Follow these steps to replace the lamp.

- 1** Unplug the AC power cord. Let the projector cool for at least 45 minutes.
- 2** Loosen the screw and open the lamp cover.
- 3** Loosen the three (3) screws that secure the lamp. Lift the lamp out of the projector by using the handle.
- 4** Replace the lamp with a new one and secure the three (3) screws. Make sure that the lamp is set properly. Close the lamp cover and secure the screw.
- 5** Connect the AC power cord to the projector and turn on the projector.

Lamp Cover

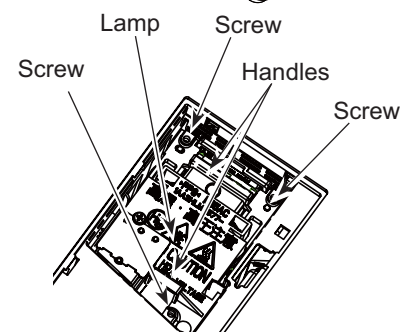
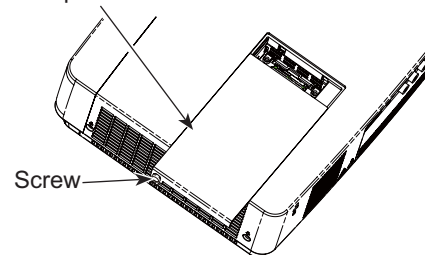

ORDER REPLACEMENT LAMP

Replacement lamp can be ordered through your dealer. When ordering a projection lamp, give the following information to the dealer.

- **Model No. of your projector** : **PLC-XU3001**
- **Replacement Lamp Type No.** : **POA-LMP131**
(Service Parts No. 610 343 2069)



LAMP HANDLING PRECAUTIONS

This projector uses a high-pressure lamp which must be handled carefully and properly. Improper handling may result in accidents, injury, or create a fire hazard.

- Lamp life may differ from lamp to lamp and according to the environment of use. There is no guarantee of the same life for each lamp. Some lamps may fail or terminate their life in a shorter period of time than other similar lamps.
- If the projector indicates that the lamp should be replaced, i.e., if the LAMP REPLACE indicator lights up, replace the lamp with a new one IMMEDIATELY after the projector has cooled down. (Follow carefully the instructions in the Lamp Replacement section of this manual.) Continuous use of the lamp with the LAMP REPLACE indicator lighted may increase the risk of lamp explosion.
- A Lamp may explode as a result of vibration, shock or degradation as a result of hours of use as its lifetime draws to an end. Risk of explosion may differ according to the environment or conditions in which the projector and lamp are being used.

IF A LAMP EXPLODES, THE FOLLOWING SAFETY PRECAUTIONS SHOULD BE TAKEN.

If a lamp explodes, disconnect the projector's AC plug from the AC outlet immediately. Contact an authorized service station for a checkup of the unit and replacement of the lamp. Additionally, check carefully to ensure that there are no broken shards or pieces of glass around the projector or coming out from the cooling air circulation holes. Any broken shards found should be cleaned up carefully. No one should check the inside of the projector except those who are authorized trained technicians and who are familiar with projector service. Inappropriate attempts to service the unit by anyone, especially those who are not appropriately trained to do so, may result in an accident or injury caused by pieces of broken glass.

Appendix

Troubleshooting

Before calling your dealer or service center for assistance, check the items below once again.

- Make sure you have properly connected the projector to peripheral equipment as described on pages 14-16.
- Make sure all equipment is connected to AC outlet and the power is turned on.
- When the projector does not project an image from the connected computer, restart the computer.

Problem:	– Solutions
No power	<ul style="list-style-type: none">– Plug the power cord of the projector into the AC outlet.– See if the POWER indicator lights red.– Wait until the POWER indicator stops blinking to turn on the projector again. The projector can be turned on after the POWER indicator turns red. See page 18.– Check the WARNING indicator. If the WARNING indicator lights red, projector cannot be turned on. See page 59.– Check the projection lamp. See page 62.– Unlock the Key lock function for the projector. See page 54.
The initial display is not shown.	<ul style="list-style-type: none">– Make sure Off or Countdown off are not chosen at display function. See page 46.
The initial display is not same as the default set.	<ul style="list-style-type: none">– Make sure User or Off are not chosen at Logo (select) function. See page 47.
Input signal switches automatically. (or does not switch automatically)	<ul style="list-style-type: none">– Make sure Input search function is adjusted properly. See page 45.
When the projector is on and you press the input button, an icon other than the Lamp mode icon appears.	<ul style="list-style-type: none">– That is the Filter warning icon. See page 56.
An icon other than Input mode or Lamp mode icon appears.	<ul style="list-style-type: none">– That is the Lamp replacement icon or the Filter warning icon. See pages 56 or 62.
Image is out of focus.	<ul style="list-style-type: none">– Adjust focus of the projector. See page 23.– Provide proper distance between the projector and the projection screen. See page 13.– Check the projection lens to see if it needs cleaning. See page 61.– Moving the projector from a cool to warm place may result in moisture condensation on the projection lens. In such cases, leave the projector off and wait until condensation evaporates.
Image is Left/Right reversed. Image is Top/Bottom reversed.	<ul style="list-style-type: none">– Check the Ceiling/Rear function. See page 50.– Check the Ceiling function. See page 50.
Picture is not bright enough.	<ul style="list-style-type: none">– Check if the Contrast or Brightness is adjusted properly. See pages 34,41.– Check if Image mode is selected properly. See pages 33,40.– Check the lamp control function. See pages 25,53.– Check the LAMP REPLACE indicator. If it lights, the end of lamp life is approaching. Replace the lamp with a new one promptly. See page 62.

<p>No image</p>	<ul style="list-style-type: none"> – Check the connection between your computer or video equipment and the projector. See pages 14-16. – See if the input signal is correctly output from your computer. Some laptop computers may need to change the setting for monitor output when connecting to a projector. See your computer's instruction manual for the setting. – It takes about 30 seconds to display an image after turning on the projector. See page 18. – Check the Input signal, color system, video system or computer system mode. – Make sure the temperature is not out of the specified Operating Temperature (41°F–95°F [5°C–35°C]). – When No Show is operating, the image cannot be displayed. Press the NO SHOW button or any other button on the remote control.
<p>No sound</p>	<ul style="list-style-type: none"> – Check the audio cable connection from audio input source. – Adjust the audio source. – Press the Volume + button. See page 24. – Press the Mute button. See page 24. – When the AUDIO OUT is plugged-in, the projector's built-in speaker is not available. – Is the image projected? You will hear the sound only when the image is projected.
<p>The color is strange.</p>	<ul style="list-style-type: none"> – Check the Input signal, color system, video system or computer system mode. – Make sure the Blackboard is not selected on Image select menu. See pages 33,40.
<p>Some displays are not seen during the operation.</p>	<ul style="list-style-type: none"> – Check the Display function. See page 46.
<p>Auto PC adjustment function does not work.</p>	<ul style="list-style-type: none"> – Check the Input signal. Auto PC adjustment function can not work when 480p, 575p, 720p, 480i, 575i, 1035i or 1080i is selected, or when the digital RGB signal is coming from DVI-I terminal. See page 30.
<p>The setting does not remain after turning off power.</p>	<ul style="list-style-type: none"> – Make sure you selected Store after adjusting setting. Some settings can not be stored if not registered with Store. See pages 35,42.
<p>Power management does not work.</p>	<ul style="list-style-type: none"> – Power management function can not work while Freeze or No Show function is running. See page 51.
<p>Capture function does not work.</p>	<ul style="list-style-type: none"> – Check the connection and the input signal to see if there is signal.
<p>Auto setup does not work properly.</p>	<ul style="list-style-type: none"> – Make sure Off is not selected at any function of Auto setup. See page 45. – Make sure On is not selected at the Ceiling function. See page 50.
<p>Auto keystone function does not work even when the projector is tipped.</p>	<ul style="list-style-type: none"> – Make sure the Auto keystone function is not set to Manual. Press the AUTO SETUP button on the top control. See pages 23,45.

Appendix

The image is distorted or runs off.	– Check PC adjust menu or Screen menu and adjust them. See pages 31-32, 35-36.
PIN code dialog box appears at start-up.	– PIN code lock is being set. Enter a PIN code (the “1234” or numbers you have set). See pages 19, 54-55.
The Remote Control does not work.	– Check the batteries. – Make sure no obstruction is between the projector and remote control. – Make sure you are not too far from the projector when using the remote control. Maximum operating range is 16.4'(5 m). – Make sure the code of the remote control is conformed to the projector's code. See page 53. – Unlock the Key lock function for the remote control function. See page 54.
Indicator blinks or lights.	– Check the status of the projector with referring to "Indicators and projector Condition". See page 70.
The exclamation mark appears on the screen.	– Your operation is invalid. Operate correctly.
Top control does not work.	– The top control is not available if the top control is locked at Key lock under Security of SETTING section. See page 54.
Unable to unlock the Logo PIN code lock, Security key lock or Security PIN code lock.	– Contact the dealer where you purchased the projector or the service center.

WARNING :

High voltages are used to operate this projector. Do not attempt to open the cabinet.

If problems still persist after following all operating instructions, contact the dealer where you purchased the projector or the service center. Specify the model number and explain about the problem. We will advise you how to obtain service.



The CE Mark is a Directive conformity mark of the European Community (EC).



Pixelworks ICs used.

Licensed under USP5,717,422 USP6,816,141



This symbol on the nameplate means the product is Listed by Underwriters Laboratories Inc. It is designed and manufactured to meet rigid U.L. safety standards against risk of fire, casualty and electrical hazards.

Menu Tree

Computer Input/Video Input

Input

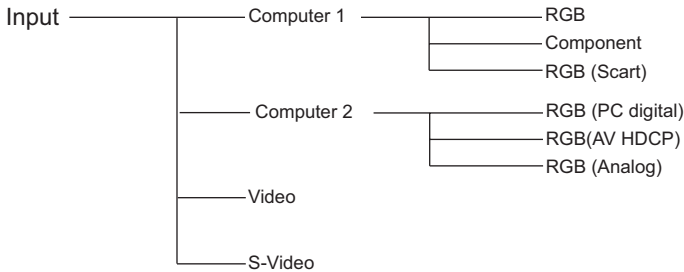

Sound



Computer Input

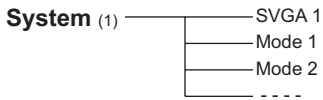

* Systems displayed in the System Menu vary depending on an input signal.

Image select

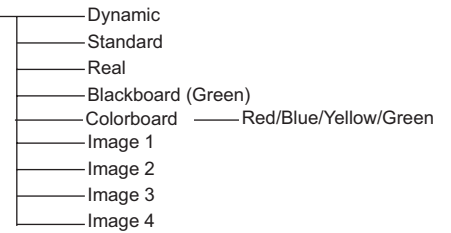

PC adjust

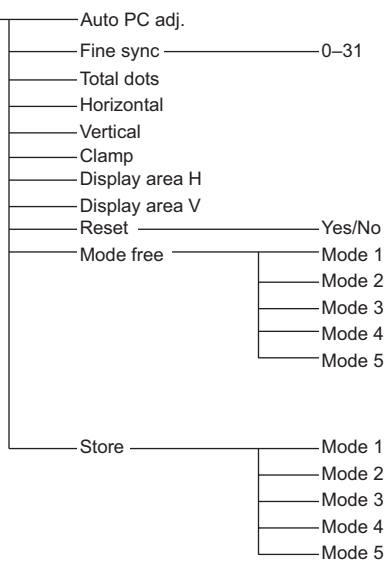
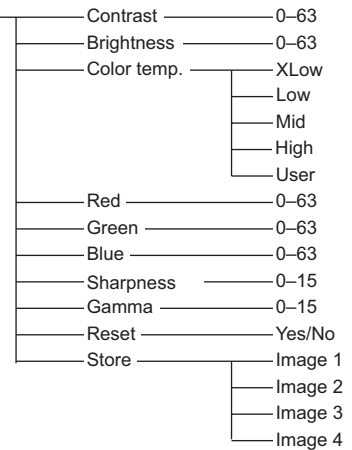
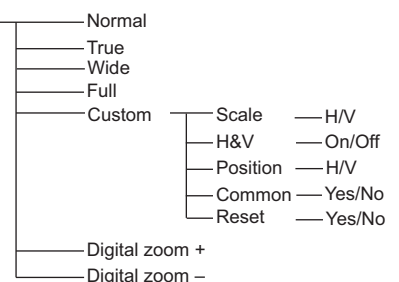

Image Adjust



Screen



Video Input

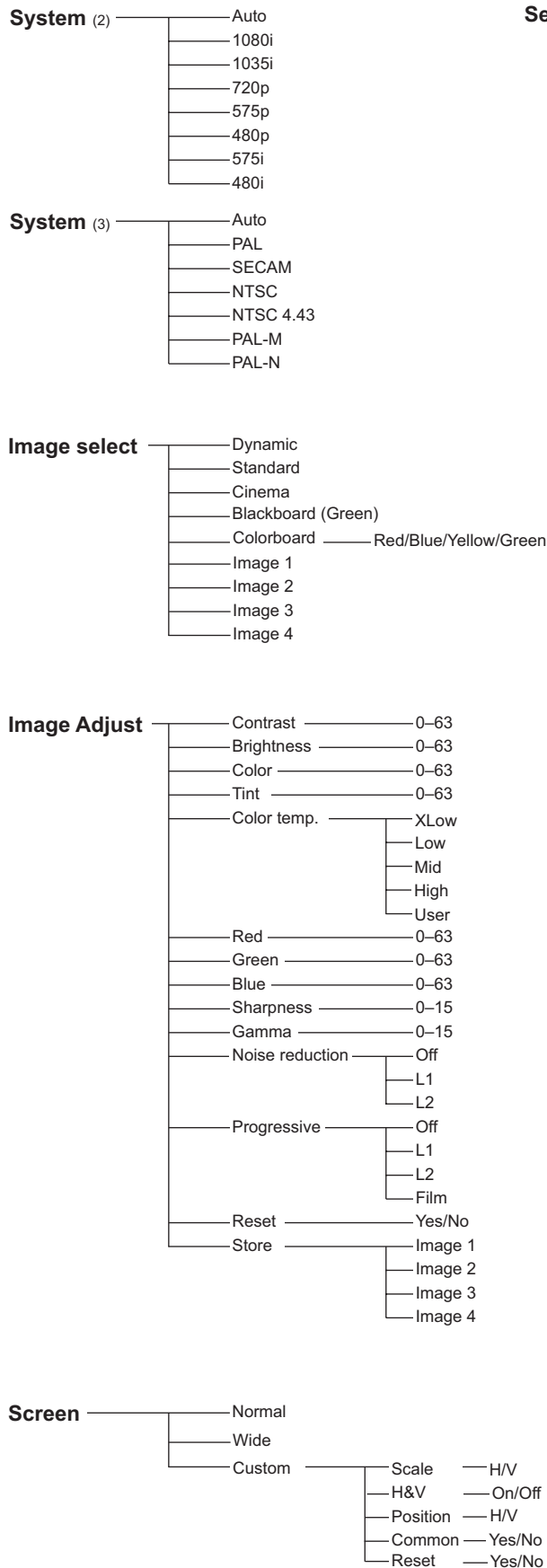

Setting

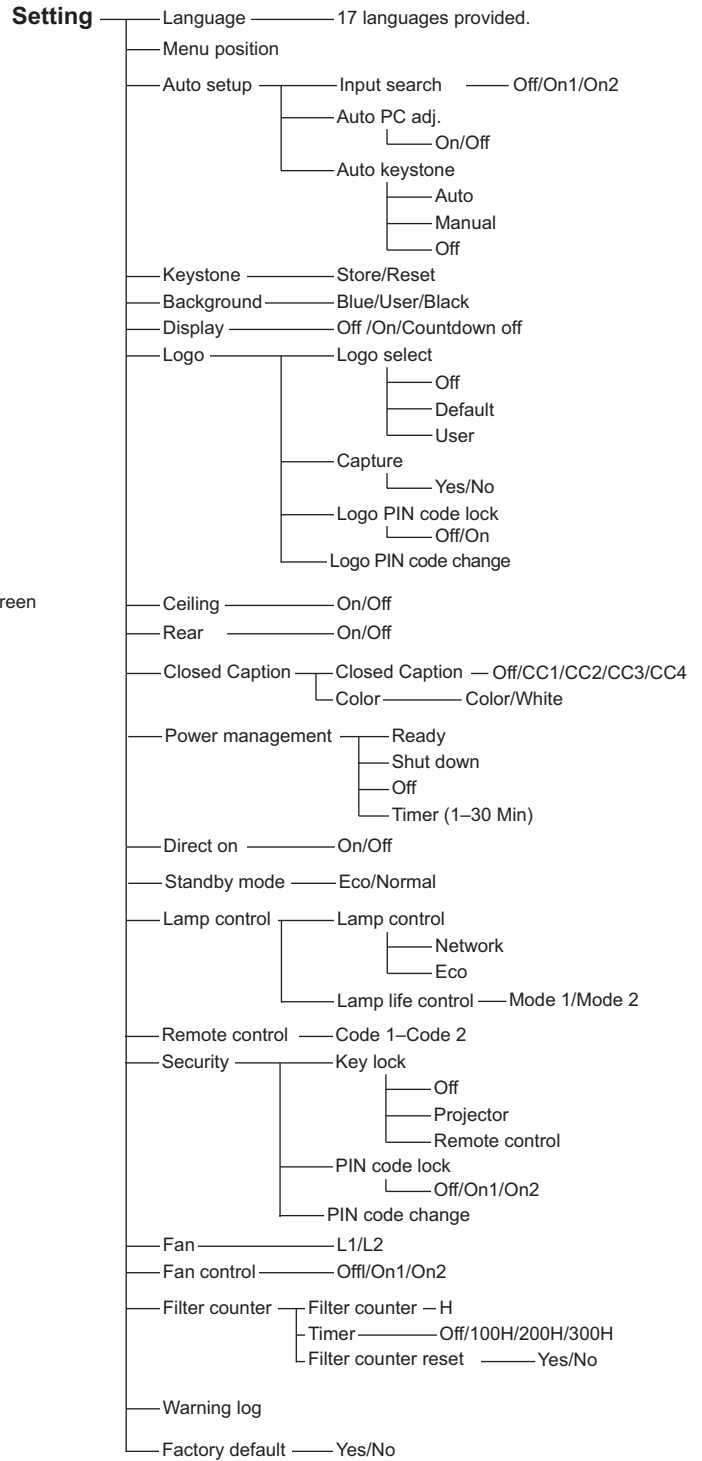

Information — Input Source Information Display

Indicators and Projector Condition

Check the indicators for projector condition.

Indicators			Projector Condition
POWER red/green	WARNING red	LAMP REPLACE yellow	
●	●	●	The projector is off. (The AC power cord is unplugged.)
◐	●	*	The projector is in stand-by mode. Press the ON/STAND-BY button to turn on the projector.
○	●	*	The projector is operating normally.
◐	●	*	The projector is preparing for stand-by or the projection lamp is being cooled down. The projector cannot be turned on until cooling is completed and the POWER indicator stops blinking.
◐	●	*	The projector is in the Power management mode.
◐	◐	*	The temperature inside the projector is abnormally high. The projector cannot be turned on. When the projector is cooled down enough and the temperature returns to normal, the POWER indicator stops blinking and the projector can be turned on. (The WARNING indicator keeps blinking.)
◐	◐	*	The projector has been cooled down enough and the temperature returns to normal. When turning on the projector, the WARNING indicator stops blinking.
●	◐	*	The projector detects an abnormal condition and cannot be turned on. Unplug the AC power cord and plug it again to turn on the projector. If the projector is turned off again, unplug the AC power cord and contact the dealer or the service center for service and checkup. Do not leave the projector on. It may cause an electric shock or a fire hazard.

○ ••• green.

◐ ••• red

● ••• off

◐ ••• blinks green.

◐ ••• blinks red.

* When the projection lamp reaches its end of life, the LAMP REPLACE indicator lights yellow. When this indicator lights yellow, replace the projection lamp with a new one promptly.

Compatible Computer Specifications

Basically this projector can accept the signal from all computers with the V-, H-Frequency mentioned below and less than 140 MHz of Dot Clock.

When selecting these modes, PC adjustment can be limited.

ON-SCREEN DISPLAY	RESOLUTION	H-Freq. (KHz)	V-Freq. (Hz)	ON-SCREEN DISPLAY	RESOLUTION	H-Freq. (KHz)	V-Freq. (Hz)
VGA 1	640 x 480	31.47	59.88	SXGA 5	1280 x 1024	63.74	60.01
VGA 2	720 x 400	31.47	70.09	SXGA 6	1280 x 1024	71.69	67.19
VGA 3	640 x 400	31.47	70.09	SXGA 7	1280 x 1024	81.13	76.107
VGA 4	640 x 480	37.86	74.38	SXGA 8	1280 x 1024	63.98	60.02
VGA 5	640 x 480	37.86	72.81	SXGA 9	1280 x 1024	79.976	75.025
VGA 6	640 x 480	37.50	75.00	SXGA 10	1280 x 960	60.00	60.00
VGA 7	640 x 480	43.269	85.00	SXGA 11	1152 x 900	61.20	65.20
MAC LC13	640 x 480	34.97	66.60	SXGA 12	1152 x 900	71.40	75.60
MAC 13	640 x 480	35.00	66.67	SXGA 13	1280 x 1024	50.00	86.00 (Interface)
480p	640 x 480	31.47	59.88	SXGA 14	1280 x 1024	50.00	94.00 (Interface)
575p	768 x 575	31.25	50.00	SXGA 15	1280 x 1024	63.37	60.01
480i	640 x 480	15.734	60.00 (Interface)	SXGA 16	1280 x 1024	76.97	72.00
575i	768 x 576	15.625	50.00 (Interface)	SXGA 17	1152 x 900	61.85	66.00
SVGA 1	800 x 600	35.156	56.25	SXGA 18	1280 x 1024	46.43	86.70 (Interface)
SVGA 2	800 x 600	37.88	60.32	SXGA 19	1280 x 1024	63.79	60.18
SVGA 3	800 x 600	46.875	75.00	SXGA 20	1280 x 1024	91.146	85.024
SVGA 4	800 x 600	53.674	85.06	SXGA+ 1	1400 x 1050	63.97	60.19
SVGA 5	800 x 600	48.08	72.19	SXGA+ 2	1400 x 1050	65.35	60.12
SVGA 6	800 x 600	37.90	61.03	SXGA+ 3	1400 x 1050	65.12	59.90
SVGA 7	800 x 600	34.50	55.38	MAC21	1152 x 870	68.68	75.06
SVGA 8	800 x 600	38.00	60.51	MAC	1280 x 960	75.00	75.08
SVGA 9	800 x 600	38.60	60.31	MAC	1280 x 1024	80.00	75.08
SVGA 10	800 x 600	32.70	51.09	WXGA 1	1366 x 768	48.36	60.00
SVGA 11	800 x 600	38.00	60.51	WXGA 2	1360 x 768	47.70	60.00
MAC 16	832 x 624	49.72	74.55	WXGA 3	1376 x 768	48.36	60.00
MAC 19	1024 x 768	60.24	75.08	WXGA 4	1360 x 768	56.16	72.00
XGA 1	1024 x 768	48.36	60.00	WXGA 6	1280 x 768	47.776	59.87
XGA 2	1024 x 768	68.677	84.997	WXGA 7	1280 x 768	60.289	74.893
XGA 3	1024 x 768	60.023	75.03	WXGA 8	1280 x 768	68.633	84.837
XGA 4	1024 x 768	56.476	70.07	WXGA 9	1280 x 800	49.600	60.050
XGA 5	1024 x 768	60.31	74.92	WXGA 10	1280 x 800	41.200	50.000
XGA 6	1024 x 768	48.50	60.02	WXGA 11	1280 x 800	49.702	59.810
XGA 7	1024 x 768	44.00	54.58	WXGA 12	1280 x 800	63.98	60.02
XGA 8	1024 x 768	63.48	79.35	WUXGA 1	1920 x 1200	74.556	59.885
XGA 9	1024 x 768	36.00	87.17 (Interface)	WUXGA 2	1920 x 1200	74.038	59.950
XGA 10	1024 x 768	62.04	77.07	WSXGA+ 1	1680 x 1050	65.290	59.954
XGA 11	1024 x 768	61.00	75.70	WXGA+ 1	1440 x 900	55.935	59.887
XGA 12	1024 x 768	35.522	86.96 (Interface)	WXGA+ 2	1440 x 900	74.918	60.000
XGA 13	1024 x 768	46.90	58.20	UXGA 1	1600 x 1200	75.00	60.00
XGA 14	1024 x 768	47.00	58.30	UXGA 2	1600 x 1200	81.25	65.00
XGA 15	1024 x 768	58.03	72.00	UXGA 3	1600 x 1200	87.5	70.00
SXGA 1	1152 x 864	64.20	70.40	UXGA 4	1600 x 1200	93.75	75.00
SXGA 2	1280 x 1024	62.50	58.60	720p	1280 x 720	45.00	60.00
SXGA 3	1280 x 1024	63.90	60.00	720p	1280 x 720	37.50	50.00
SXGA 4	1280 x 1024	63.34	59.98	1035i	1920 x 1035	33.75	60.00 (Interface)
				1080i	1920 x 1080	33.75	60.00 (Interface)
				1080i	1920 x 1080	28.125	50.00 (Interface)

Appendix

When the input signal is digital from DVI terminal, refer to the chart below.

ON-SCREEN DISPLAY	RESOLUTION	H-Freq. (KHz)	V-Freq. (Hz)	ON-SCREEN DISPLAY	RESOLUTION	H-Freq. (KHz)	V-Freq. (Hz)
D-VGA	640 x 480	31.47	59.94	D-SXGA1	1280 x 1024	63.98	60.02
D-480p	640 x 480	31.47	59.88	D-SXGA2	1280 x 1024	60.276	58.069
D-575p	768 x 575	31.25	50.00	D-SXGA3	1280 x 1024	31.65	29.80
D-SVGA	800 x 600	37.879	60.32	D-720p	1280 x 720	37.50	50.00
D-XGA	1024 x 768	43.363	60.00	D-720p	1280 x 720	45.00	60.00
D-WXGA 1	1366 x 768	48.36	60.00	D-1035i	1920 x 1035	33.75	60.00 (Interface)
D-WXGA 2	1360 x 768	47.7	60.00	D-1080i	1920 x 1080	33.75	60.00 (Interface)
D-WXGA 3	1376 x 768	48.36	60.00	D-1080i	1920 x 1080	28.125	50.00 (Interface)
D-WXGA 4	1360 x 768	56.160	72.000	D-WXGA +1	1440 x 900	55.935	59.887
D-WXGA 5	1366 x 768	46.500	50.000	D-SXGA+ 1	1400 x 1050	63.97	60.19
D-WXGA 6	1280 x 768	47.776	59.870	D-SXGA+ 2	1400 x 1050	65.350	60.120
D-WXGA 7	1280 x 768	60.289	74.893	D-SXGA+ 3	1400 x 1050	65.120	59.900
D-WXGA 8	1280 x 768	68.633	84.837	D-WSXGA+1	1680 x 1050	65.290	59.954
D-WXGA 9	1280 x 800	49.572	59.870	D-WUXGA 2	1920 x 1200	74.038	59.950
D-WXGA 10	1280 x 800	41.200	50.000				
D-WXGA 11	1280 x 800	49.702	59.810				
D-WXGA 12	1280 x 800	63.98	60.02				

✓ **Note:**

The specifications are subject to change without notice.

Technical Specifications

Mechanical Information

Projector Type	Multi-media Projector
Dimensions (W x H x D)	12.80" x 3.27" x 9.12" (326mm x 83.1mm x 231.6mm) (Not including protrusions)
Net Weight	5.7 lbs (2.6 kg)
Feet Adjustment	0° to 12°

Panel Resolution

LCD Panel System	0.63" TFT Active Matrix type, 3 panels
Panel Resolution	1,024 x 768 dots
Number of Pixels	2,359,296 (1,024 x 768 x 3 panels)

Signal Compatibility

Color System	PAL, SECAM, NTSC, NTSC4.43, PAL-M, and PAL-N
SD/HD Signal	480i, 480p, 575i, 575p, 720p, 1035i, and 1080i
Scanning Frequency	H-sync. 15 kHz–100 kHz, V-sync. 50–100 Hz

Optical Information

Projection Image Size (Diagonal)	Adjustable from 40" to 300"
Throw Distance	4.6' ~ 41.7' (1.4 m ~ 12.7 m)
Projection Lens	F 1.60 ~ 1.76 lens with f 22.3 mm ~ 26.8 mm with manual zoom and focus
Projection Lamp	225 W

Interface

Video Input Jack	RCA Type x 1
S-video Input Jack	Mini DIN 4 pin x 1
Audio Input Jacks	RCA Type x 2
Computer 1 /Computer2 Audio Input Jacks	Mini Jack x 2
Computer In 1/ Component Input Terminal	Mini D-sub 15 pin x 1
Computer In 2/DVI-I Input	DVI-I Terminal x 1
Monitor Output Terminal	Mini D-sub 15 pin x 1
Control port	D-sub 9 pin x 1
Audio Output Jack	Mini Jack (stereo) x 1 (variable)
LAN Connection Terminal	RJ-45

Audio

Internal Audio Amp	7.0 W RMS
Built-in Speaker	1 speaker, ø1.46" (37mm)

Power

Voltage and Power Consumption	AC 100–120 V (3.7A Max.), 50/60 Hz (The U.S.A and Canada) AC 200–240 V (2.0A Max.), 50/60 Hz (Continental Europe and The U.K.)
-------------------------------	---

Operating Environment

Operating Temperature	41°F–95°F (5 °C–35 °C)
Storage Temperature	14°F–140°F (-10°C–60 °C)

Remote Control

Battery	AAA or LR03 1.5V ALKALINE TYPE x 2
Operating Range	16.4' (5 m)/±30°
Dimensions	2.0" (W) x 0.7" (H) x 4.3" (D) (52 mm x 18 mm x 110 mm)
Net Weight	2.37 oz (67 g) (including batteries)

Accessories

Owner's Manual (CD-ROM)
Quick Reference Guide
AC Power Cord
Remote Control and Batteries
VGA Cable
Lens Cap with String
PIN Code Label
Soft Carrying Case

- The specifications are subject to change without notice.
- LCD panels are manufactured to the highest possible standards. Even though 99.99% of the pixels are effective, a tiny fraction of the pixels (0.01% or less) may be ineffective by the characteristics of the LCD panels.

Optional Parts

The parts listed below are optionally available. When ordering those parts, specify the item name and Model No. to the sales dealer.

	Model No.
COMPONENT~VGA Cable	: POA-CA-COMPVGA
SCART~VGA Cable	: POA-CA-SCART
VGA-Cable (10 m)	: KA-MC-DB10

PJ Link Notice

This projector is compliant with PJLink Standard Class 1 of JBMIA (Japan Business Machine and Information System Industries Association). This projector supports all commands defined by PJLink Class 1 and is verified conformance with PJLink Standard Class 1.

For PJ Link password, see the owner's manual of "Network Set-up and Operation."

Projector Input	PJLink Input	Parameter	
Computer 2	RGB (Analog)	RGB 3	13
	RGB (PC digital)	DIGITAL 1	31
	RGB (AV HDCP)	DIGITAL 2	32
Computer 1	RGB	RGB 1	11
	Component	VIDEO 2	22
	RGB (Scart)	RGB 2	12
Video	Video	VIDEO 1	21
	S-video	VIDEO 5	25

PJLink is a registered trademark of JBMIA and pending trademark in some countries.



Configurations of Terminals

COMPUTER IN 1 /COMPONENT IN /MONITOR OUT (ANALOG)

Terminal: Analog RGB (Mini D-sub 15 pin)

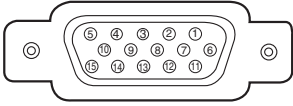

1	Red (R/Cr) Input/Output	9	+5V Power/-----
2	Green (G/Y) Input/Output	10	Ground (Vert.sync.)
3	Blue (B/Cb) Input/Output	11	Ground/-----
4	-----	12	DDC Data/-----
5	Ground (Horiz.sync.)	13	Horiz. sync. Input/Output (Composite H/V sync.)
6	Ground (Red)	14	Vert. sync.
7	Ground (Green)	15	DDC Clock/-----
8	Ground (Blue)		

COMPUTER IN 2 / DVI-I TERMINAL (DIGITAL/ANALOG)

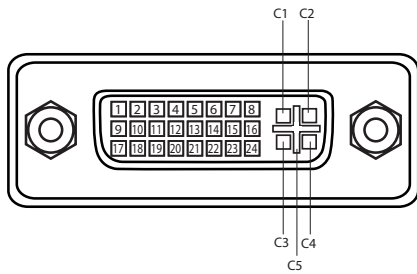

C1	Analog Red Input
C2	Analog Green Input
C3	Analog Blue Input
C4	Analog Horiz. sync
C5	Analog Ground (R/G/B)

1	T.M.D.S. Data2-	9	T.M.D.S. Data1-	17	T.M.D.S. Data0-
2	T.M.D.S. Data2+	10	T.M.D.S. Data1+	18	T.M.D.S. Data0+
3	T.M.D.S. Data2 Shield	11	T.M.D.S. Data1 Shield	19	T.M.D.S. Data0 Shield
4	No Connect	12	No Connect	20	No Connect
5	No Connect	13	No Connect	21	No Connect
6	DDC Clock	14	+5V Power	22	T.M.D.S. Clock Shield
7	DDC Data	15	Ground (for +5V)	23	T.M.D.S. Clock+
8	Analog Vert. sync	16	Hot Plug Detect	24	T.M.D.S. Clock-

CONTROL PORT CONNECTOR (D-sub 9 pin)

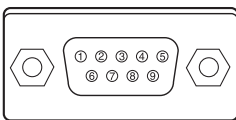

	Serial
1	-----
2	R X D
3	T X D
4	-----
5	SG
6	-----
7	-----
8	-----
9	-----

LAN TERMINAL

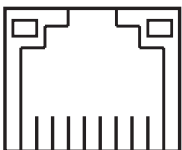

87654321

1	TX +	5	-----
2	TX -	6	RX -
3	RX +	7	-----
4	-----	8	-----

PIN Code Number Memo

Write down the PIN code number in the column below and keep it with this manual securely. If you forgot or lost the number and unable to operate the projector, contact the service station.

PIN Code Lock No.	<table border="1"> <tr> <td style="width: 25px; height: 40px;"></td> <td style="width: 25px; height: 40px;"></td> <td style="width: 25px; height: 40px;"></td> <td style="width: 25px; height: 40px;"></td> </tr> </table>				
	Factory default set No: 1 2 3 4*				
Logo PIN Code Lock No.	<table border="1"> <tr> <td style="width: 25px; height: 40px;"></td> <td style="width: 25px; height: 40px;"></td> <td style="width: 25px; height: 40px;"></td> <td style="width: 25px; height: 40px;"></td> </tr> </table>				
	Factory default set No: 4 3 2 1*				

*Should the four-digit number be changed, the factory set number will be invalid.

While the projector is locked with the PIN code.

Put the label below (supplied) on in a prominent place of the projector's body while it is locked with a PIN code.

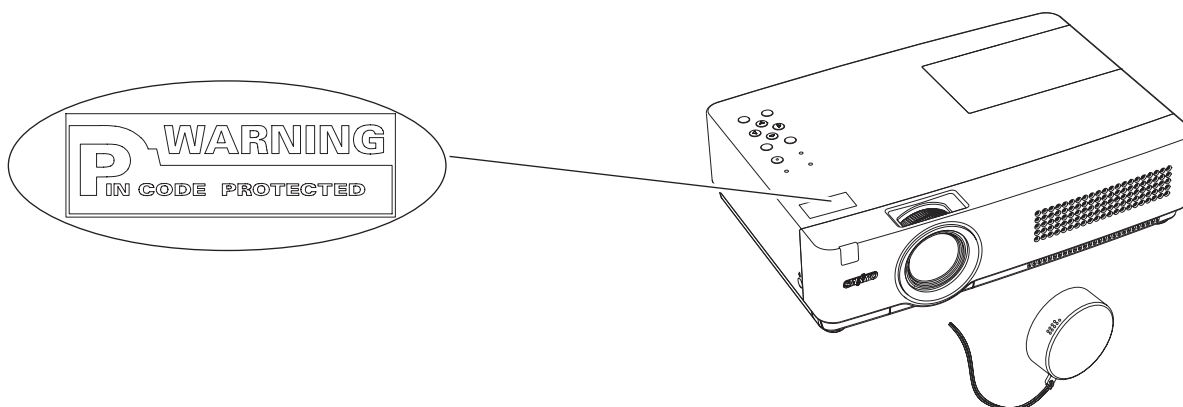

Appendix

Dimensions

Unit: mm(inch)

↘ Screw Holes for Ceiling Mount
Screw: M4
Depth: 12.0(0.472)

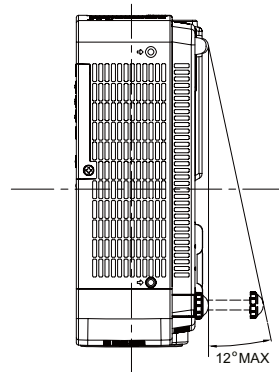
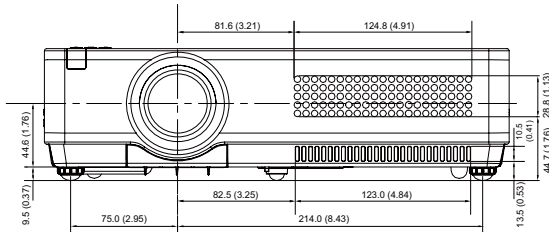
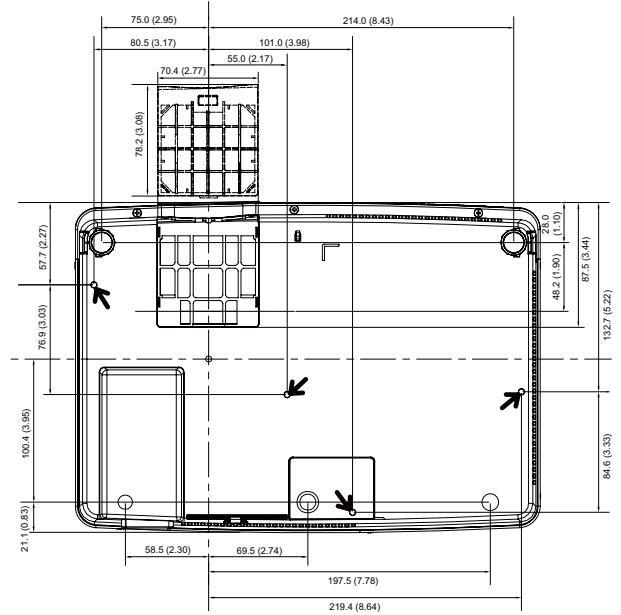
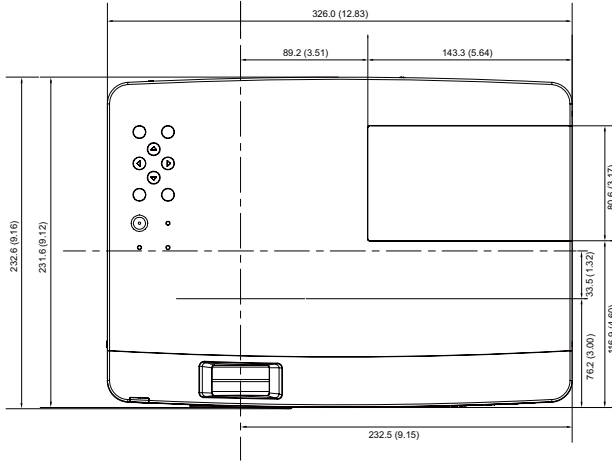



Owner's Manual

Network Set-up and Operation

Wired Setting

Projector Set-up and Operation

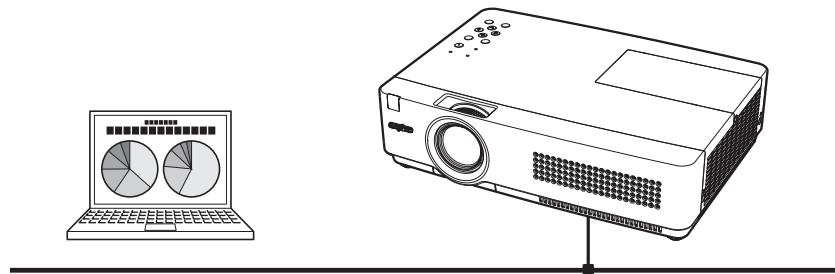

This is the manual for the Network function.
Read this manual thoroughly to operate the Network function.
First, read the owner's manual of the projector to understand the basic operation of the projector and the safety instructions.
The safety instructions in the owner's manuals should be followed strictly.

Compliance

Federal Communications Commission Notice

This equipment has been tested and found to comply with the limits for a Class B digital device, pursuant to part 15 of the FCC Rules. These limits are designed to provide reasonable protection against harmful interference in a residential installation. This equipment generates, uses and can radiate radio frequency energy and, if not installed and used in accordance with the instructions, may cause harmful interference to radio communications. However, there is no guarantee that interference will not occur in a particular installation. If this equipment causes harmful interference to radio or television reception which can be determined by turning the equipment off and on, the user is encouraged to try to correct the interference by one or more of the following measures:

- Reorient or relocate the receiving antenna.
- Increase the separation between the equipment and receiver.
- Connect the equipment into an outlet on a circuit different from that to which the receiver is connected.
- Consult the dealer or an experienced radio/TV technician for help.

Use of shielded cable is required to comply with class B limits in Subpart B of Part 15 of FCC Rules.

Do not make any changes or modifications to the equipment unless otherwise specified in the instructions. If such changes or modifications should be made, you could be required to stop operation of the equipment.

Model Numbers	: PLC-XU3001
Trade Name	: Sanyo
Responsible party	: SANYO NORTH AMERICA CORPORATION
Address	: 21605 Plummer Street, Chatsworth, California 91311
Telephone No.	: (818)998-7322

Safety instructions



CAUTION IN USING THE PROJECTOR VIA NETWORKS

- When you find a problem with the projector, remove the power cable immediately and inspect the unit. Using the projector with failure may cause fire or other accidents.
- If you remotely use the projector via networks, carry out a safety check regularly and take particular care to its environment. Incorrect installation may cause fire or other accidents.



CAUTION IN USING NETWORK FUNCTION

- We assume no responsibility for the loss or damage of data, or damage of the computer caused by using this projector. Making back-up copies of valuable data in your computer is recommended.

Table of contents

Compliance.....	2
Safety instructions.....	3
Table of contents.....	4
Chapter 1 Preparation	5
Features.....	6
Required operating environment for computers.....	7
Network specifications of the projector.....	7
Flow of installation.....	9
Chapter 2 Setup Procedures.....	11
Connecting to the LAN line.....	12
Network configuration.....	12
Network PIN code.....	14
Network information.....	14
Network factory default.....	15
Wired LAN factory default settings.....	16
Chapter 3 Basic Setting and Operation	17
Login the setting page of the projector.....	18
[1] Enter the IP address.....	18
[2] Login.....	18
[3] Display of main setting page.....	19
How to use the setting page.....	20
Initial setting.....	22
Network PIN code setting.....	23
PJLink and password setting.....	23
Network configuration.....	24
E-mail setting.....	25
Examples: Type and contents of alert mail.....	27
SNMP setting.....	29
Chapter 4 Controlling the Projector	31
Power control and status check.....	32
Control.....	34
Input.....	34
System.....	35
Sound.....	36
Image adjustment.....	37
PC adjustment.....	38
Setting up the projector.....	39
Screen setting.....	39
Setting 1.....	40
Setting 2.....	40
Setting 3.....	41
Information.....	42
Chapter 5 Appendix	43
Examples of connection.....	44
Use of telnet.....	46
Web browser setting.....	48
Examples: OS/Browsers.....	49
Q&A.....	53

Chapter 1

Preparation



Describes features and operating environment of this projector.

Features

Web Management function (p.31)

With this function, you can monitor projector functions such as power status, lamp status, input mode, signal condition, lamp-use time, etc. through the network by using the web browser installed on your computer.

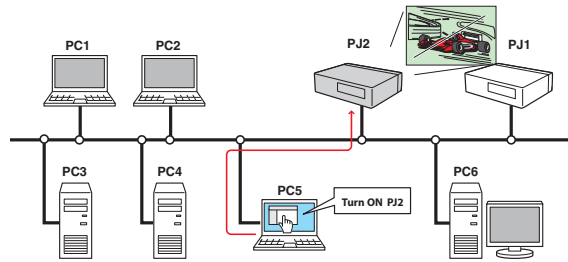

E-Mail Alert function (p.25)

The projector sends messages to the registered e-mail addresses when a lamp abnormality or power failure occurs with the projector. This message describes how to solve the cause of the problems. You can take efficient action for quick recovery.

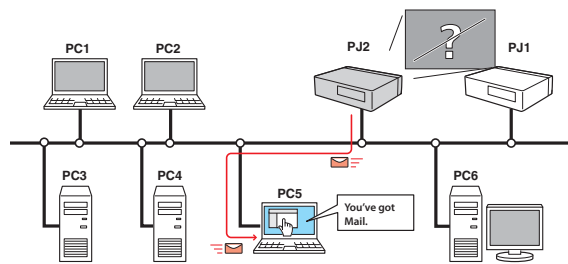

Required operating environment for computers

When operating the projector via networks, computers should meet the operating environment below.

Operating System		Windows XP (32bit version), Windows Vista (32bit version), Windows 7 (32bit version) Mac OS X v 10.4 or 10.5
Computer environment	Recommended CPU	Windows: Pentium III 900MHz or more Macintosh : 800 MHz PowerPC G4 or faster, or 1.8 GHz Intel Core Processor or faster
	Memory	Windows : 64MB (Minimum)/ 128MB or more (Recommended) 128MB or more for Windows XP 1GB or more for Windows Vista or Windows 7 Macintosh : 256MB or more (512MB is recommended)
	Free disk space	100MB or more
	Drive equipment	CD-ROM drive
	Display settings	Support one of following resolutions; VGA (640 x 480), SVGA (800 x 600), XGA (1,024 x 768) Number of colors: Either of 16 bit (65,536 color 24/32 bit (16.77 million colors))
	Network card	The computer must provide a 10Base-T or 100Base-TX network card.
Web Browser*		Internet Explorer version 6.0, 7.0 or 8.0 Netscape Navigator version 7.1 or 9.0 Safari 3.1 * Used to control and set up the projector. The layout of pages in the browser may slightly differ from each type of application or operating system you use.
Recommended Internet Mailer*		- Microsoft Outlook - Microsoft Outlook Express - Netscape Mail * Required the internet e-mail application software to receive an e-mail alert sent from this projector. If you do not use the function E-mail Alert, this application is not required.

Network specifications of the projector

LAN Terminal

Data communication standards	10/100/1000Base-T compatible
Physical layer	10Base-T
Protocol	TCP/IP

Cabling Between the Projector and a Hub or computer*1

Use an appropriate cable when connecting the projector and a hub or computer.

Connection	Ethernet cable type	Max. cable length
Projector - Hub	STP straight-through category 5 *2 cable	100m (328feet)
Projector - Computer	STP crossover category 5*2 cable	100m (328feet)

*1 There may be other limitations depending on your network environment or LAN specification. Please consult your network administrator for further details.

*2 Cable category indicates cable quality.

Notice

Expression/Abbreviation

The OS of the computer and the Web browser described in this manual are Windows XP Professional and Internet Explorer 6.0. In case of another OS or Web browser, some instruction procedures may differ from the actual operation depending on your computer environment.

Use of this manual

This manual does not provide the detailed description of basic operation and functions for computer, web browser, projector and network. For instructions about each piece of equipment or application software, please refer to the respective manual.

Trademarks

Ethernet is a registered trademark of Xerox Corporation. Microsoft, Windows, Windows XP, Windows Vista and Windows 7 are registered trademarks of Microsoft Corporation in the United States and other countries. Internet Explorer is a registered trademark of Microsoft Corporation. Netscape Navigator and Netscape Communicator are trademarks or registered trademarks of Netscape Communications Corporation. JavaScript is a registered trademark of Sun Microsystems, Inc.

Macintosh is a registered trademark of Apple, Inc. in the USA and other countries. PowerPC is a registered trademark of IBM Corporation. Intel Core is a registered trademark of Intel Corporation in the USA and other countries.

Other product or brand names in this manual are registered trademarks or trademarks of their respective owners.

* Unauthorized use of a part or whole of the contents in this manual is prohibited.

* The contents of this manual are subject to change without notice.

Flow of installation

To use the projector via the networks, follow the setup procedures below.

STEP 1 **Connect the LAN and set the configuration.**



Decide depending on the LAN environment.

→ "2. Setup Procedures" (pp.11–16).

Detailed LAN configurations need to be done with a browser later.

First, complete the Wired LAN connection between computers and projectors, then start browser configurations.

→ "3. Basic setting and operation" (pp.17–30).

STEP 2 **Network Configuration has completed.**

Follow each chapter to operate the projector.

■ Operate and manage the projector → "4. Controlling the projector" (pp.31-42)

→ "Power Control and status check" (p.32)

→ "Control" (p.34)

→ "PC adjustment" (p.38)

→ "Setting up the projector" (p.39)

→ "Projector information" (p.42)

Chapter 2 *Setup Procedures*

Describes how to configure the network.



Setting procedures and contents differ depending on the LAN installation location. When installing, consult your system administrator to set up the LAN appropriately.

Connecting to the LAN line

Connect the LAN cable to the LAN connection terminal of the projector.

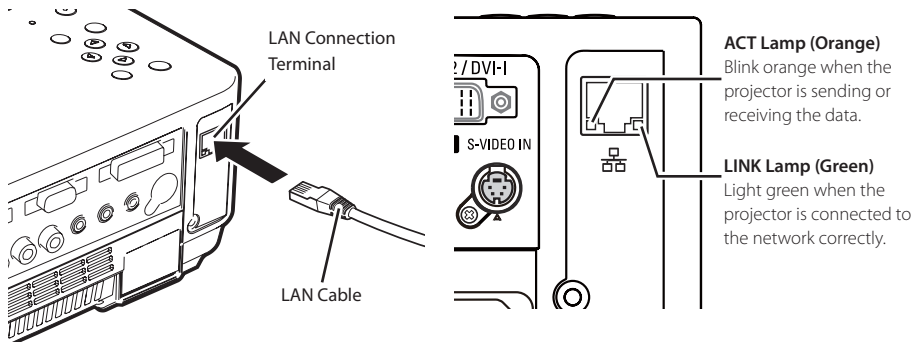

* Please use a shielded LAN cable.

Network configuration

Set the Wired LAN network through the projector menu. Detailed network settings will be made with browser. Refer to "3. Basic setting and operation" (p.17-30). First, complete the settings described in this chapter before performing steps in "3. Basic setting and operation."

Setting Procedure

1. Select "LAN mode select" in the Network menu, and press Point **▶** or **SELECT** button.
2. Select similar LAN environment among LAN1, LAN2 and LAN3 with the Point **▲▼** buttons, and press **SELECT** button. Then the Menu will disappear, the "Please wait..." message will appear, and switching operation will start. Switching will take a while and the projector's LINK/ACT Lamp will be on or blink, and after completing the operation, the "Please wait..." message will disappear.



3. Select "Network setting" in the Network menu and press **SELECT** button, and then the LAN setting screen will appear and selected LAN settings will be displayed. Adjust each item to the setting environment. Consult your system administrator about the detailed settings.

Press **SELECT** button in a row where you want to adjust, and adjust the figures with the Point ▲▼ buttons and move among the items with the Point ◀▶ buttons, and then press **SELECT** button to fix. Move to the next row with the Point ▲▼ buttons to adjust.

4. After completing all the settings, select "Set" and press **SELECT** button. Now, all procedures have been done. To cancel the adjusted settings, select "Cancel" and press **SELECT** button.

You can confirm the LAN settings you have made from "Network information" (p.14). In such cases that the LAN cannot be connected, see this screen.



DHCP: On

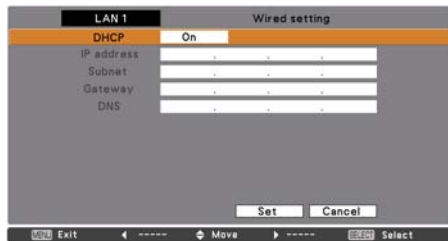

DHCP: Off

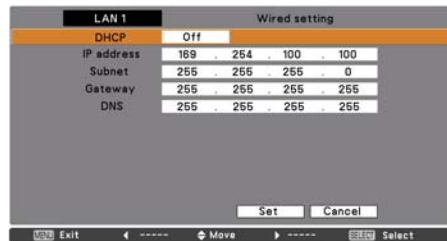

* The numerical value is a setting example.

Item	Description
DHCP	Sets DHCP function On or Off. When you setup the network setting manually, select "Off". When it is set On, IP address, Subnet, Gateway and DNS are automatically set according to your network environment *1.
IP address	Sets IP address of the projector.
Subnet	Sets Subnet mask according to your network environment.
Gateway*2	Sets IP address of the default gateway (Router).
DNS*3	Sets IP address of the DNS server.

*1 Set "On" only when the DHCP server is available on your network environment.

*2 Set [255.255.255.255] if the network does not provide the gateway (router).

*3 Set [255.255.255.255] if you do not use the function E-mail alert.

Network PIN code

The Network PIN code is to restrict the access to the projector through the network. After setting the Network PIN code, you need to enter it to operate the projector via the networks.

1. Select "Network PIN code" in the Network menu, and press **SELECT** button.
The Network PIN code screen will appear.
2. Set the Network PIN code.

Set the figures with the Point ▲▼ buttons and move to the next items with the Point ◀▶ buttons. Select "Set" and press **SELECT** button to set. To cancel the preset Network PIN code, select "Cancel". When you do not want to set the Network PIN code, set "0000".

It is recommended to set the Network PIN code if you use the projector via the networks. The Network PIN code can be set also through the networks. See "3. Basic setting and operation" → "Initial setting" → "Network PIN code setting" (p.23).

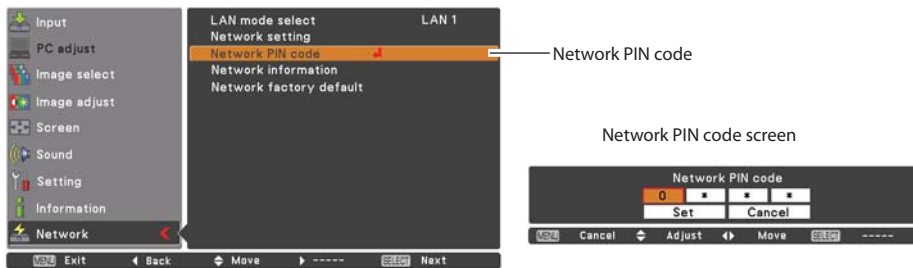

Network information

Select "Network information" in the Network menu and press Point ▶ or **SELECT** button to show LAN setting environment of the currently selected projector. (The description below is an example and different from what will be shown.)

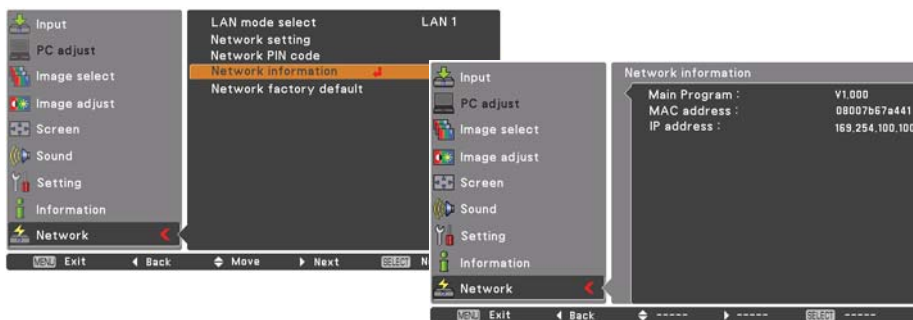

* The numerical value is a setting example.

Network factory default

1. Select "Network factory default" in the Network menu and press **SELECT** button.
2. A confirmation box appears and select "Yes" and then press **SELECT** button.
3. Another confirmation box appears and select "Yes" and then press **SELECT** button.
4. All the wired LAN settings will go back to the factory default settings. For details, refer to "Wired LAN factory default settings" (p.16).

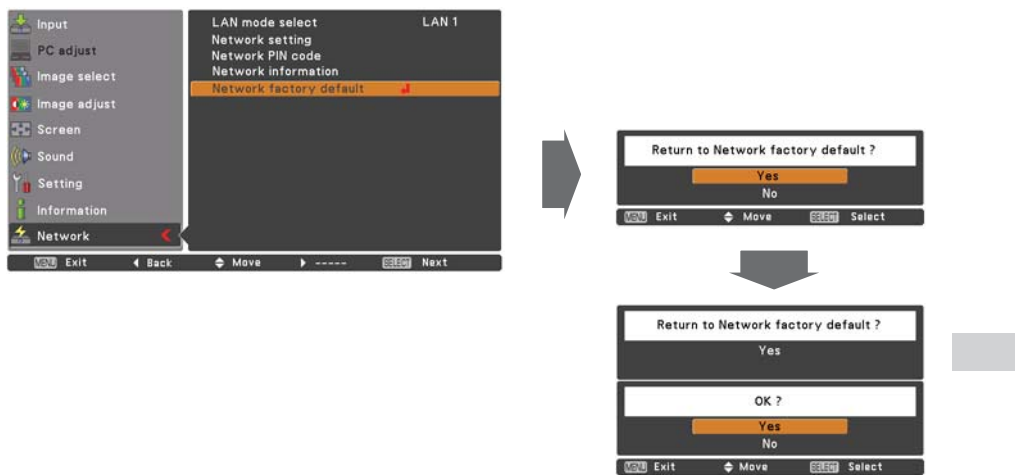

Wired LAN factory default settings

.....

Parameter	SELECTED LAN		
	LAN 1	LAN 2	LAN 3
DHCP	OFF	ON	OFF
IP ADDRESS	169.254.100.100	192.168.100.100	192.168.100.100
SUBNET MASK	255.255.0.0	255.255.255.0	255.255.255.0
GATEWAY ADDRESS	255.255.255.255	255.255.255.255	255.255.255.255
DNS ADDRESS	255.255.255.255	255.255.255.255	255.255.255.255

Chapter 3

Basic Setting and Operation

Describes basic operations and settings for controlling the projector by using the web browser. It is required that computer and projector is connected to the network and the network address is properly configured.

3

Login the setting page of the projector

[1] Enter the IP address

Launch the web browser installed in your computer, enter the IP address into the "Address" on the browser and then press "Enter" key.

Enter the address that you configured in item "Network configuration" (p.12).

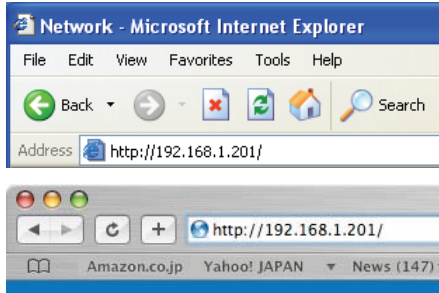

* The numerical value is a setting example.

[2] Login

If the setting page has set the password, the authentication window will appear. In this case type "user" onto the **User name** text area and the login Network PIN code onto the **Password** text area and then click **OK (Log in)** button.

* The entering User Name must be "user" and it can not be changed.

[Note]

When accessing the projector for the first time or the Network PIN code "0000" is set, the auto-login will be performed and the next main setting page is displayed.

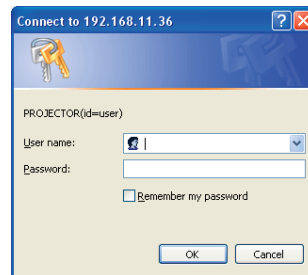

[3] Display of main setting page

The following main setting page will be displayed according to your display mode selection. Perform various kinds of settings through this page. Click on the menus to display the control and setting pages.

Main setting page in the display

The screenshot shows the projector's main setting page. On the left is a vertical 'Main menu' with icons and labels: Initial setting, Power & Status, PC Adj, Control, Setting, E-mail setting, Network, Information, and SNMP setting. The 'Control' menu item is highlighted. The main area displays the 'Control' sub-menu with options: Input/ System/ Sound/ Image adj. Below this are various settings: Contrast (32), Brightness (32), Color (32), Tint (32), Color temp. (Mid), White balance (Red, Green, Blue, each at 32), Sharpness (8), Gamma (8), Noise reduction (L1), Progressive (L1), and buttons for Reset, Store (Image1), and Load (Standard). A 'Sub menu tab' is located on the right side of the screen.

Main menu
For selection of control and setting items of the projector.

Setting page
Displays the control and setting items according to the selected menu.

Sub menu tab
Switches the sub menu tab.

How to use the setting page

To control and set up the projector, use the setting menus on the web browser. Describes the basic operation and procedures commonly used on this manual.

Example of the setting page

The setting menu appears when clicking the sub menu tab.

* Each item has a valid setting range respectively.



Types of setting

Text box setting

Enter a number or text and then click **Set** button.

or

Change a value with – or + button.

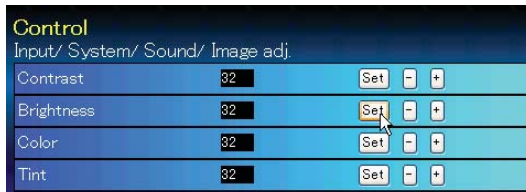

Pull-down menu setting

Select an item with pull-down menu button and then click **Set** button.

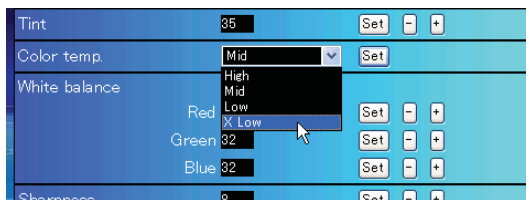

- ☞ The value in the text box indicates current value.
- ☞ Each item has a valid setting range. The setting value exceeding this becomes invalid. Some control items can not be used depending on the selecting input mode or functions of the projector you use. In this case, the values of those items are indicated with "---".

Radio button setting

Select an item by selecting a radio button.

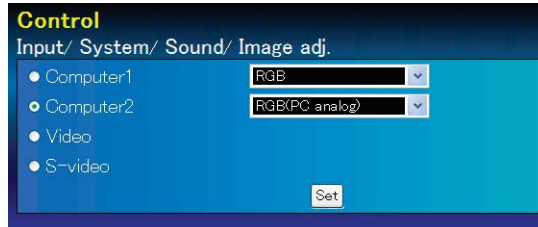

Check box setting

Select items by ticking on check boxes.

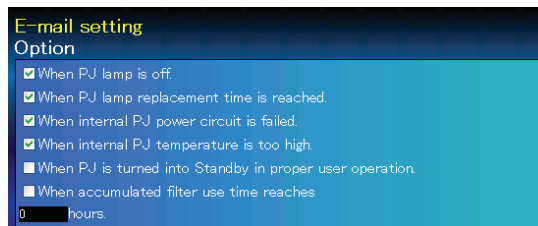



Initial setting

After installing the projector, perform the following basic initial setting. Click **Initial setting** on the main menu to display the initial setting page.



Item	Description
Language.....	Switches display language on the setting page. (Japanese, English)
Model name	Indicates the model name of the projector.
Network PIN code	Sets the Network PIN code to login the setting page. (p.23)
PJLink.....	Switches PJLink password authentication. (ON, OFF) (p.23)
Password.....	Password for PJLink function. (p.23)

Network PIN code setting

This is to set the Network PIN code to restrict the access from an unauthorized person through the network.

Enter a 4-digit number as the Network PIN code onto the text box and click **Set** button.

The projector begins restarting and it takes about 10 seconds. Close (Quit) the web browser and access to the login page again in 10 seconds. This is to perform the login authentication firmly.

The default Network PIN code [0000] means no Network PIN code is set.

The screenshot shows the 'Initial setting' page with the following fields: Language (English), Model name (XU3001), Network PIN code (1234), PjLink (OFF), and Password (empty). A mouse cursor is pointing at the 'Set' button next to the Network PIN code field. The version number 'Ver. 1.000' is displayed at the bottom.

☞ When you connect the projector to the network, it is recommended to set a new Network PIN code. Only a four-digit number is valid for the Network PIN code.

PJLink and password setting

This is to set the PJLink password authentication on or off. If set "ON" with the PJLink pull-down menu, the password must be required. Enter a **password*** onto the text box and click **Set** button.

The screenshot shows the 'Initial setting' page with the following fields: Language (English), Model name (XU3001), Network PIN code (1234), PjLink (OFF), and Password (4321). A mouse cursor is pointing at the 'Set' button next to the Password field. The version number 'Ver. 1.000' is displayed at the bottom.

*1 to 32 alphanumeric characters can be used for the password.

What's PJLink?

The projectors equipped with PJLink function can be used together on the same network, regardless of model or brand, for centralized control and monitoring. This standard was established by the Japan Business Machine and Information System Industries Association (JBMIA). Please visit the Website at <http://pjlink.jbmia.or.jp/english/>.

PJLink Notice

The projector is compliant with PJLink Standard Class 1 of JB MIA, and it supports all commands defined by PJLink Class 1 and is verified conformance with PJLink Standard Class 1.

Projector Input		PJLink Input	Parameter
Computer 1	RGB	RGB 1	11
	Component	VIDEO 2	22
	RGB (Scart)	RGB 2	12
Computer 2	RGB (PC analog)	RGB 3	13
	RGB (PC digital)	DIGITAL 1	31
	RGB (AV HDCP)	DIGITAL 2	32
Video	Video	VIDEO 1	21
	S-video	VIDEO 5	25



Network configuration

Click **Network** on the main menu. The following setting page is displayed. The IP Address, Subnet Mask, Default Gateway, DNS (Domain Name Server) and projector name are set up on this menu.

The IP address and Subnet Mask have been configured already in chapter "Installation". If you want to change them or configure default gateway or DNS, perform them in this page. If you change them, the projector begins restarting and it takes about 10 seconds. Close (Quit) the web browser and access to the login page again in 10 seconds.



Item	Description
------	-------------

LAN mode	Displays the selected LAN mode.
----------	---------------------------------

IP configuration	Sets DHCP or Manual.
------------------	----------------------

IP address	Sets IP address of the projector.
------------	-----------------------------------

Subnet mask	Sets Subnet mask according to your network environment.
-------------	---

Default gateway*1	Sets IP address of the default gateway (Router).
-------------------	--

DNS*2	Sets IP address of the DNS server.
-------	------------------------------------

Projector name*3	Sets name of the projector. (64 characters maximum)
------------------	---

☞ You must use the number specified by your administrator. The address must be entered as a group with four numbers split by a dot like [192.168.001.101].

*1 Set [0.0.0.0] if the network does not provide the gateway (router).

*2 Set [0.0.0.0] if you do not use the function E-Mail alert.

*3 If you use the DNS server, register the host name registered to the DNS server as a projector name. You can access with this projector name from any computers in your network. If you do not use the DNS server, access with the assigned IP address to the projector.

* The selected LAN mode will reset to the default when setting [0.0.0.0] of the IP Address.

* If you make incorrect settings, you cannot find out the new network settings. Be careful to set up them correctly, otherwise you cannot connect to the projector. It is recommended to make a note of them.



E-mail setting

This projector has an E-mail function which can send an alert message to users or an administrator if it detects an abnormality on the projector or run out of the life span of the lamp. So must be set this E-mail setting. Click

E-mail setting on the main menu and follow the below steps.

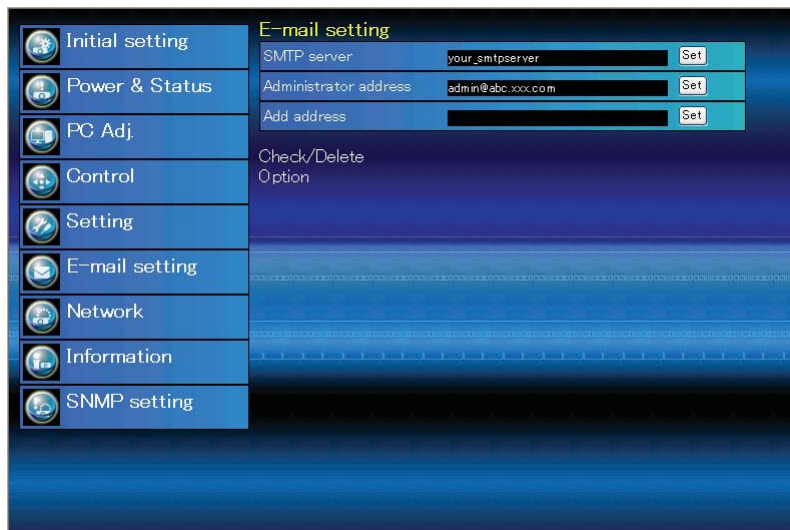

Item	Description
SMTP server*1.....	Sets server name or IP address of the SMTP server
Administrator address.....	Sets e-mail address of administrator
Add address.....	Sets e-mail address of the user to send mail when the projector has an abnormality.

1 Setting SMTP server and administrator address

Set the server name or IP address of the SMTP server*1 and administrator address. The administrator address is set to "Reply-To" address of the message sent from the projector.

*1 The SMTP server is a server for sending E-Mail. Please contact your network administrator to have this SMTP server address.

- ☞ If the projector sends an alert message due to the abnormality on the projector but the SMTP server is down in some other reason, the message will not be sent. In this case, the message "Unable to connect to server." will be displayed on the setting page. To clear this message, set up SMTP server address again.
- ☞ To use the E-Mail function, it must be set the DNS address on the Network setting page correctly.
- ☞ You cannot use this E-mail function if the DNS server and SMTP server cannot be used in your network environment.
- ☞ The projector does not send message to the address set in "Administrator address" text box. If you want to send e-mails to the administrator address, enter the administrator address into "Add address" text box.

2 Registering and deleting E-mail addresses

Click "Add address" and type the e-mail address onto the text box and click **Set** button. To check the registered addresses, click **Check/Delete** sub menu tab. The addresses are listed as the figure on the right.

☞ Up to 10 E-mail addresses can be registered.



Check / Delete

To delete the registered addresses, check the address you want to delete and click **Delete** button.



3 Option selection for sending alert mail

Click **Option** sub menu tab. Check the condition items under which alert mail will be sent and click **Set** button.

Please refer to item "Examples :Type and contents of alert mail" described on the next page.

Option

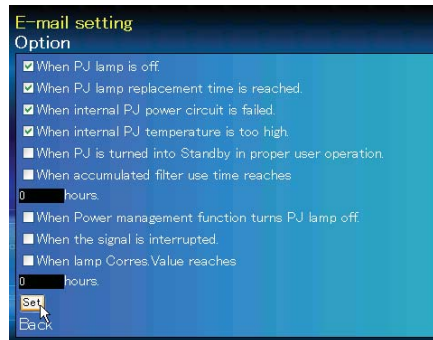

☞ "When PJ lamp is off" signifies the lamp goes out without user operation. "When PJ is turned into Standby in proper user operation" signifies that the projector is turned on by using the web browser and then it is turned into standby with ON/STAND-BY button on the top control or the remote control.

☞ Up to 99,999 hours can be set for use time.

Examples: Type and contents of alert mail

When the projector has an abnormality, the following alert messages are sent to the registered E-mail address according to your selected condition. Administrator or user can take an efficient action quickly by receiving this message. This is very useful to maintain and service the projector.

The following are examples of received messages.

● When internal PJ temperature is too high:

TITLE: Message from projector
 Projector Model Name: *model name*
 TCP/IP: 192.168.1.201 Projector Name: Proj05

It sends you following message.

*The Projector lamp is turned off, because internal projector temperature is too high.
 Wait for the completion of the cooling process and make sure the projector has been turned into Standby. Then turn the projector on again.
 If the Indicator continues flashing, check the air filter for dust accumulation.

● When internal PJ power circuit is failed:

TITLE: Message from projector
 Projector Model Name: *model name*
 TCP/IP: 192.168.1.201 Projector Name: Proj05

It sends you following message.

*The Projector lamp is turned off, because Projector power circuit is failed.
 Unplug the Projector from AC outlet and ask servicing to qualified service personnel.

MCI	3.3V	OK	
MAIN	ALL	NG	← Error information

 The projector lamp was turned off, because the projector power circuit failed. Unplug the AC power cord and plug it, and then turn on the projector once again to verify operation. If the problem still persists, unplug the AC power cord and ask servicing to a qualified service personnel with the error information.

● **When PJ lamp replacement time is reached:**

TITLE: Message from projector
Projector Model Name: *model name*
TCP/IP: 192.168.1.201 Projector Name: Proj05

It sends you following message.

*The projector lamp has reached replacement time.
Lamp ON 2000 h

✎ Replace it with a new lamp immediately and reset the lamp counter. If the projector is used without resetting the lamp counter, the alert mail is sent to users in every power-on of the projector. This alert mail will not be sent when unchecking the mail sending condition "When PJ lamp replacement time is reached".

● **When lamp corres. value reaches preselect use time:**

TITLE: Message from projector
Projector Model Name: *model name*
TCP/IP: 192.168.1.201 Projector Name: Proj05

It sends you following message.

*The accumulated lamp use time has reached 2000 hours.



SNMP setting

This projector provides a SNMP (Simple Network Management Protocol) agent function. The SNMP consists of a manager and agents. The group which communicates information each other with SNMP is called "Community". There are two access modes in a community, Refer (read only) and Set (read-write). This projector allows to use Refer (read only) only. The SNMP message informs the projector status called "Trap" to an administrator. Click **SNMP Setting** on the main menu and set up each item.

PJ information

Item	Description
Contact	Enter user name of the projector etc. (optional).
Place	Enter place of the projector (optional).
Community name(refer)	Enter community name (read only). Default name is "public".

Trap

Item	Description
Community name	Enter community name to send "Trap". Default name is "public".
Trap address	Enter IP address of the SNMP manager computer to receive "Trap".

Trap check/delete

Check and delete the trap address

Checking the registered trap address and deleting the address.

To delete the address, tick check box in front of the IP address and click **Delete** button.



☞ Up to 10 trap addresses can be registered.

Trap option

Trap option setting

Tick check boxes in front of the condition item to send the trap.

☞ Click **Set** button if you tick or un-tick the check box on a page.

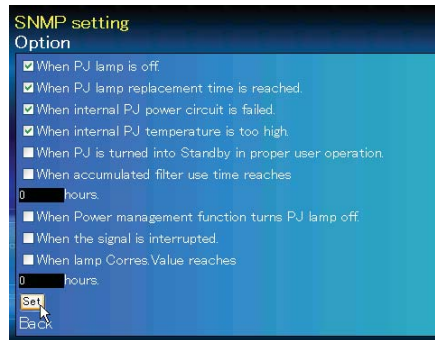

☞ "When PJ lamp is off" signifies the lamp goes out without user operation. "When PJ is turned into Standby in proper user operation" signifies that the projector is turned on by using the web browser and then it is turned into standby with ON/STAND-BY button on the top control or the remote control.

☞ Up to 99,999 hours can be set for the time setting.

Chapter 4

Controlling the Projector



Describes controlling and setting of the projector by using the web browser.



Power control and status check

Click **Power & Status** on the main menu. The control page will be displayed.

By clicking **ON** or **Standby** button on the page, the power of the projector can be controlled.

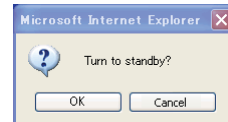

Popup confirmation window

Item	Description
PJ status	
Power	Displays the status of the lamp. (ON, OFF, On starting up, On cooling down)
Status	Displays the status of the projector's power. (Refer to next page.)
Power control	Controls the projector power by clicking the "ON" or "Standby" button.

☞ The projector cannot be turned on while the projector is on cooling down.
 ☞ The web browser checks and updates the projector's condition every 30 seconds automatically.

About projector condition

Status	Description
Normal.....	Projector is operating normally.
Power management in operation.....	Power management is operating.
Lamp failure.....	Lamp failure is occurring.
Abnormal Temperature.....	The temperature of the projector became too high.
Standby after Abnormal Temp.....	Projector detects abnormal temp. and sets into standby mode.
Power failure	Power failure has occurred inside the projector. Projector is turned off. Unplug the AC cord and ask servicing to a qualified service personnel.

When a security (PIN code lock) has been set on the projector, you also cannot control it through the network. To control the projector through the network, unlock the security on the projector using with the projector's menu control.

Caution about turning on/off the projector via the networks

When turning on/off the projector via the networks, preset the projector as follows:

1. Select "Setting" from the Projector menu.
 2. Select "Standby mode" from the Setting menu and set it as "Network".
- If you set this function as "Network", the network part of the projector is constantly provided with power even if the projector is turned off. If you set this as Eco, then the network part will be turned off when you turn off the projector. Consequently, you cannot turn on/off the projector via the networks.



Control

Click **Control** on the main menu. The setting method differs depending on the contents of the page. Click on the page number to change pages and select desired setting items.

Please see the user's manual of the projector to have the further information of each control item.



Input

This function is to select the input mode and source mode of the projector. Click **Set** button after selecting the input and source mode.

Item	Description
Input.....	Selects input mode of the projector.
Source.....	Selects signal source of the input.
	Computer1 : RGB Component RGB(Scart)
	Computer2 : RGB(PC analog) RGB(PC digital) RGB(AV HDCP)
	Video
	S-video

The control page displays valid control items depending on the selected input mode, signal or functions of the projector you use, therefore, there may be different controls between the described items and actual control items on the page display. For further information, refer to the projector's user's manual.

When the projector is in standby, all the controlling items are inactive.

System

This function is to select the system of signal input to the projector. The available system mode are listed on the pull-down menu button according to the input signal. Select a system and then click **Set** button.

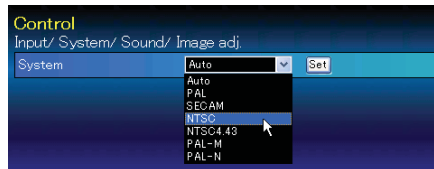

Available selection at the RGB(PC analog) input

Item	Description
XGA1	It automatically switches to the proper computer system of the input signal. * The computer system modes (VGA, SVGA, XGA, SXGA, UXGA, WXGA...) which meet the input signal are listed.

Available selection at the RGB(PC digital) input

Item	Description
D-XGA.....	It automatically switches to the proper computer system of the input signal. * The computer system modes (D-VGA, D-SVGA, D-XGA, D-SXGA1...) which meet the input signal are listed.

Available selection at the RGB(AV HDCP) input

Item	Description
D-480p	It automatically switches to the proper scanning system of the input signal. * The selectable scanning systems are D-480p, D-575p, D-720p, D-1035i and D-1080i.

Available selection at the Video/S-video/Scart input

Item	Description
AUTO.....	It automatically switches to the proper color system of the input signal. * The selectable color systems are PAL, SECAM, NTSC, NTSC4.43, PAL-M and PAL-N. * AUTO is fixed at the Scart input.

Available selection at the Component input

Item	Description
AUTO.....	It automatically switches to the proper scanning system of the input signal. * The selectable scanning systems are 480i, 575i, 480p, 575p, 720p, 1035i and 1080i.

☞ If the mode (Mode1 to Mode5) which is stored in the item "PC Adjustment" (p.38) is available, they are also listed together with the above mode.

Sound

This function is to adjust the sound of the projector. The values in the text box represent the current control value or status.

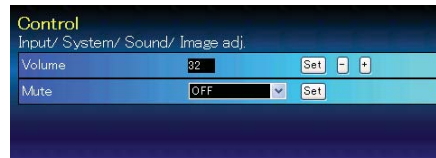

Item	Description
Volume	Adjusts the sound volume from the speaker. (0 ~ 63)
Mute.....	Suppresses the sound. (ON, OFF)

Image adjustment

This function is to adjust the projected picture image and save the image mode. To store the adjusted value, click **Store** button, and to load the adjusted value, click **Load** button.

Item	Description
Contrast.....	Adjusts picture contrast (0~ 63)
Brightness.....	Adjusts picture brightness (0~ 63)
Color.....	Adjusts picture color saturation (0~ 63)
Tint.....	Adjusts picture hue (0~ 63)
Color temp.....	Sets a color temperature mode. (X Low, Low, Mid, High, User)
White Balance	
Red, Green, Blue.....	Adjusts each white balance respectively. (0~ 63)
	* When changing the value of the white balance, the color temp. indicates "User"
Sharpness.....	Adjusts picture sharpness. (0~ 15)
Gamma.....	Adjusts brightness of darker part of the picture. (0~ 15)
Noise reduction.....	Switches noise reduction mode (OFF, L1, L2)
Progressive.....	Switches progressive mode (OFF, L1, L2, Film)
Reset.....	Resets the Image adjustment to previous levels.
Store.....	Stores the Image adjustment values. Select an item [Image1 - Image4] from the pull-down menu and click Store button.
Load.....	Loads the Image mode. Select an image mode from the pull-down menu and click Load button. There may not be available mode depending on the input mode as shown in the table left.



Image mode	Input source	
	Video	Computer
Dynamic	✓	✓
Standard	✓	✓
Cinema	✓	*
Real	*	✓
Blackboard(Green)	✓	✓
Colorboard	✓	✓
Image1 - 4	✓	✓

The mark "✓" means that the available image mode in the selected input source. The error message appears when selecting the disabled image mode indicated with "*".



PC adjustment

Click **PC Adj.** on the main menu. This function is to adjust the signal from the computer connected to the projector to obtain the proper picture image on the screen.

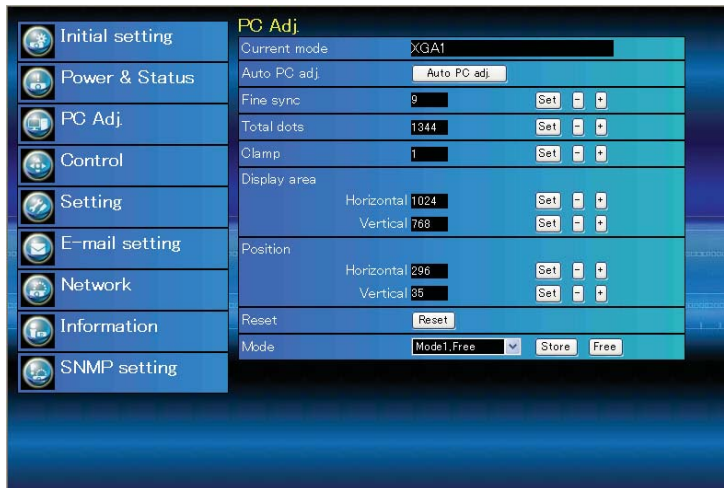

Item	Description
Current mode	Displays a current mode like VGA, SVGA, XGA, SXGA, UXGA, WXGA, etc. or Mode1 - Mode5 which are the customized mode created by using the "Mode Store" function described below.
Auto PC adj.	Performs automatic adjustment.
Fine sync.	Performs Fine Sync adjustment. (0 ~ 31)
Total dots	Adjust the number of total dots in the horizontal period.
Clamp	Adjusts the phase of the clamp.
Display area	
Horizontal	Adjusts the image area horizontally.
Vertical	Adjusts the image area vertically.
Position	
Horizontal	Adjusts the horizontal position of the screen.
Vertical	Adjusts the vertical position of the screen.
Reset	Resets the PC adjustments to the previous levels.
Mode Store	Stores the PC adjustment values. Select a mode no. [Mode1 - Mode5] from the pull-down menu.
Mode Free	Clear the PC adjustment values. Select a mode no. [Mode1 - Mode5] from the pull-down menu.



Setting up the projector

Click **Setting** on the main menu. This function is to set up the projector. Select the sub menu [Screen setting] or [Setting] and then set up each setting.



Screen setting

This function is to adjust the screen mode of the projector. The values in the text box represent the current screen status.

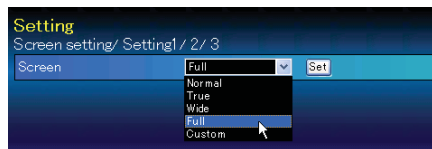

Item	Description
Screen	Switches the screen mode. (Normal, True, Wide, Full, Custom) There may not be available mode depending on the input mode as shown in the table below.

Input source		
Screen mode	Video	Computer
Normal	✓	✓
True	*	✓
Wide	✓	✓
Full	*	✓
Custom	✓	✓

The mark "✓" means that the available screen mode in the selected input source system. The error message appears when selecting the disabled screen mode indicated with "*".

Setting 1

Item	Description
Language.....	Sets the language display of projector's on-screen display menu.
Auto setup.....	Executes the Auto PC adj., Input Search and Auto keystone function below according to the each setting after clicking Start button.
Auto PC adj.....	Sets Auto PC Adjustment mode. (ON, OFF)
Input search.....	Sets the auto-input signal detection mode. (ON1, ON2, OFF)
Auto keystone.....	Sets Auto Keystone mode. (Auto, Manual, OFF)
Background.....	Sets the screen background when no signal input. (Blue, User, Black)
Display.....	Switches on or off the on-screen menu display on the screen. (OFF, Countdown Off, ON)
Countdown off.....	Displays image during the starting up.
Logo.....	Sets on or off the logo display on the screen during the startup. (OFF, Default, User)

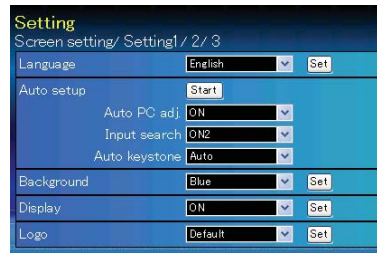

Setting 2

Item	Description
Ceiling.....	Sets the image top/bottom and left/right reversed. (ON, OFF)
Rear.....	Sets the image left/right reversed. (ON, OFF)
Power management.....	Sets into the selected power management mode (Ready, Shutdown, OFF) if the input signal is interrupted and no control key is pressed for the specified period of time. *The specified time can be set 1 to 30 min.
Direct on.....	Sets the power-on mode when the AC cord is connected to the outlet. (ON, OFF)
Lamp control.....	Selects lamp control mode. (Normal, Eco)
Lamp life control.....	Selects lamp life control mode (Mode1, Mode2) when the total use time exceeds the recommended total hours of use.

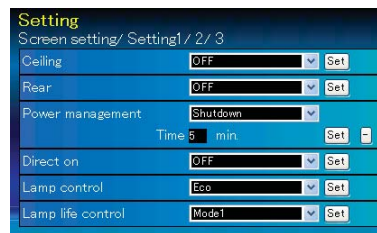

Setting 3

Item	Description
Key lock.....	Sets the prohibition of controls either Projector or Remote control. (OFF, Projector keys, Remote control)
Fan control.....	Sets the fan control speed. OFF Normal mode ON1 Highland mode 1 ON2 Highland mode 2
Filter counter.....	Displays the filter counter. Reset the time after filter clean-up. Click "Reset", a confirmation display appears, and then click "OK", the time will be reset.
Filter warning.....	Sets the time to indicate the filter warning message on the screen. (OFF, 100H, 200H, 300H)
Factory default.....	Sets all of the projector control items to the factory default setting except the following items. User Logo, Logo PIN code lock, PIN code lock, Lamp Corres. Value, PJ Time, Filter counter * This function is effective for all the Network settings.
No show.....	Sets the black out image temporarily. (ON, OFF)
Freeze.....	Sets the image to freeze mode. (ON, OFF)
Closed caption.....	Sets the closed caption function. Closed caption...Sets the closed caption mode. (OFF, CC1, CC2, CC3, CC4) ColorSets the color of the contents. (Color, White)

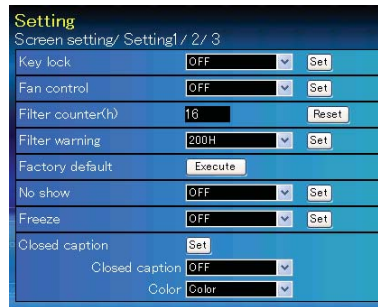



Information

This page is to display the basic information of the projector status. Click **Information** on the main menu.

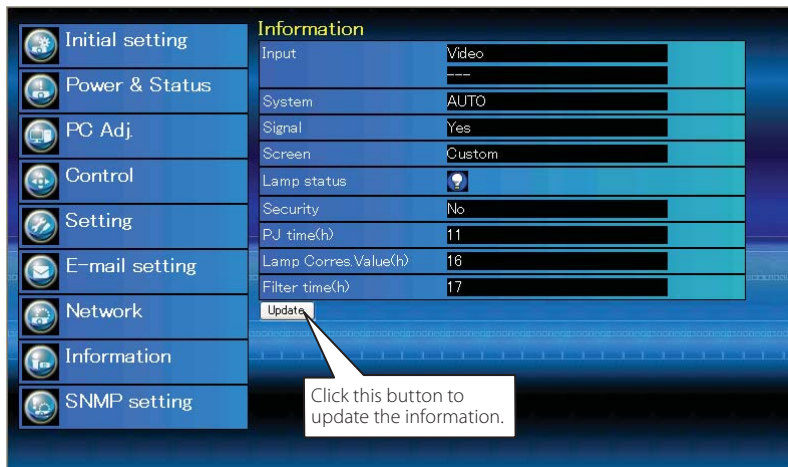

Items	Description
Input	Displays selected input and source.
System	Displays selected signal system.
Signal	Input signal status (Yes, No)
Screen	Displays screen mode.
Lamp status	Displays lamp status with an icon. Refer to the table as shown below.
Security	Displays the security (PIN code lock) status (Yes, No)
PJ time(h)	Displays the accumulated use time of the projector.
Lamp Corres. Value(h)	Displays the use time (Corresponding value) of the lamp.
Filter time(h)	Displays the accumulated use time of the filter.

Indication of the lamp status

Icon display/background	Status
White/Blue	Lamp on (Normal)
White/Red	Lamp on (Lamp is being used over a specified use time, replace lamp immediately)
Gray/Blue	Lamp off (Normal)
Gray/Red	Lamp off (Lamp is being used over a specified use time, replace lamp immediately)
Red/Blue with X	Lamp failure (Lamp failure, check lamp condition)
Red/Red with X	Lamp failure (Lamp failure and lamp is being used over a specified use time, replace lamp immediately)

Chapter 5

Appendix



Connection examples
 Use of telnet
Web browser setting
 Q & A

Examples of connection

Peer-To-Peer connection

Connecting the projector (PJ01) to the control computer (PC05) directly.

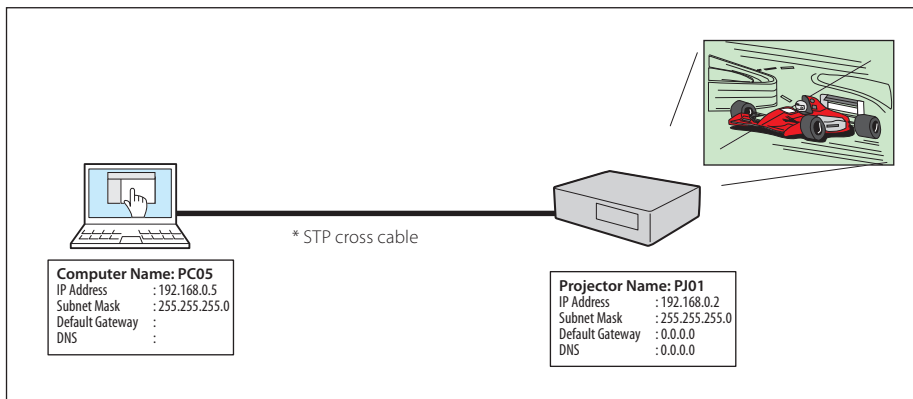

Connecting the projector (PJ01) to the control computer (PC05) via the hub.

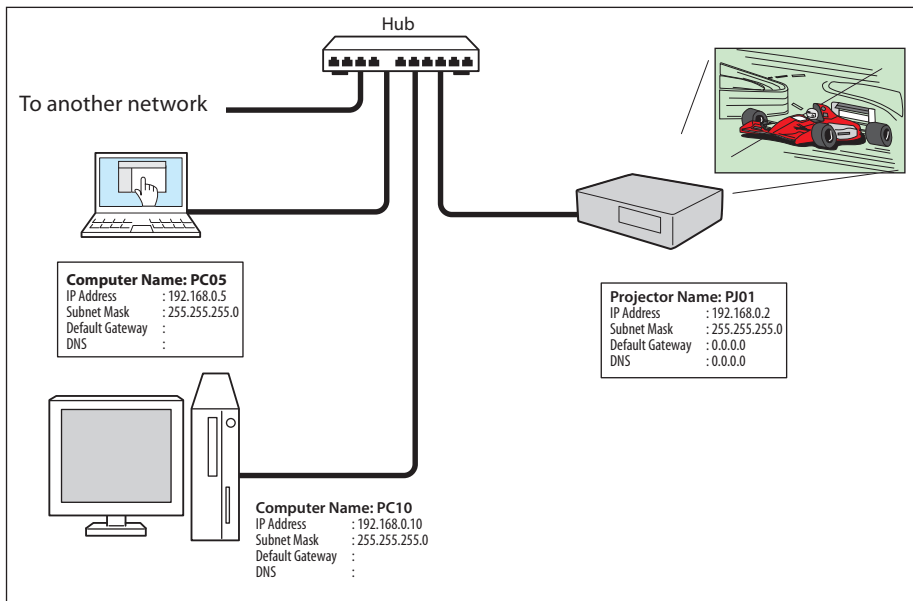

When the projector is connected to the computer directly without hub, the STP cross cable should be used.

The gateway (Router) installed in the network

Connecting the projector (PJ01) to the control computer (PC05) via the gateway.

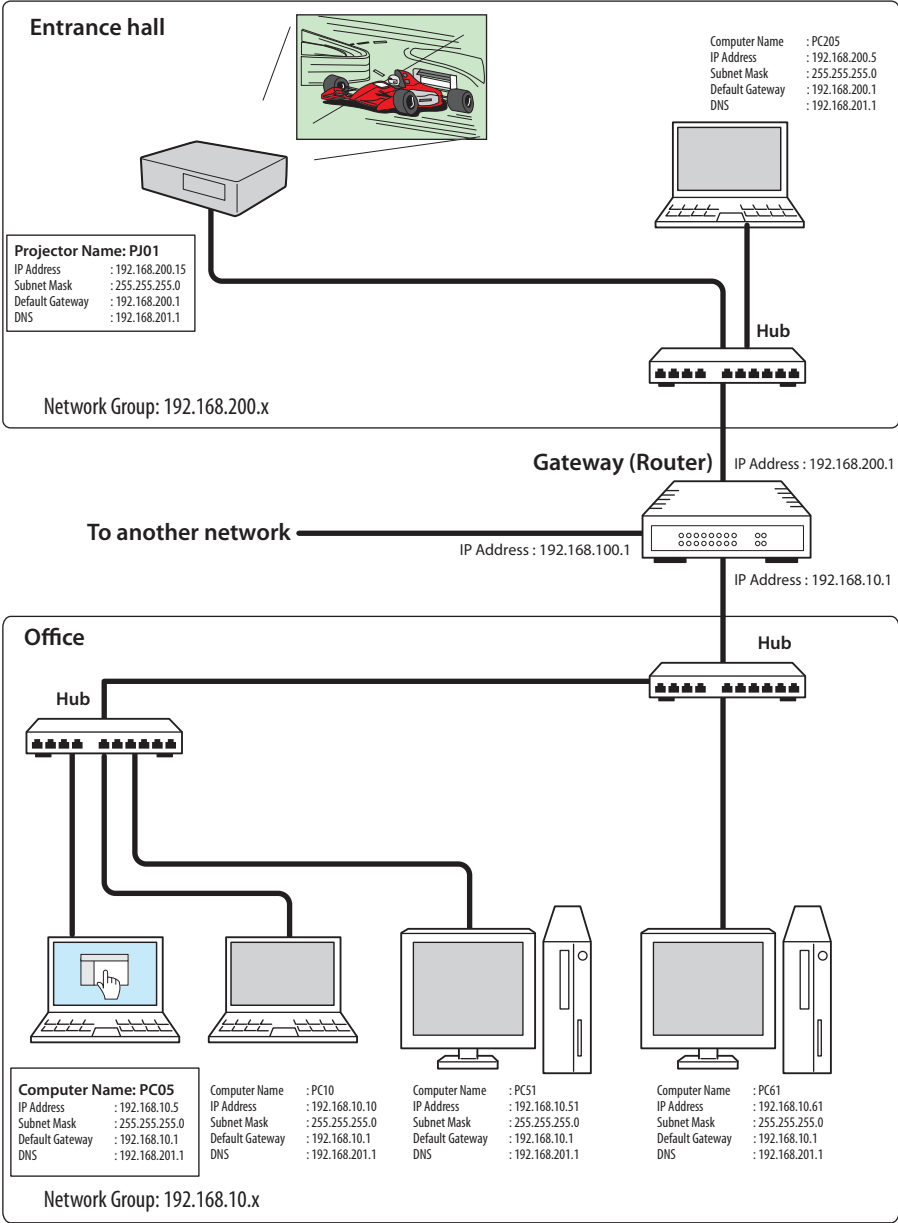

Use of telnet

You can control the projector by using the telnet application¹ installed on your computer. Normally, the telnet application is available on your computer.

* The telnet 10000 port is used to control the projector.

Control

(For example, in case of using the telnet application of **Windows XP Professional**.)

1. Select **Run...** submenu from **Start** menu on the computer. Type "telnet" onto the **Open** text area on the displayed window and press **OK** button.

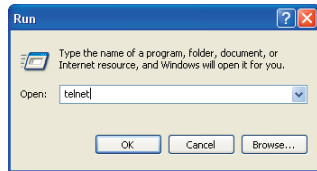

(For example, in case of using the telnet application of **Mac OS X v 10.4**)

1. Select **Terminal** from **Applications** --> **Utilities**.

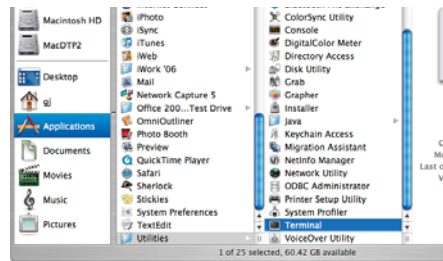

Type as below on the displayed window.
> telnet [return]

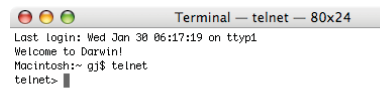

2. The telnet application will start and the following window will be displayed. Type as below to connect the projector.

> open 192.168.1.201 10000 [return]

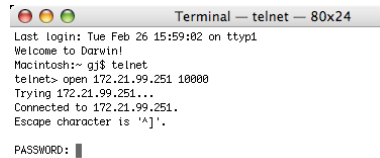
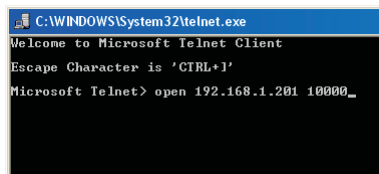

* Use the IP address assigned to the projector.

3. When communication is established correctly, the word "PASSWORD:" appears on the window. Type the login password (Network PIN code*) for the projector and then press "Enter" key on the keyboard. If you do not set up the Network PIN code, just press "Enter" key.

When the word "Hello" is replied, login has been succeeded.

* The password "1234" is used for the example.

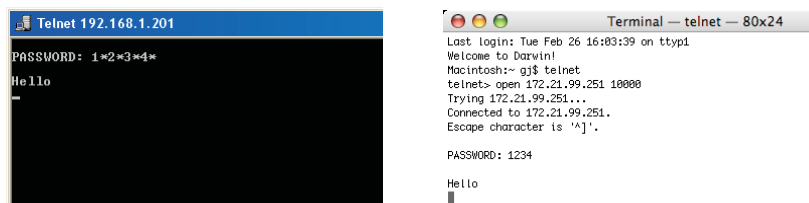

4. Type the commands, refer to below table, to control the projector and then press "Enter" key for termination. For example, type "C00" which is a command to turn on the projector, and press "Enter" key. Confirm the projector is turning on.

* Enter with ASCII 64-byte capital characters and one-byte characters.

To disconnect the communication, press "Ctrl" key and "]" key at the same time, type "close" and then press "Enter" key on the Keyboard.

> close [return]

The table below shows the typical command lists for controlling this projector and please consult your local dealer for further information of another commands.

Command list table

Command	Function
C00	Power on
C02	Power off
C09	Volume up
C0A	Volume down
C0B	Audio Mute on
C0C	Audio Mute off
C1C	Menu display on
C1D	Menu display off

*1 Further instructions about the telnet application, please see the on-line guide on your computer.

*2 The password is a Network PIN code decided item "Network PIN code setting" (☞pp.14, 23). If the authentication of the entered password is failed 4 times continuously, the communication will be disconnected automatically. Please try again for the connection.

☞ If the password or any command is not entered for more than 30 seconds, the communication will be disconnected automatically. Please try again for the connection.

Web browser setting

This projector is designed to be set up and controlled from an Internet web browser. Depending on the preference settings of the web browser, some control functions may not be available. Please make sure that the following functions are set up properly in the web browser.

Active Script/JavaScript enable

There are some control items used with the JavaScript function in the setting pages. If the web browser is set not to use this JavaScript function, it may not control the projector properly. In this case, the warning message "Make sure JavaScript is ON." will be displayed on the top of the page. To enable the JavaScript, please see further instructions on the next page.

Proxy setting

In some cases, your web browser is set up to use the proxy server for the internet or intranet connection. In this case, when you install this projector into the local network, you should set up the proxy setting of web browser preference correctly. Especially when connecting the projector and computer with a STP cross cable directly, or when the network does not provide the proxy server, make sure that "not use proxy server" is set up in your web browser preference. Please see item "Examples: OS/Browsers" in the next page for further setting up procedure.

 There are various ways to change your browser preferences depending on the version or applications. Please see the setting instructions on next page for example and also refer to on-line help of your web browser.

Examples: OS/Browsers

Windows XP Professional

Internet Explorer v.6.0

ActiveScript setting

Select **Internet Options** from **Tools** menu on the web browser and then select **Security** tab and click **Customize Level...** button. On the security setting window, scroll down and find the **Scripting** item, make sure that "Enable" is selected in item **Active Scripting**.

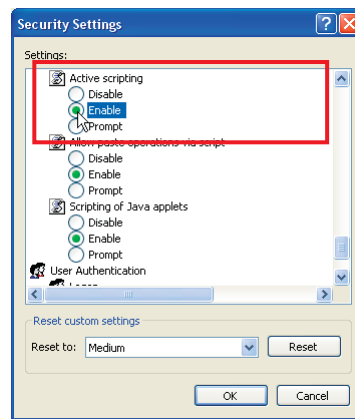
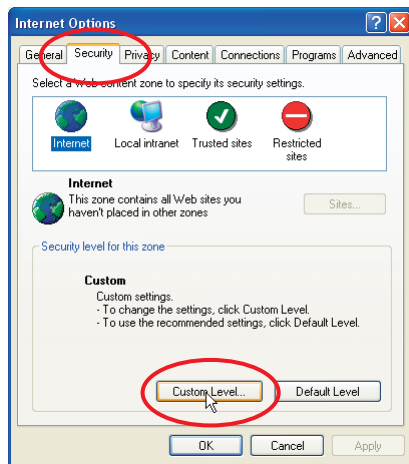

Proxy setting

Select **Internet Options** from **Tools** menu on the web browser and then select **Connection** tab and click **LAN Settings** button. Properly set up your web browser's the proxy server settings according to the local area network environment to which the projector is connected.

- Using proxy server

To use an external internet connection from the local area network, check the item **Use a proxy server** and enter the proxy server address and port correctly in the proxy settings window. For further instruction please consult your network administrator.

- Not using proxy server

Uncheck the item **Use a proxy server**.

If you connect the projector to the computer directly with STP cross cable, this must be unchecked.

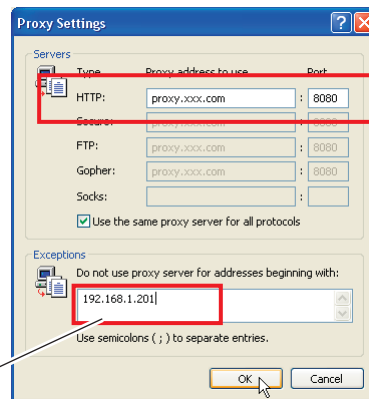
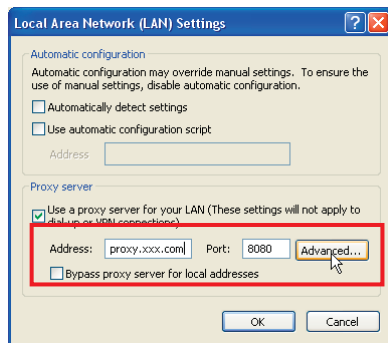

To designate proxy settings that will not use the proxy server when accessing the projector installed in the local area network, enter the IP address or domain name here.

Netscape Navigator v.7.1

JavaScript Setting

Select **Preference** from **Edit** menu on the web browser and then select the item **Advanced/Scripts & Plugins** in the **Category** column. Make sure that the **Enable JavaScript for Navigator** is checked.

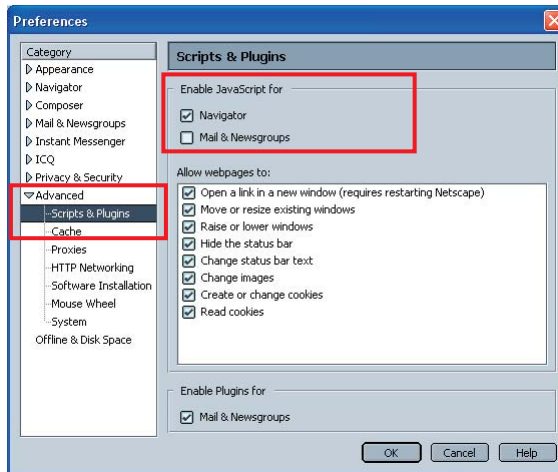

Proxy setting

Select **Preference** from **Edit** menu on the web browser and then select the item **Advanced/Proxies** in the **Category** column. Properly set up your web browser's the proxy server settings according to the local area network environment to which the projector is connected.

- Using proxy server

When you use an external internet connection from the local area network, select the item **Manual proxy configuration**. Enter the proxy server address and port number correctly on **HTTP Proxy** item. For further instruction please consult your network administrator.

- Not using proxy server

Select the item **Direct connection to the Internet** in the proxy setting window. If you connect the projector to the computer directly with STP cross cable, this must be selected.

To designate proxy settings that will not use the proxy server when accessing the projector installed in the local area network, enter the IP address or domain name here.

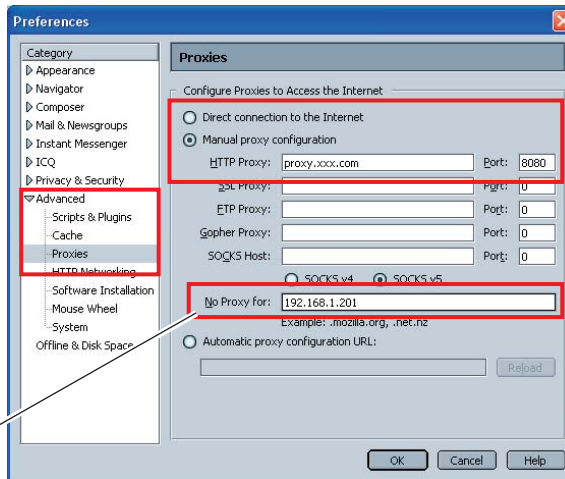

ENGLISH

MAC OS X v 10.4

Safari v.3.2.1

JavaScript enable setting

Select **Preferences...** from **Safari** on the web browser and then select **Security** tab and check **Enable JavaScript**.

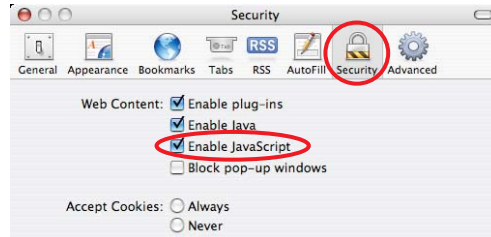

Proxy setting

- 1 Open **Preferences...** from **Safari** menu on the web browser **Safari**. The preference menu appears.
- 2 Select **Advanced** icon and then click **Proxies: Change Settings ...**.
- 3 Select **Proxies** tab and properly set up your web browser **Safari**'s the proxy server settings according to the local area network environment to which the projector is connected.

- Using proxy server

To use an external internet connection from the local area network, check the items **Web Proxy (HTTP)** and **Secure Web Proxy (HTTPS)** of **Select a proxy server to configure** window and enter the proxy server address and port correctly in **Web Proxy Server** window. For further instruction please consult your network administrator.

- Not using proxy server

Uncheck the items **Web Proxy (HTTP)** and **Secure Web Proxy (HTTPS)** of **Select a proxy server to configure**.

If you connect the projector to the computer directly with STP cross cable, they must be unchecked.

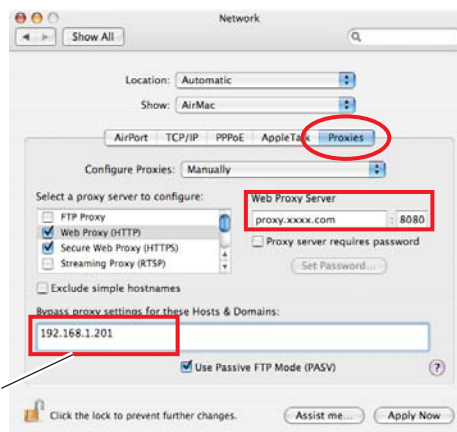
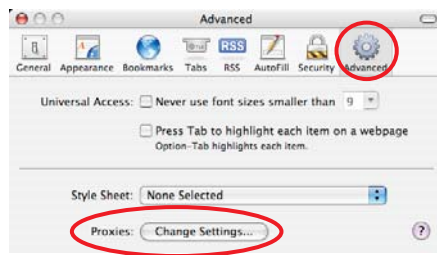

To designate proxy settings that will not use the proxy server when accessing the projector installed in the local area network, enter the IP address or domain name here.

Q&A

Installation/Access

Q *Why doesn't the setting page appear in my web browser?*

- A** Following causes are possible. Please check them.
1. The projector does not connect to the network.
Check LED indicators status (☞ p.12).
 - Check the connection of LAN cable if the LINK Lamp does not light green.
 - Check the network configuration of the projector if the ACT Lamp does not blink orange.
 2. Wrong network configuration of the computer.
Check the network configuration of the computer.
 3. The proxy setting of the web browser is not set correctly (☞ p.50).
 4. The computer does not provide TCP/IP protocol.

Q *How can I restrict access from the computer.*

- A**
1. Please use the password authentication function on the login page (☞ p.23).
 2. Please use the IP filtering function provided with the gateway (router) to restrict the accessing from the computer. For further information please consult your network administrator.

Q *Can I access the projector installed on the company's local area network from a remote location?*

- A** There are some ways to access to the projector in the LAN, but you must consult your network administrator for security reason.
- ☛ Use of modem
(Connect to the company's network from your home or some other places by using modem.)
 - ☛ Use of private line
(Connect to the company's network from the branch office or maintenance office by using private line.)
 - ☛ Use of internet
(Connect to the company's network from your home, branch office or some other places by using the internet.)

Q *We use the DHCP/BOOTP server to assign the IP address. Is it possible to use the projector in this network environment?*

A Possible. This projector supports the DHCP/BOOTP server. To use this projector in this network environment, set it up so that the DHCP/BOOTP server does not assign the IP address configured to this projector for another device on the network. Please consult your network administrator (☞ pp.13, 24).

Q *How can I install several projectors?*

A Install and configure network one by one to avoid the IP address collision each other. To configure the IP address please see item "Network configuration" (☞ pp.12-13, 24).

Password/Login

Q *What should I do when I forget the IP address of the projector?*

A You can check the IP address in the "Network information" menu.

Q *What should I do when I forget the password (Network PIN code)?*

A Please set the new network PIN code in the "Network PIN code" menu.

Q *Can I register the setting page as a web browser "Favorites" or "Bookmarks"?*

A Please add "Login" page to your "Favorites" or "Bookmarks". Do not add the specified setting page because it will not be able to perform the password authentication correctly.

Operation

Q *Why can't be turned on/off with web browser?*

A Please make sure the settings of the projector are correct to use the projector. Please set the **Standby mode** of the projector's **Setting menu** to "**Network**". Refer to "4. Controlling the Projector" → "Power control and status check" (☞ pp.32 - 33).

Q *Why can't I change the controls in the setting page with web browser?*

A Please make sure the projector is turned on. If it is in the standby mode, the setting is not effective to the projector. To control the projector with a web browser, the projector must be in the powered-on condition.

Q *Why does it sometimes take a lot of time to complete the page display?*

A The display speed of the page depends on the network environment in which both the projector and computer are placed. It may take much time to complete the page display if network traffic is heavy. Please consult your network administrator.

Q *How many numbers of the E-mail address can I register in the E-mail setting page.*

A You can register up to 10 addresses.

Q *Why am I not receiving E-mail alert messages?*

A Make sure that the registered E-mail address and SMTP server address are correct. If the SMTP server is located in your LAN (Local Area Network), the address should be set to the SMTP server in your LAN. The SMTP server located outside of your LAN may not be available for security reason. For further information please contact your network administrator (☞ p.25).

Others

Q *What are the rules for IP address assignment?*

A If the network is constructed with TCP/IP protocol, a unique IP address is required for each piece of network equipment. The following are basic rules of the assignment.

Rule1

Do not configure the same IP address to the network equipment in the same network group. Each piece of equipment must be assigned a unique IP address.

If the IP address is set [192.168.x.x], the Subnet Mask should be set [255.255.255.0] for example.

Rule2

The start address [xxx.xxx.xxx.0] and the last address [xxx.xxx.xxx.255] of the IP address must not be assigned to any other equipment. These address numbers are reserved.

Rule3

The IP address must correlate to a network number. If network numbers are different between the equipment, they cannot establish communications each other. In this case, the router is placed in the networks to make the routing.

Q *Can I control the projector by using the telnet application?*

A Possible. Please refer to the item "Use of telnet" (☞ p.46 - 47).

Q *What is the MAC address assigned to the projector?*

A The MAC address is displayed in "Network information" menu of the projector (☞ p.14).

Q *Can I update the firmware of the projector.*

A It is possible to update the firmware through the network. It is required to have a special tool for the updating. For further information please consult your local dealer. The version number of the firmware is indicated on the lower part of the "Initial setting" page.



NETWORK OWNER'S MANUAL
SO-KD5AF



SANYO Electric Co., Ltd.