



# Read this first!

**WARNING:** THIS APPARATUS MUST BE EARTHED.

**WARNING:** To prevent damage which may result in fire or shock hazard, do not expose this appliance to rain or moisture.

Machine Noise Information Ordinance 3. GSGV, January 18, 1991: The sound pressure level at the operator position is equal or less than 70 dB (A) according to ISO 7779.

**WARNING:**

1. Remove the plug from the mains socket when this unit is not in use for a prolonged period of time.
2. To prevent electric shock, do not remove cover. No user serviceable parts inside. Refer servicing to qualified service personnel.
3. Do not remove the earthing pin on the mains plug. This apparatus is equipped with a three prong earthing type mains plug. This plug will only fit an earthing-type mains socket. This is a safety feature. If you are unable to insert the plug into the mains socket, contact an electrician. Do not defeat the purpose of the earthing plug.

**CAUTION:** To assure continued compliance, follow the attached installation instructions, which includes using the provided power cord and shielded interface cables when connecting to computer or peripheral device. If you use serial port to connect PC for external control of projector, you must use optional RS-232C serial interface cable with ferrite core. Any unauthorized changes or modifications to this equipment will void the user's authority to operate.

## Product information (for Turkey only)

EEE Yönetmeliğine Uygundur.  
EEE Complies with Directive of Turkey.



**WARNING:**

TURN OFF THE UV LAMP BEFORE OPENING THE LAMP COVER.

**WARNING:** TO REDUCE THE RISK OF FIRE OR ELECTRIC SHOCK, DO NOT EXPOSE THIS PRODUCT TO RAIN OR MOISTURE.

**WARNING:** RISK OF ELECTRIC SHOCK, DO NOT OPEN.



The lightning flash with arrowhead symbol, within an equilateral triangle, is intended to alert the user to the presence of uninsulated "dangerous voltage" within the product's enclosure that may be of sufficient magnitude to constitute a risk of electric shock to persons.



The exclamation point within an equilateral triangle is intended to alert the user to the presence of important operating and maintenance (servicing) instructions in the literature accompanying the product.

**WARNING:****■ POWER**

**The wall outlet or the circuit breaker shall be installed near the equipment and shall be easily accessible when problems occur. If the following problems occur, cut off the power supply immediately.**

Continued use of the projector in these conditions will result in fire or electric shock.

- If foreign objects or water get inside the projector, cut off the power supply.
  - If the projector is dropped or the cabinet is broken, cut off the power supply.
  - If you notice smoke, strange smells or noise coming from the projector, cut off the power supply.
- Please contact an Authorized Service Center for repairs, and do not attempt to repair the projector yourself.

**During a thunderstorm, do not touch the projector or the cable.**

Electric shocks can result.

**Do not do anything that might damage the power cord or the power plug.**

If the power cord is used while damaged, electric shocks, short-circuits or fire will result.

- Do not damage the power cord, make any modifications to it, place it near any hot objects, bend it excessively, twist it, pull it, place heavy objects on top of it or wrap it into a bundle.

Ask an Authorized Service Center to carry out any repairs to the power cord that might be necessary.

**Insert the power plug securely into the wall outlet.**

If the plug is not inserted correctly, electric shocks or overheating will result.

- Do not use anything other than the provided power cord.
- Do not use the provided power cord for other electrical equipment.
- Do not use plugs which are damaged or wall outlets which are coming loose from the wall.

**Clean the power plug regularly to prevent it from becoming covered in dust.**

Failure to observe this will cause a fire.

- If dust builds up on the power plug, the resulting humidity can damage the insulation.
  - If not using the projector for an extended period of time, pull the power plug out from the wall outlet.
- Pull the power plug out from the wall outlet and wipe it with a dry cloth regularly.

**Do not handle the power plug with wet hands.**

Failure to observe this will result in electric shocks.

**Do not overload the wall outlet.**

If the power supply is overloaded (ex., by using too many adapters), overheating may occur and fire will result.

**■ ON USE/INSTALLATION**

**Do not place liquid containers on top of the projector.**

If water spills onto the projector or gets inside it, fire or electric shocks will result.

If any water gets inside the projector, contact an Authorized Service Center.

**Do not place the projector on soft materials such as carpets or sponge mats.**

Doing so will cause the projector to overheat, which can cause burns, fire or damage to the projector.

**Do not set up the projector in humid or dusty places or in places where the projector may come into contact with oily smoke or steam, ex. a bathroom.**

Using the projector under such conditions will result in fire, electric shocks or components deterioration.

Components deterioration (such as ceiling mount brackets) may cause the projector which is mounted on the ceiling to fall down.

**Do not install this projector in a place which is not strong enough to take the full weight of the projector or on top of a surface which is sloped or unstable.**

Failure to observe this will cause projector to fall down or tip over the projector, and severe injury or damage could result.

**Do not place another projector or other heavy objects on top of the projector.**

Failure to observe this will cause the projector to become unbalanced and fall, which could result in damage or injury. The projector will be damaged or deformed.

## Read this first!

### WARNING:

**Installation work (such as ceiling mount bracket) should only be carried out by a qualified technician.**

If installation is not carried out and secured correctly it can cause injury or accidents, such as electric shocks.

- Do not use anything other than an authorized ceiling mount bracket.
- Be sure to use the wire provided with the projector mount base for ceiling mount as an extra safety measure to prevent the projector from falling down. (Install in a different location to the ceiling mount bracket).

**Do not cover the air inlet port or the air outlet port.**

Doing so will cause the projector to overheat, which can cause fire or damage to the projector.

- Do not place the projector in narrow, badly ventilated places.
- Do not place the projector on cloth or papers, as these materials could be drawn into the air inlet port.

**Do not place your hands or other objects close to the air outlet port.**

Doing so will cause burns or damage your hands or other objects.

- Heated air comes out of the air outlet port. Do not place your hands or face, or objects which cannot withstand heat close to this port.

**Do not look and place your skin into the lights emitted from the lens while the projector is being used.**

Doing so can cause burns or loss of sight.

- Strong light is emitted from the projector's lens. Do not look or place your hands directly into this light.
- Be especially careful not to let young children look into the lens. In addition, turn off the power and disconnect the power plug when you are away from the projector.

**Do not insert any foreign objects into the projector.**

Doing so will cause fire or electric shocks.

- Do not insert any metal objects or flammable objects into the projector or drop them onto the projector.

**Never attempt to remodel or disassemble the projector.**

High voltages can cause fire or electric shocks.

- For any inspection, adjustment and repair work, please contact an Authorized Service Center.

**Do not project an image with the lens cover attached.**

Doing so can cause fire.

**Do not allow metal objects, flammable objects, or liquids to enter inside of the projector. Do not allow the projector to get wet.**

Doing so may cause short circuits or overheating, and result in fire, electric shock, or malfunction of the projector.

- Do not place containers of liquid or metal objects near the projector.
- If liquid enters inside of the projector, consult your dealer.
- Particular attention must be paid to children.

**Use the ceiling mount bracket specified by Panasonic.**

Defects in the ceiling mount bracket will result in falling accidents.

- Attach the supplied safety cable to the ceiling mount bracket to prevent the projector from falling down.



**WARNING:**

■ **ACCESSORIES**

**Do not use or handle the batteries improperly, and refer to the following.**

Failure to observe this will cause burns, batteries to leak, overheat, explode or catch fire.

- Use AAA/R03 or AAA/LR03 batteries.
- Do not use unspecified batteries.
- Do not disassemble dry cell batteries.
- Do not heat the batteries or place them into water or fire.
- Do not allow the + and – terminals of the batteries to come into contact with metallic objects such as necklaces or hairpins.
- Do not store batteries together with metallic objects.
- Store the batteries in a plastic bag and keep them away from metallic objects.
- Make sure the polarities (+ and –) are correct when inserting the batteries.
- Do not use a new battery together with an old battery or mix different types of batteries.
- Do not use batteries with the outer cover peeling away or removed.
- Remove the empty batteries from the remote control at once.
- Insulate the battery using tape or something similar before disposal.

**Do not allow children to reach the batteries (AAA/R03 or AAA/LR03 type).**

- The battery can cause personal injury if swallowed.
- If swallowed, seek medical advice immediately.

**If the battery fluid leaks, do not touch it with bare hands, and take the following measures if necessary.**

- Battery fluid on your skin or clothing could result in skin inflammation or injury.  
Rinse with clean water and seek medical advice immediately.
- Battery fluid coming in contact with your eyes could result in loss of sight.  
In this case, do not rub your eyes. Rinse with clean water and seek medical advice immediately.

**Do not disassemble the lamp unit.**

If the lamp breaks, it could cause injury.

**Lamp replacement**

The lamp has high internal pressure. If improperly handled, an explosion and severe injury or accidents will result.

- The lamp can easily explode if struck against hard objects or dropped.
- Before replacing the lamp, be sure to disconnect the power plug from the wall outlet.  
Electric shocks or explosions can result if this is not done.
- When replacing the lamp, turn the power off and allow the lamp it to cool for at least 45 minutes before handling it otherwise it can cause burns.

**Do not allow infants or pets to touch the remote control unit.**

- Keep the remote control unit out of the reach of infants and pets after using it.

**Do not use the supplied power cord with devices other than this projector.**

- Using the supplied power cord with devices other than this projector may cause short circuits or overheating, and result in electric shock or fire.

**Remove the depleted batteries from the remote control promptly.**

- Leaving them in the unit may result in fluid leakage, overheating, or explosion of the batteries.

**CAUTION:**

■ **POWER**

**When disconnecting the power cord, be sure to hold the power plug and power connector.**

If the power cord itself is pulled, the lead will become damaged, and fire, short-circuits or serious electric shocks will result.

**When not using the projector for an extended period of time, disconnect the power plug from the wall outlet and remove the batteries from the remote control.**

**Disconnect the power plug from the wall outlet before carrying out any cleaning and replacing the unit.**  
Electric shocks can result if this is not done.

## Read this first!

### CAUTION:

#### ■ ON USE/INSTALLATION

**Do not put your weight on this projector.**

You could fall or the projector could break, and injury will result.

- Be especially careful not to let young children stand or sit on the projector.

**Do not place the projector in extremely hot locations.**

Doing so will cause the outer casing or internal components to deteriorate, or result in fire.

- Take particular care in locations exposed to direct sunlight or near stoves.

**Always disconnect all cables before moving the projector.**

Moving the projector with cables still attached can damage the cables, which will cause fire or electric shocks to occur.

**Never plug headphones and earphones into AUDIO OUT jack.**

Excessive sound pressure from earphones and headphones can cause hearing loss.

#### ■ ACCESSORIES

**Do not use the old lamp unit.**

If used it could cause lamp explosion.

**If the lamp has broken, ventilate the room immediately. Do not touch or bring your face close to the broken pieces.**

Failure to observe this will cause the user to absorb the gas which was released when the lamp broke and which contains nearly the same amount of mercury as fluorescent lamps, and the broken pieces will cause injury.

- If you believe that you have absorbed the gas or that the gas has got into your eyes or mouth, seek medical advice immediately.
- Ask your dealer about replacing the lamp unit and check the inside of the projector.



### To remove the battery

Remote Control Battery

**1. Press the guide and lift the cover.**

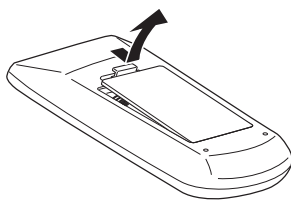

**2. Remove the batteries.**

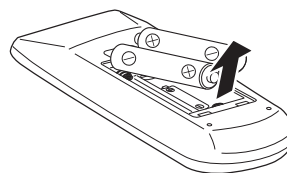

#### Trademarks

- HDMI, the HDMI logo and High-Definition Multimedia Interface is a trademark or registered trademark of HDMI Licensing LLC.

**HDMI**  
HIGH-DEFINITION MULTIMEDIA INTERFACE

- PJLink™ is a trademark or pending trademark in Japan, the United States, and other countries and regions.
- Other names, company names or product names used in these operating instructions are the trademarks or registered trademarks of their respective holders.

Please note that the operating instructions do not include the ® and ™ symbols.

#### Illustrations in these operating instructions

- Note that illustrations of the projector and screens may differ from the ones you actually see.

#### Page references

- In these instructions, references to pages are indicated as: (➡ page 00).

#### Term

- In these instructions, the “Wireless remote control unit” accessory is referred to as the “Remote control”.

## Auto Setup Function

- ▶ This function enables Input search, Auto Keystone correction and Auto PC adjustment by pressing the <AUTO SETUP> button.

## Direct Power Off Function

- ▶ With the Direct Power Off function, you can disconnect the power cord from the wall outlet or turn off the breaker even during projection.

## Improved connectivity

- ▶ The inclusion of an HDMI terminal provides support for high quality video and HDMI audio.

## Useful Functions for Presentations

- ▶ The digital zoom function allows you to focus on the crucial information during a presentation.
- ▶ The MIC function and 10W audio output allows you to make a presentation without any external audio equipment.

## Quick steps

For details, see the corresponding pages.

1. **Set up your projector.**  
(⇒ page 19)



2. **Connect with other devices.**  
(⇒ page 22)



3. **Connect the power cord.**  
(⇒ page 23)



4. **Power on.**  
(⇒ page 25)



5. **Select the input signal.**  
(⇒ page 28)



6. **Adjust the image.**  
(⇒ page 28)

# Contents

Be sure to read "Read this first!". (➔ pages 2 to 6)

## Important Information

<b>Read this first!</b> .....	<b>2</b>
<b>Contents</b> .....	<b>8</b>
<b>Precautions for Use</b> .....	<b>10</b>
Cautions when transporting.....	10
Cautions when installing.....	10
Security .....	11
Disposal.....	11
Cautions on use .....	12
Accessories .....	13
Optional accessories .....	14

## Preparation

<b>About Your Projector</b> .....	<b>15</b>
Remote control .....	15
Projector body .....	16
Control panel .....	17
Rear terminals .....	17
<b>Using Remote control</b> .....	<b>18</b>
Installing and Removing batteries .....	18
Setting Remote control ID numbers .....	18

## Getting Started

<b>Setting up</b> .....	<b>19</b>
Projection method .....	19
Parts for ceiling mount (Optional).....	19
Screen size and throw distance .....	20
Adjusting front adjustable feet .....	21
<b>Connections</b> .....	<b>22</b>
Before connecting to the projector .....	22
Connecting example.....	22

## Basic Operation

<b>Powering ON/OFF</b> .....	<b>23</b>
Connecting the power cord .....	23
POWER indicator .....	24
Turning On the Projector .....	25
Enter a PIN code .....	26
Turning Off the Projector .....	27
<b>Projecting</b> .....	<b>28</b>
Selecting the image.....	28
How to adjust the state of the image.....	28
<b>Basic operations by using the remote control</b> .....	<b>29</b>

Using the AUTO SET function .....	29
Switching the input signal .....	29
Using the SCREEN button .....	29
Using the KEYSTONE button.....	30
Using the INFO. button.....	30
Using the FREEZE function .....	30
Using the AV MUTE function .....	31
Using the P-TIMER button .....	31
Using the LAMP button .....	31
Using the D.ZOOM buttons .....	31
Controlling the volume of the speaker.....	31
Using the IMAGE button.....	32
Using the MUTE button .....	32

## Settings

<b>Menu Navigation</b> .....	<b>33</b>
Navigating through the menu .....	33
Main menu.....	34
Sub menu .....	34
<b>Input menu</b> .....	<b>36</b>
Computer 1: RGB/Component /RGB (Scart) .....	36
Computer 2: RGB.....	36
HDMI .....	36
Video .....	36
S-video .....	36
<b>Auto PC adjust</b> .....	<b>38</b>
Auto PC adj. ....	38
<b>Manual PC adjust</b> .....	<b>39</b>
Fine sync .....	39
Total dots .....	39
Horizontal .....	39
Vertical.....	39
Current mode .....	40
Clamp .....	40
Display area H.....	40
Display area V .....	40
Reset .....	40
Mode free .....	40
Store .....	40
<b>Image select</b> .....	<b>41</b>
Dynamic .....	41
Standard.....	41
Real .....	41
Cinema .....	41
Blackboard(Green).....	41
Colorboard.....	41
Image 1-4 .....	41
<b>Image adjust</b> .....	<b>42</b>
Contrast.....	42
Brightness .....	42

Color.....	42
Tint .....	42
Color temp.....	42
Red .....	43
Green .....	43
Blue .....	43
Sharpness .....	43
Gamma.....	43
Noise reduction .....	43
Progressive .....	44
Reset.....	44
Store.....	44
Normal.....	45
Full .....	45
Wide(16:9).....	45
Zoom .....	45
True .....	45
Custom .....	45
<b>Screen .....</b>	<b>45</b>
Custom adj. ....	46
Digital zoom + .....	46
Digital zoom - .....	46
Keystone .....	46
Ceiling .....	47
Rear.....	47
Reset.....	47
<b>Sound .....</b>	<b>48</b>
Volume .....	48
Mute .....	48
MIC .....	48
MIC gain .....	48
Standby MIC out.....	48
<b>Setting .....</b>	<b>49</b>
Language .....	49
Menu position.....	49
Auto setup .....	49
Background .....	50
Display.....	50
Logo .....	50
HDMI setup .....	51
Terminal.....	51
Power management .....	51
Direct on.....	52
Standby mode .....	52
P-timer.....	52
Closed caption.....	53
Lamp power.....	53
Remote control .....	53
Security .....	53
Fan .....	54
Fan control .....	54
Video delay control.....	55

Filter counter .....	55
Total power savings.....	55
Warning log .....	55
Factory default.....	55

## Information..... 56

Input Source Information Display .....	56
--	----

## Network ..... 57

Projector name .....	57
Network setup .....	57
Network control .....	58
Network status.....	58
AMX D.D. ....	58
Network factory default.....	58
Network connections .....	59
Computer operation.....	60
Accessing from the Web browser.....	60

## Maintenance

### LAMP REPLACE and WARNING

#### Indicators..... 71

Managing the indicated problems .....	71
---------------------------------------	----

#### Replacement..... 72

Before replacing the unit .....	72
Maintenance.....	72
Replacing the unit.....	72
Attaching the Lens Cap .....	76

#### Troubleshooting ..... 77

## Appendix

### Technical Information ..... 79

PJLink protocol.....	79
Control commands via LAN.....	80
Serial terminal .....	82
Other terminals.....	85
List of compatible signals .....	86

### Specifications ..... 90

Dimensions.....	92
-----------------	----

### Ceiling mount bracket safeguards..... 92

### Index ..... 93

# Precautions for Use

## Cautions when transporting

- When transporting the projector, hold it securely by its bottom and avoid excessive vibration and impacts. Doing so may damage the internal parts and result in malfunctions.
- Do not transport the projector with the adjustable feet extended. Doing so may damage the adjustable feet.

## Cautions when installing

### ■ Do not set up the projector outdoors.

- The projector is designed for indoor use only.

### ■ Do not use under the following conditions.

- Places where vibration and impacts occur such as in a car or vehicle: Doing so may damage the internal parts and result in malfunctions.
- Near the exhaust of an air conditioner or near lights (studio lamps, etc.) where temperature changes greatly (Operating environment ►page 91): Doing so may shorten the life of the lamp or result in deformation of the outer case and malfunctions.
- Near high-voltage power lines or near motors: Doing so may interfere with the operation of the projector.

### ■ Be sure to ask a specialized technician when installing the product to a ceiling.

This requires an optional ceiling mount bracket.

Model No.: ET-PKV100H (for high ceilings), ET-PKV100S (for low ceilings),  
ET-PKV100B (Projector Mount Base).

### ■ When using the projector in the elevation of below 1 200 m, make sure [Fan control] is set to [Off].

Failure to do so may shorten the life of the internal parts and result in malfunctions.

### ■ When using the projector in the elevation of above 1 200 m and below 2 000m, make sure [Fan control] is set to [On 1].

Failure to do so may shorten the life of the internal parts and result in malfunctions.

### ■ When using the projector in the elevation of above 2 000 m and below 2 700m, make sure [Fan control] is set to [On 2].

Failure to do so may shorten the life of the internal parts and result in malfunctions.

### ■ Do not install the projector at elevations of 2 700 m (8 858 ft) or higher above sea level.

Failure to do so may shorten the life of the internal parts and result in malfunctions.

### ■ Do not tilt the projector or place it on its side.

Do not tilt the projector body more than approximately  $\pm 40$  degrees vertically or  $\pm 20$  degrees horizontally. Over tilting may result in shortening the life of the components.

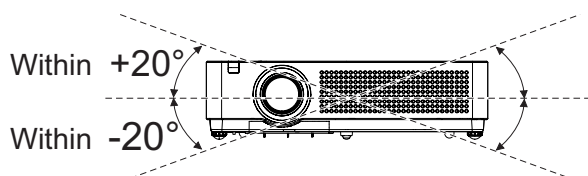
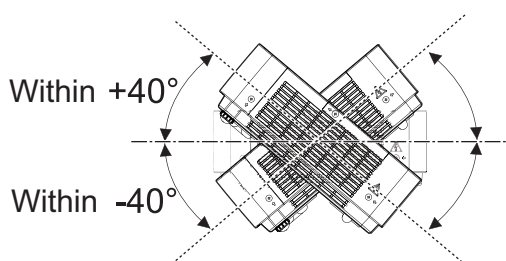

## Cautions when setting the projectors

- Do not stack the projectors.
- Do not block the ventilation ports (intake and exhaust) of the projector.
- Avoid heating and cooling air from the air conditioning system directly blow to the ventilation ports (intake and exhaust) of the projector.

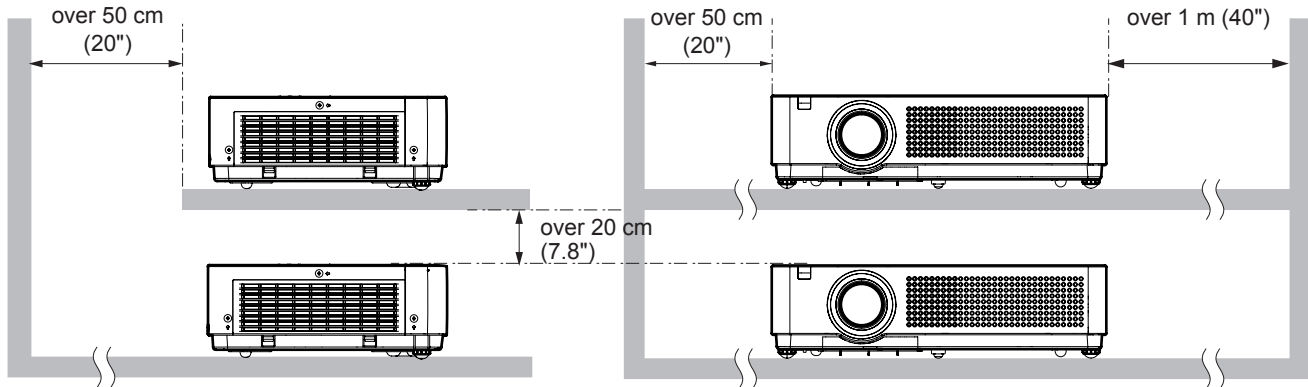
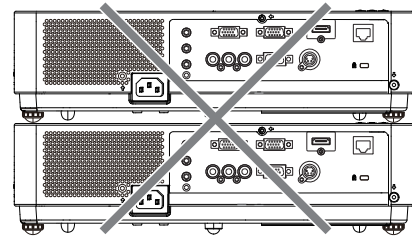

- Do not place the projector in an enclosed space.  
If you need to place the projector in an enclosed space, additional air conditioning and ventilation system must be equipped. When ventilation is insufficient, remaining heat may trigger the protection circuit of the projector.

## Security

### Take safety measures against following incidents.

- Personal information being leaked via this product.
- Unauthorized operation of this product by a malicious third party.
- Interfering or stopping of this product by a malicious third party.

### Security instruction (➔ pages 53, 70 )

- Make your password as difficult to guess as possible.
- Change your password periodically.
- Panasonic or its affiliate company never inquires a password directly to a customer. Do not tell your password in case you receive such an inquiry.
- The connecting network must be secured by firewall or others.
- Set a password for web control and restrict the users who can log in.

## Disposal

When disposing of the product, ask your local authority or dealer about the correct methods of disposal. The lamp contains mercury. When disposing of the used lamp unit, ask your nearest local authorities or dealer about proper disposal of the unit. Dispose of used batteries according to the instructions or your local disposal rule or guidelines.



# Precautions for Use

## Cautions on use

### ■ In order to get the picture quality

- Draw curtains or blinds over windows and turn off any lights near the screen to prevent outside light or light from indoor lamps from shining onto the screen.
- Depending on where the projector is used, heated air from an exhaust port or warm or cold air from an air conditioner can cause a shimmering effect on screen.  
Avoid use in locations where exhaust or streams of air from projector, other devices and air conditioners flow between the projector and the screen.
- The lens of projector is affected by the heat from the luminous source. Because of this, the focusing may not be stable right after the power is turned on. Focusing is stabilized after projecting image for 30 minutes and longer.

### ■ Do not touch the surface of the projector lens with your bare hand.

If the surface of the lens becomes dirty from fingerprints or anything else, this will be magnified and projected onto the screen.

### ■ LCD Panel

The display unit of this projector comprises three LCD panels. Although an LCD panel is a product of high-precision technology, some of the pixels on the projected image may be missing or constantly lit. Please note that this is not a malfunction.

Displaying a still image for a longer time may result in an after-image on the LCD panels. If this happens, display the all white screen in the test pattern for an hour or more.

### ■ Optical components

Operating the projector in an environment with high temperature or heavy exposure to dust or tobacco smoke will reduce the service life of the optical components, such as the LCD panel and polarizing plate, and may necessitate their replacement within less than one year of use. For details, consult your dealer.

### ■ Lamp

The luminous source of the projector is a mercury lamp with high internal pressure.

A high pressure mercury lamp has following characteristics.

- The brightness of the lamp will decrease by duration of usage.
- The lamp may burst with sound or shorten life by shock or chipping.
- The life of the lamp varies greatly depending on individual specificities and usage conditions. In particular, continuous use over 12 hours and frequent on/off switching of the power greatly deteriorate the lamp and affect the lamp life.
- In rare cases, the lamp burst shortly after the projection.
- The risk of bursting increases when the lamp is used beyond its replacement cycle. Make sure to replace the lamp unit consistently. ("When to replace the lamp unit" (➡ page 74))
- If the lamp bursts, gas contained inside of the lamp is released in a form of smoke.
- It is recommended to store replacement lamps for contingency.
- It is recommended to have authorized engineer or your dealer replace the lamp unit.

Pursuant to at the directive 2004/108/EC, article 9(2)

Panasonic Testing Centre





Panasonic Service Europe, a division of Panasonic Marketing Europe GmbH

Winsbergring 15, 22525 Hamburg, F.R. Germany

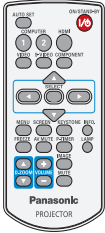
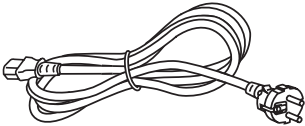

## Accessories

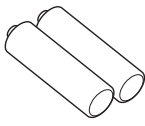
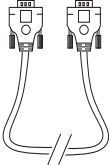
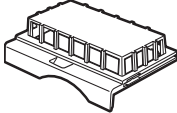
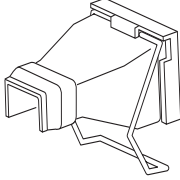
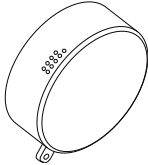
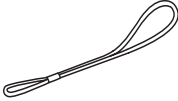
Make sure the following accessories are provided with your projector. Numbers in the brackets ( ) show the number of accessories.

Remote control unit (x1) (6451048738)	Power cord (x1) (6103580203)	CD-ROM (x1) (6103609515)	Batteries (AAA/R03 or AAA/LR03 type) (x2)
			 (for remote control unit)
RGB signal cable (x1) (6103580425)	Filter cover (x1) (6103568881)	AC power cord holder (x1) (6103573700) (6103573694)	Lens cap (x1) (6103527222)
			 (Attached to the projector at the time of purchase.)
String (x1) (6103430249)	Soft Carrying Case (x1) (6103581620)		
			

### Attention

- After unpacking the projector, discard the power cord cap and packaging material properly.
- For lost accessories, consult your dealer.
- The part numbers of accessories and separately sold components are subject to change without notice.
- Store small parts in an appropriate manner, and keep them away from young children.

## Precautions for Use

### ■ Contents of CD-ROM

The following contents are stored on the supplied CD-ROM.

Instructions/List (PDF)	Software
<ul style="list-style-type: none"><li>● <b>Operating Instructions – Functional Manual</b></li><li>● <b>Operation Manual Multi Projector Monitoring &amp; Control Software 2.6</b></li><li>● <b>Operation Manual Logo Transfer Software 2.0</b></li><li>● <b>List of compatible projector models</b><ul style="list-style-type: none"><li>• This is a list of projectors that are compatible with the software (refer to the right column), and their restrictions.</li></ul></li></ul>	<ul style="list-style-type: none"><li>● <b>Multi Projector Monitoring &amp; Control Software 2.6 (Windows)</b><ul style="list-style-type: none"><li>• This software allows you to monitor and control multiple projectors connected to the LAN.</li></ul></li><li>● <b>Logo Transfer Software 2.0 (Windows)</b><ul style="list-style-type: none"><li>• This software allows you to create original images, such as company logos to be displayed when projection starts, and transfer them to the projector.</li></ul></li></ul>

## Optional accessories

Options	Model No.
<b>Ceiling Mount Bracket</b>	ET-PKV100H (for high ceilings), ET-PKV100S (for low ceilings)
<b>Projector Mount Base</b>	ET-PKV100B
<b>Replacement Lamp Unit</b>	ET-LAV100
<b>Replacement Filter Unit</b>	ET-RFV100

# About Your Projector

## Remote control

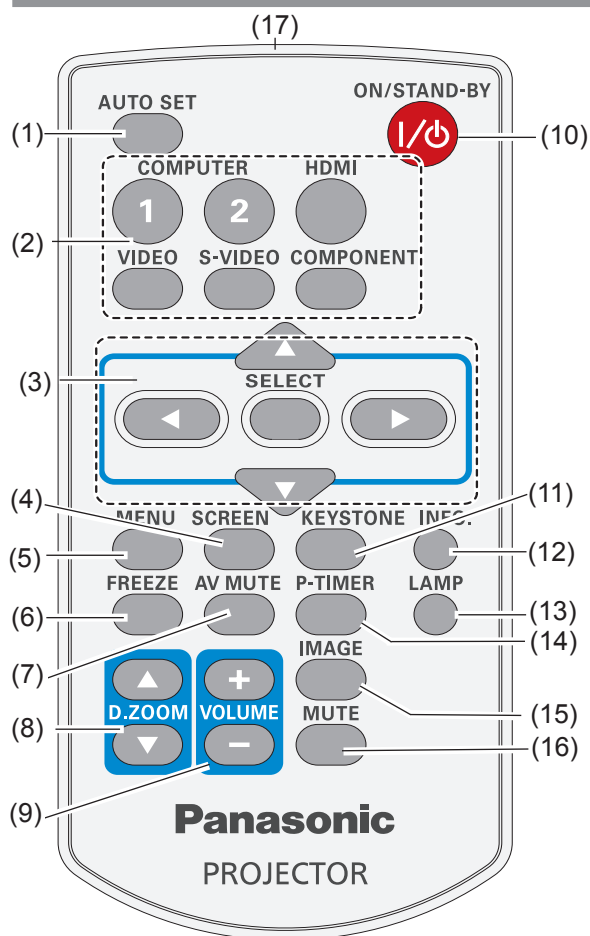

### (1) <AUTO SET> Button

Execute the setting of Auto setup in the setting menu. (➔page 49)

### (2) Input Selection Buttons: <COMPUTER 1>, <COMPUTER 2>, <HDMI>, <VIDEO>, <S-VIDEO>, <COMPONENT>.

These buttons are used to select the input signal. (➔page 29)

### (3) ▲ ▼ ◀ ▶ Buttons, <SELECT> Button

Navigate the MENU display. (➔page 33)

### (4) <SCREEN> Button

Select a screen mode. (➔page 45)

### (5) <MENU> Button

Open or close the On-Screen Menu. (➔page 33)

### (6) <FREEZE> Button

Pauses the projected image and sound tentatively. (➔page 30)

### (7) <AV MUTE> Button

Temporarily turn off the image on the screen. (➔page 31)

### (8) <D.ZOOM ▲ ▼> Buttons

Zoom in and out the images.

### (9) <VOLUME +/-> Buttons

Adjusts the volume of the speaker. (➔page 31)

### (10) <ON/STAND-BY> Button

Turn the projector on or off. (➔page 25)

### (11) <KEYSTONE> Button

Correct keystone distortion. (➔page 30)

### (12) <INFO.> Button

Operate the information function. (➔page 30)

### (13) <LAMP> Button

Select a lamp mode. (➔page 31)

### (14) <P-TIMER> Button

Operate the P-timer function. (➔page 31)

### (15) <IMAGE> Button

Select the image mode. (➔page 32)

### (16) <MUTE> Button

Mute the sound. (➔page 32)

### (17) Remote control signal emitter

#### Attention

- Do not drop the remote control.
- Avoid contact with liquids.
- Do not attempt to modify or disassemble the remote control.

#### Note

- The remote control can be used within a distance of about 5 m (16.4 ft) if pointed directly at the remote control signal receiver. The remote control can control at angles of up to  $\pm 30^\circ$  vertically and  $\pm 30^\circ$  horizontally, but the effective control range may be reduced.
- If there are any obstacles between the remote control and the remote control signal receiver, the remote control may not operate correctly.
- You can operate the projector by reflecting the remote control signal on the screen. The operating range may differ due to the loss of light caused by the properties of the screen.
- When the remote control signal receiver is lit with a fluorescent light or other strong light source, the projector may become inoperative. Set the projector as far from the luminous source as possible.

# About Your Projector

## Projector body

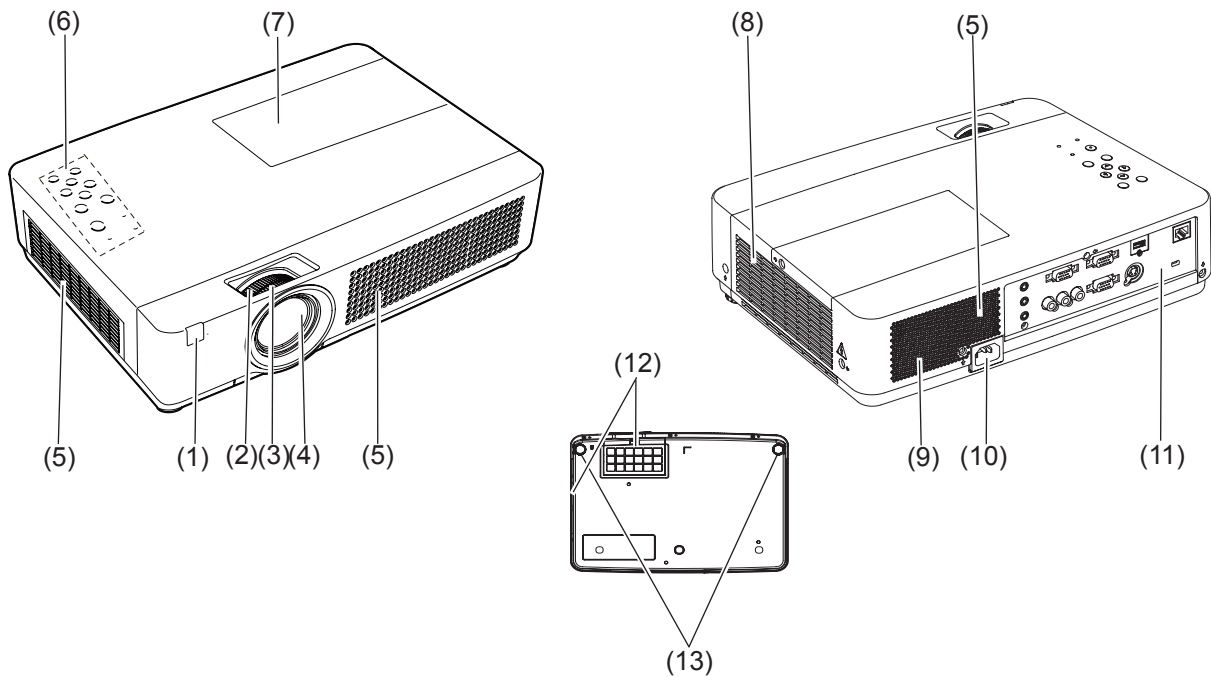

**(1) Remote control signal receiver**

**(2) Zoom Ring**

Adjust the zoom.

**(3) Focus Ring**

Adjust the focus.

**(4) Projection Lens**

**(5) Air intake port**

**(6) Control Panel and Indicators** (➔page 17)

**(7) Lamp cover** (➔page 75)

The lamp unit is located inside.

**(8) Air outlet port**

- Hot air is exhausted from the exhaust vent. Do not put heat-sensitive objects near this side.

**(9) Speaker**

**(10) AC IN**

**(11) Terminals** (➔page 17)

**(12) Air filter cover** (➔page 72)

**(13) Adjustable feet**

Adjust the projection angle.

### WARNING:

- **Keep your hands and other objects away from the air exhaust port.**
- Keep your hand and face away.
- Do not insert your finger.
- Keep heat-sensitive articles away.

Heated air from the air exhaust port can cause burns or external damage.

## Control panel

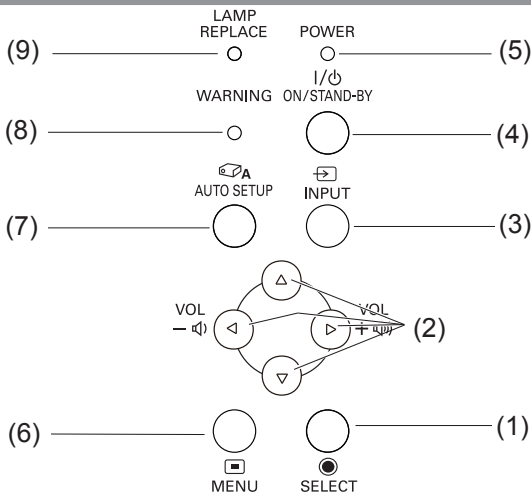

### (1) <SELECT> button

Execute the selected item.

### (2) ▲ ▼ ◀ ▶ (VOL +/-) buttons

Navigate the MENU screen.

Adjust the volume level (with <VOL +/-> buttons). (➔page 31)

### (3) <INPUT> button

Selects the input signal. (➔page 28)

### (4) <ON/STAND-BY> button

Turn the projector on/off.

### (5) <POWER> indicator

Indicate the power status.

### (6) <MENU> button

Displays the MENU screen. (➔page 33)

### (7) <AUTO SETUP> button

Execute the setting of Auto setup in the setting menu.

### (8) <WARNING> indicator

Indicate the abnormal conditions of the projector.

### (9) <LAMP REPLACE> indicator

Lights yellow when the projection lamp reaches its end of life.

## Rear terminals

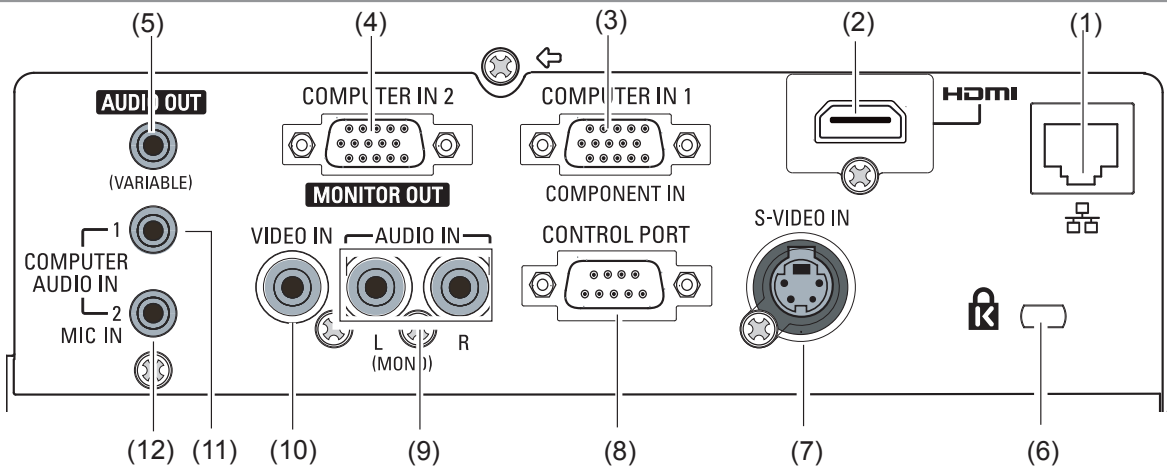

### (1) LAN

Connect to a LAN cable for network connection.

### (2) HDMI

Connect to HDMI input signals.

### (3) COMPUTER IN 1/ COMPONENT IN

Connect to COMPUTER IN 1/ COMPONENT IN input signals.

### (4) COMPUTER IN 2/ MONITOR OUT

Connect to COMPUTER IN 2/ MONITOR OUT input signals or outputs the analog RGB signals input the projector.

### (5) AUDIO OUT (VARIABLE)

Output the audio signals input to the projector.

### (6) Security slot

Attach the commercial shackle lock, manufactured by Kensington, to protect your projector. Compatible with the Kensington MicroSaver Security System.

### (7) S-VIDEO IN

Connect to S-VIDEO input signals.

### (8) CONTROL PORT

Connect to a computer via an RS-232C cable.

### (9) AUDIO IN

Connect to the audio input signals. AUDIO IN has right and left (L and R) terminals. For a mono audio signal (a single audio jack), connect it to the L (MONO) jack.

### (10) VIDEO IN

Connect to VIDEO input signals.

### (11) COMPUTER AUDIO IN 1

Connect to the audio input signals.

### (12) COMPUTER AUDIO IN 2 (MIC IN)

Connect to the audio input signals. Or connect the MIC to this jack.

### Attention

- When a LAN cable is directly connected to the projector, the network connection must be made indoors.

# Using Remote control

## Installing and Removing batteries

### 1) Open the cover

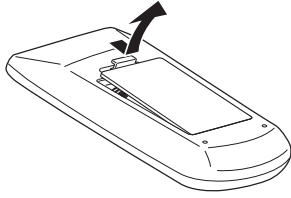

### 2) Install batteries and close the cover (Insert the – side first.)

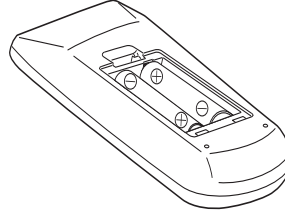

- Remove the batteries in the reverse order of installation.

## Setting Remote control ID numbers

When you use the system with multiple projectors, you can operate all the projectors simultaneously or each projector individually using single remote control, if unique ID number is assigned to each projector. After setting the ID number of the projector, set the same ID number to the remote control. There are 7 different ID codes (ALL, Code 1~Code 6), the initial ID number is [ALL].

### ■ Setting the ID number

- 1) While holding down the <MENU> button, press the <IMAGE> button. The number of times you press the <IMAGE> button corresponds to the desired ID code number.
- 2) The number of times to press the <IMAGE> button is as follows:  
Code 1= Once, Code 2= Twice, Code 3= 3 times, Code 4= 4 times  
Code 5= 5 times, Code 6= 6 times.
- 3) The ID code is changed when the <MENU> button is released.

### ■ Resetting the ID number

The ID code is reset to [ALL] (default) by pressing the <MENU> button and <IMAGE> button at the same time for 5 seconds or more.

#### Attention

- If the <IMAGE> button is pressed 7 times or more, the ID code cannot be changed (the operation is invalid).

#### Note

- For details, please refer to the [Remote control] of the [Setting] menu. (➡ page 53)

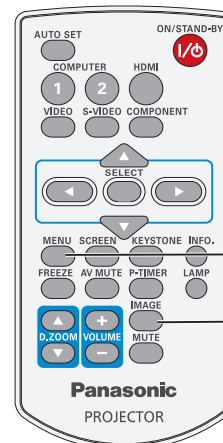

MENU button

IMAGE button

# Setting up

## Projection method

You can use the projector with any of the following 4 projection methods. To set the desired method in the projector.

### ■ Setting on a desk/floor and projecting forward

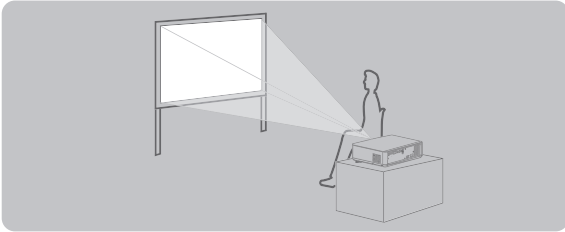

Menu setting\*1

Ceiling	Off
Rear	Off

### ■ Mounting on the ceiling and projecting forward

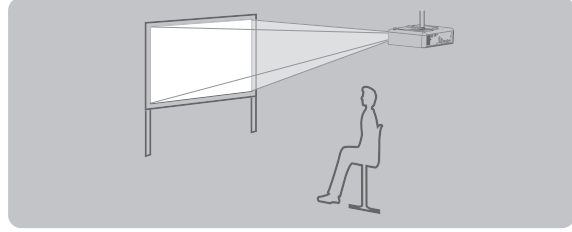

Menu setting\*1

Ceiling	On
Rear	Off

### ■ Mounting on the ceiling and projecting from rear

(Using translucent screen)

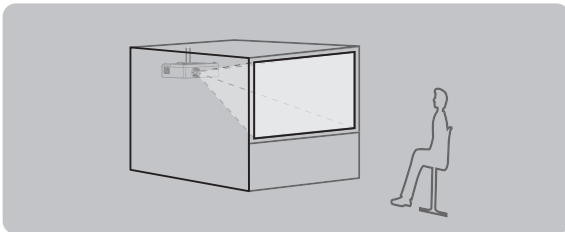

Menu setting\*1

Ceiling	On
Rear	On

### ■ Setting on a desk/floor and projecting from rear

(Using translucent screen)

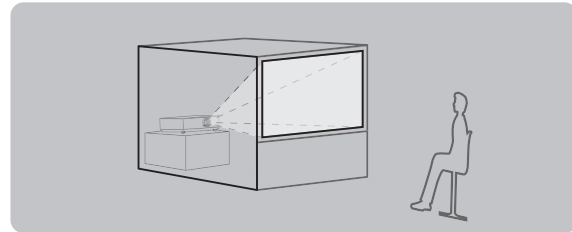

Menu setting\*1

Ceiling	Off
Rear	On

\*1 : For details about the menu setting, please refer to the [Screen] menu → [Ceiling] and [Rear]. (➡ page 47)

## Parts for ceiling mount (Optional)

You can install the projector on the ceiling by using the optional ceiling mount bracket (ET-PKV100H: for high ceiling, ET-PKV100S: for low ceiling), and the optional projector mount base ET-PKV100B.

- Use only the ceiling mount brackets specified for this projector.
- Refer to the installation manual for the ceiling mount bracket when you install the bracket and the projector.

### Attention

- To ensure projector performance and security, installation of the ceiling mount bracket must be carried by your dealer or a qualified technician.

# Setting up

## Screen size and throw distance

Place the projector referring to the diagram on the right and the figures of throwing distance. You can adjust the display size.

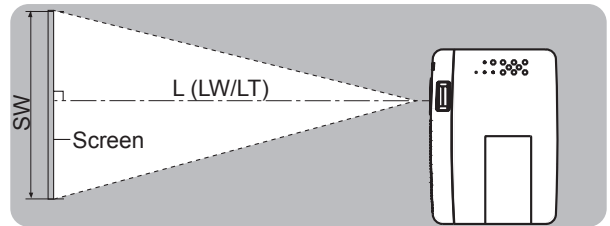
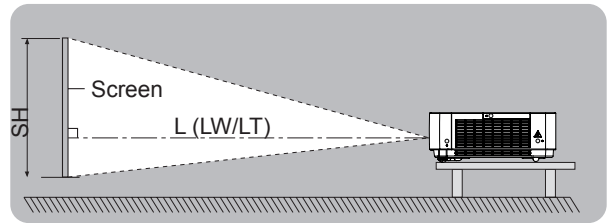
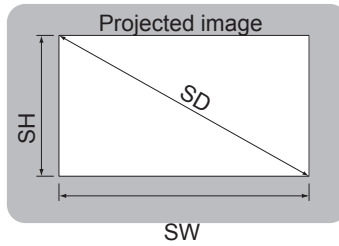

L (LW/LT) *1	Projection distance (m)
SH	Height of the projection area (m)
SW	Width of the projection area (m)
SD	Diagonal length of the projection area (m)

\*1 : LW : Minimum distance  
LT : Maximum distance

### Attention

- Before installing, please read "Precautions for Use" (➔ pages 10 to 14).

## Projection distance

(All measurements below are approximate and may differ slightly from the actual measurements.)

Projection size	For 4:3 aspect ratio		For 16:9 aspect ratio	
	Minimum distance (LW)	Maximum distance (LT)	Minimum distance (LW)	Maximum distance (LT)
1.02 m(40")	1.4 m(4.59')	1.7 m(5.58')	1.5 m(4.92')	1.8 m(5.91')
1.27 m(50")	1.7 m(5.58')	2.1 m(6.89')	1.9 m(6.23')	2.3 m(7.55')
1.52 m(60")	2.1 m(6.89')	2.5 m(8.20')	2.3 m(7.55')	2.8 m(9.19')
1.78 m(70")	2.5 m(8.20')	3.0 m(9.84')	2.7 m(8.86')	3.2 m(10.5')
2.03 m(80")	2.8 m(9.19')	3.4 m(11.15')	3.1 m(10.17')	3.7 m(12.14')
2.29 m(90")	3.2 m(10.5')	3.8 m(12.47')	3.5 m(11.48')	4.1 m(13.45')
2.54 m(100")	3.5 m(11.48')	4.2 m(13.78')	3.8 m(12.47')	4.6 m(15.09')
3.05 m(120")	4.2 m(13.78')	5.1 m(16.73')	4.6 m(15.09')	5.5 m(18.04')
3.81 m(150")	5.3 m(17.39')	6.4 m(21.00')	5.8 m(19.03')	6.9 m(22.64')
5.08 m(200")	7.1 m(23.29')	8.5 m(27.89')	7.7 m(25.26')	9.2 m(30.18')
6.35 m(250")	8.8 m(28.87')	10.6 m(34.78')	9.6 m(31.50')	11.6 m(38.06')
7.62 m(300")	10.6 m(34.78')	12.7 m(41.67')	11.6 m(38.06')	13.0 m(42.65')

Any other projection distance can be obtained according to the screen dimensions (m) using the following calculations.

The distance is shown in units of meters. (The calculated distance may contain a certain error.)

If the screen dimensions are written as "SD"

	For 4:3 aspect ratio	For 16:9 aspect ratio
Screen height (SH)	= SD(m) × 0.6	= SD(m) × 0.490
Screen width (SW)	= SD(m) × 0.8	= SD(m) × 0.872
Minimum distance (LW)	= 1.3937 × SD(m) - 0.0240	= 1.5184 × SD(m) - 0.0240
Maximum distance (LT)	= 1.6732 × SD(m) - 0.0242	= 1.8229 × SD(m) - 0.0242



## Adjusting front adjustable feet

The adjustable feet can be extended by turning it as shown in the figure. It is retracted by turning it in the opposite direction. (Projection angle can be adjusted vertically.)

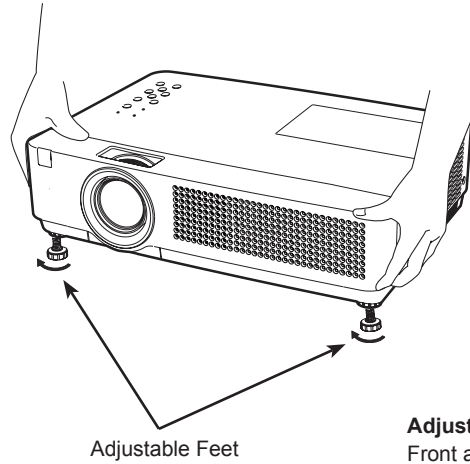
**Adjustable range**

Front adjustable feet : 41.2 mm(1.622")

**Attention**

- Heated air comes out of the air exhaust port while the lamp is lit. Do not touch the air exhaust port directly when you adjust the front adjustable feet.
- If keystone distortion occurs on the projected image, perform "KEYSTONE" from the "Screen" menu. (➡page 46)

# Connections

## Before connecting to the projector

- Read carefully the instruction manual for the device to be connected.
- Turn off the power switch of the devices before connecting cables.
- If any connection cable is not supplied with the device, or if no optional cable is available for connection of the device, prepare a necessary system connection cable to suit the device.
- Video signals containing too much jitter may cause the images on the screen to randomly wobble or wafture. In this case, a time base corrector (TBC) must be connected.
- The projector accepts the following signals: VIDEO, S-VIDEO, analogue-RGB (with TTL sync. Level) and digital signal.
- Some computer models are not compatible with the projector.
- When using long cables to connect with each of equipment to the projector, there is a possibility that the image will not be output correctly unless a compensator is used.
- For details on what video signals the projector supports, see “List of compatible signals”. (▶pages 86-89)

## Connecting example

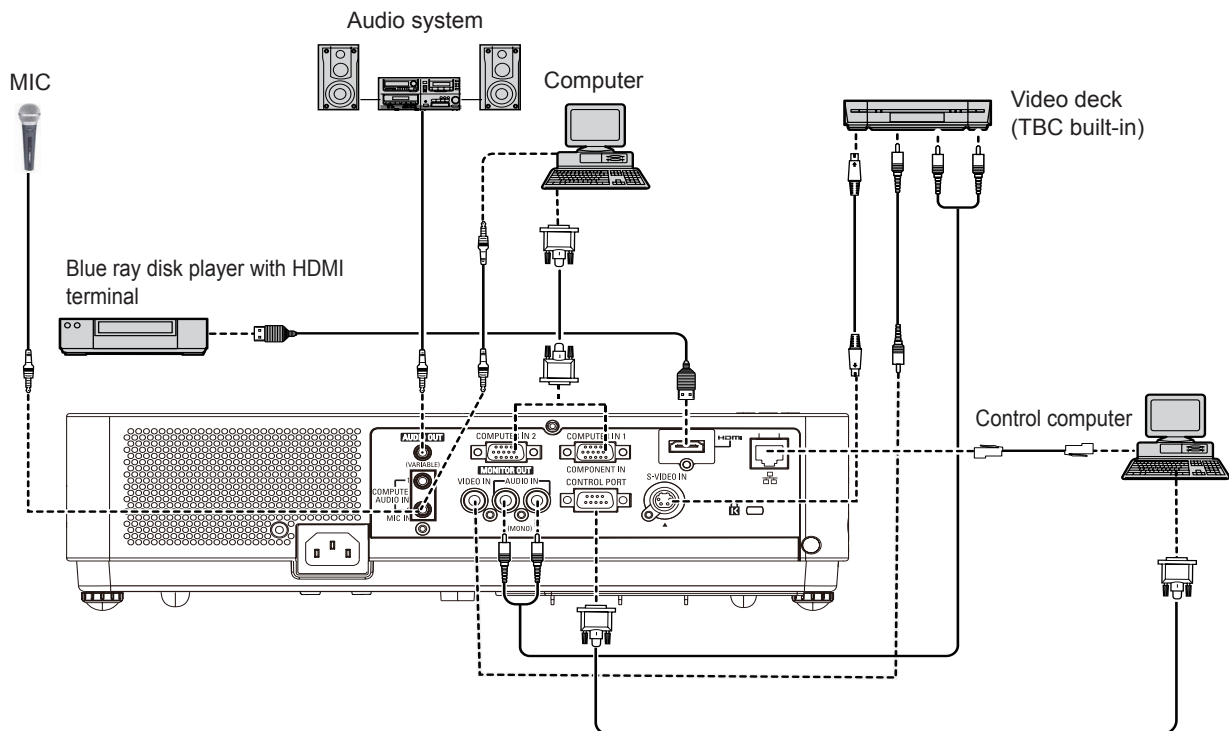

### Attention

- When connecting with a video deck, be sure to use the one with a built-in time base corrector (TBC) or use a TBC between the projector and the video deck.
- If nonstandard burst signals are connected, the image may be distorted. If this is the case, connect a TBC between the projector and the video deck.

### Note

- When using an HDMI cable, check that it is compliant with the HDMI standard. Using a cable that is not compliant with the HDMI standard may result in problems such as the image cutting out or not appearing. When connecting the 1 080p signal using HDMI, use a cable compliant with 1 080p signal.
- This projector does not support the Viera link (HDMI).
- For the specifications of the RGB signals that can be applied from the PC, refer to “List of compatible signals”. (▶pages 86-89)
- See [Network] in this instruction manual for the details of wired LAN communication between the projector and the computer.

# Powering ON/OFF

## Connecting the power cord

Be sure to insert the attached power cord securely to its base to prevent it from coming off.

### ■ Power cord holder

A power cord holder is designed to prevent the AC power cord from coming off the projector. Please insert the power cord into the power cord holder correctly as Picture (1) shown:

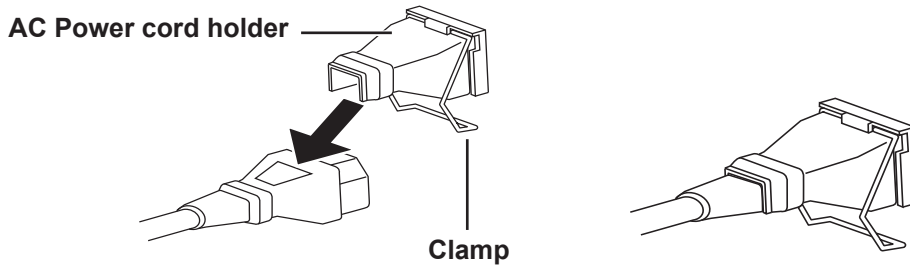

Picture (1)

### ■ Attaching

Attach the AC power cord with the power cord clamp to the projector by following these steps.

- 1) Plug the power cord with the power cord holder to the projector as Picture (2) shown.
- 2) Push the clamp at the AC Power cord holder downward to secure it to the projector. It is correctly attached until you hear the "CLICK" sound. See Picture (3) for correct attachment.

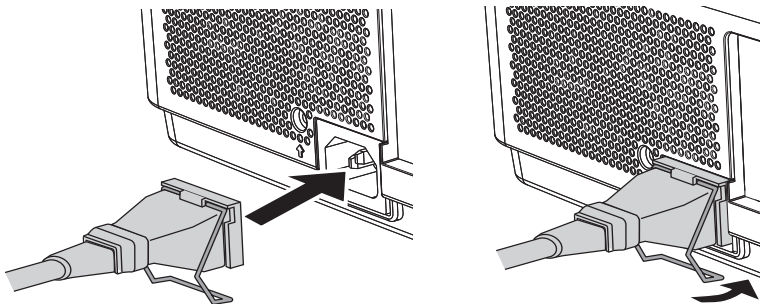

Picture (2)

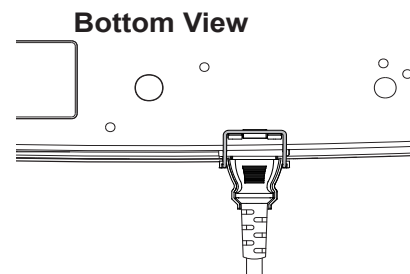

Picture (3)

# Powering ON/OFF

## POWER indicator

The power indicator informs you the status of the power. Confirm the status of the <POWER> indicator before operating the projector.

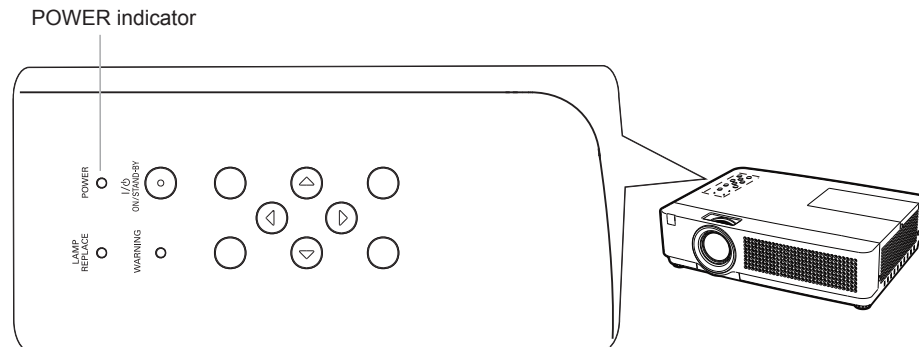

Indicator status		Status
No illumination or flashing		The power cord is unplugged.
RED	Lit	The power cord is plugged.
		The projector is in stand-by mode, after the cooling is completed.
	Flashing	The projector is cooling down. The projector cannot be turned on until cooling is completed and the <POWER> indicator stops blinking.
The temperature inside the projector is abnormally high and the projector is cooling down. And the <WARNING> indicator also blinks in red (►page 71). The projector cannot be turned on until cooling is completed and the <POWER> indicator stops blinking.		
GREEN	Lit	Projecting.
	Flashing	The projector is in stand-by status with [Power management] function. The projection lamp will be turned on if the input signal is reconnected or any button on the control panel or remote control is pressed. (►page 51)

## Turning On the Projector

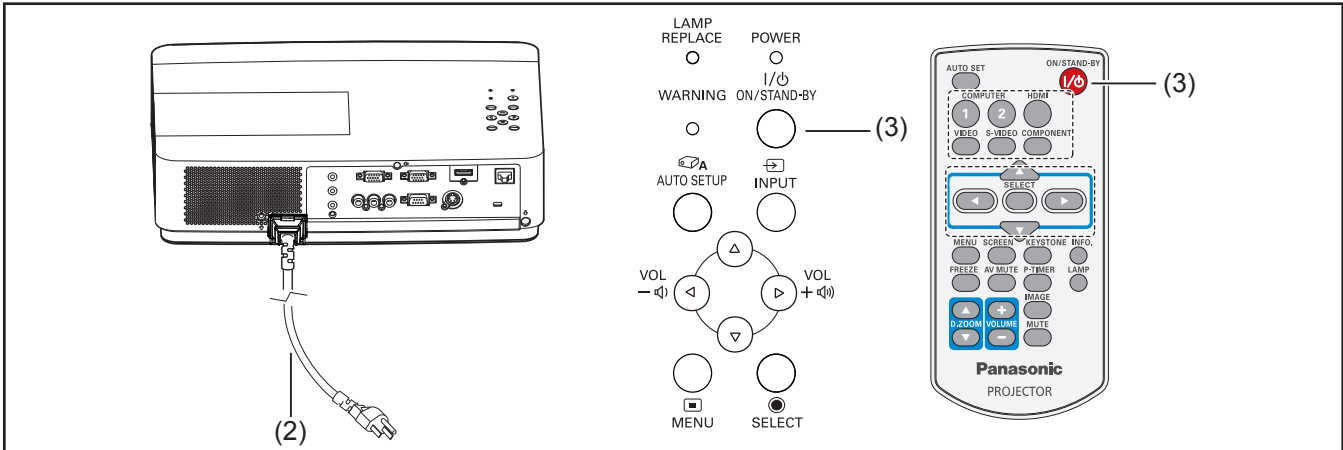

- 1) Complete peripheral connections (with a computer, VCR, etc.) before turning on the projector.
- 2) Connect the projector's AC power cord into an AC outlet. The <POWER> indicator lights red. Open the lens cap.
- 3) Press the <ON/STAND-BY> button on the control panel or on the remote control. The <POWER> indicator lights green and the cooling fans start to operate. The preparation display appears on the screen and the count down starts.
- 4) After the countdown, the input source that was selected the last time and the lamp power status icon appear on the screen.
- 5) If there is no signal input when start on the projector, or the current signal is missed while operating the projector, the Video/Computer selection window will be displayed on the screen, please move the pointer to input source desired by pressing the ▲▼ and the <SELECT> button. And then follow the input signal guidance window to correct the signal and connection.

If the projector is locked with a PIN code, PIN code input dialog box will appear. Enter the PIN code as instructed on the next page.

### Note

- When the [Logo select] function is set to [Off], the logo will not be shown on the screen (➡ page 50).
- When [Countdown off] or [Off] is selected in the [Display] function, the preparation display will not be shown on the screen (➡ page 50).
- When the [Input search] function is set to [On 2], the input signal will be searched automatically (➡ page 49).
- When the [Direct on] function is set to [On], the projector will be turned on automatically by connecting the AC power cord to an AC outlet.

### Preparation display

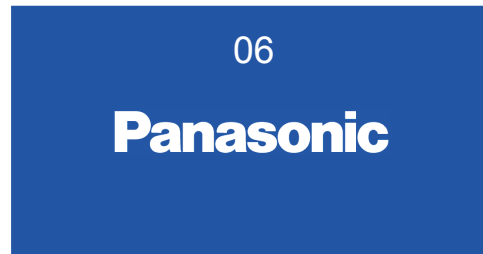

The preparation display will disappear after 30 seconds.

### Initial display

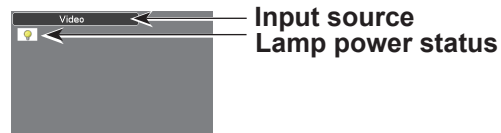

### Video/Computer selection



# Powering ON/OFF

## Enter a PIN code

Press ▲▼ to enter a number. Press ► to fix the number and move the red frame pointer to the next box. The number changes to \*. If you fixed an incorrect number, use the ◀ button to move the pointer to the number you want to correct, and then enter the correct number.

Repeat this step to complete entering a four-digit number.

After entering the four-digit number, move the pointer to "Set". Press the <SELECT> button so that you can start to operate the projector.

If you entered an incorrect PIN code, PIN code and the number (\*\*\*\*) will turn red for a moment. Enter the correct PIN code all over again.

### Note

- If the PIN code number is not entered or wrong PIN code number is entered within three minutes after the PIN code dialog box appeared, the projector will be turned off automatically.
- The "1234" is set as the initial PIN code at the factory.

### PIN Code Input Dialog Box

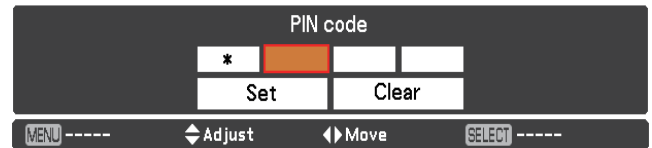

After the OK icon disappears, you can operate the projector.

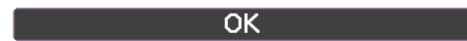

## Turning Off the Projector

- 1) Press the <ON/STAND-BY> button on the control panel or on the remote control, and **Power off?** appears on the screen.
- 2) Press the <ON/STAND-BY> button again to turn off the projector. The <POWER> indicator starts to blink red, and the cooling fans keep running. At this time, you can unplug the AC power cord even if the fans are still running.
- 3) When the projector has cooled down enough, the <POWER> indicator stops blinking and you can turn on the projector.

### Note

- Do not put the projector in a case before the projector is cooled enough.
- While the <POWER> indicator is blinking, the lamp is being cooled down and the projector cannot be turned on. Wait until the <POWER> indicator stops blinking to turn on the projector again.
- The projector can be turned on after the <POWER> indicator turns red. The waiting time to restart will be shortened when the normal power-off processing for fan cooling is completed, compared with the time the AC power cord is immediately unplugged after the power-off.

## Direct Power Off function

You can disconnect the power cord from the wall outlet or turn off the breaker even during projection without pressing the <ON/STAND-BY> button.

### Note

- The cooling fans will continue to rotate using internally stored power.
- When using the [Direct power Off] function, you can not restart the projector immediately after the power is disconnected. The lamp remains high temperature and needs to be cooled, so it sometimes takes longer time than usual for the lamp to light up again.

Power off ?

**Power off?** disappears after 4 seconds.

# Projecting

Check the connections of the peripheral devices and connection of the power cord (➔page 23) and switch on the power (➔page 25) to start the projector. Select the image and adjust the state of the image.

## Selecting the image

Select an input signal.

The image selected with the <COMPUTER 1>, <COMPUTER 2>, <HDMI>, <VIDEO>, <S-VIDEO>, or <COMPONENT> button is projected (➔page 29).

### Attention

- Images may not be projected properly depending on the connected device and DVD, video tape, etc. to be played. Select a system format that is suitable for the input signal in [Component] or [RGB] in the [Input] menu (➔page 36).
- Check the aspect ratio of the screen and the image and select the optimum aspect ratio under the [Screen] menu (➔page 45).

## How to adjust the state of the image

### 1) Adjust the projection angle.

- For details, see “Adjusting front adjustable feet” (➔page 21).

### 2) Adjust the zoom and the focus.

Turn [Zoom ring] and [Focus ring] to adjust the image.

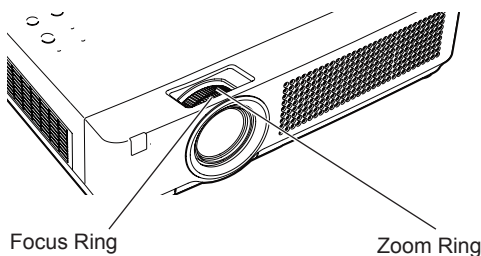

### Note

- It is recommended that the images are projected continuously for at least 30 minutes before the focus is adjusted.
- If you adjust the focus, you may need to adjust the size of the image by moving the zoom ring again.
- If keystone distortion occurs, see “KEYSTONE” (➔page 46).



# Basic operations by using the remote control

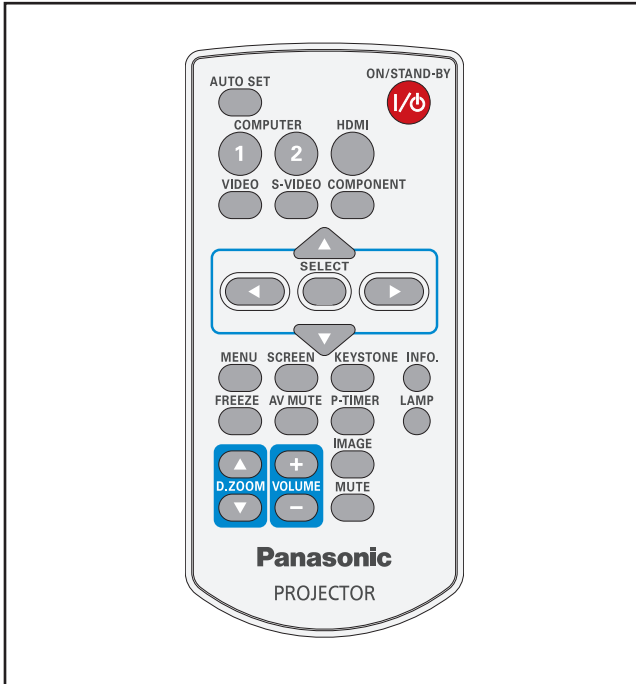

## Using the AUTO SET function

This function allows you to automatically adjust Input search, Auto Keystone correction and Auto PC adjustment during signal input from a computer.

**AUTO SET**  
 **button**



Press the <AUTO SET> button on the remote control.

### Note

- For details, see "Setting" of Main menu. (▶page 49)

## Switching the input signal

You can switch the input signals to project.

**COMPUTER 1** **COMPUTER 2** **HDMI**  
 **buttons**  
**VIDEO** **S-VIDEO** **COMPONENT**  

Press (<COMPUTER 1>, <COMPUTER 2>, <HDMI>, <VIDEO>, <S-VIDEO>, or <COMPONENT>) button on the remote control.

<b>COMPUTER 1</b>	Switches to Computer 1(RGB)/ Computer 1(Scart) input.
<b>COMPUTER 2</b>	Switches to Computer 2(RGB) input.
<b>HDMI</b>	Switches to HDMI input.
<b>VIDEO</b>	Switches to Video input.
<b>S-VIDEO</b>	Switches to S-video input.
<b>COMPONENT</b>	Switches to Computer 1 (Component) input.

### Note

- Each press of the <INPUT> button on the Control Panel of the main unit switches the settings as shown below. (▶page 17)

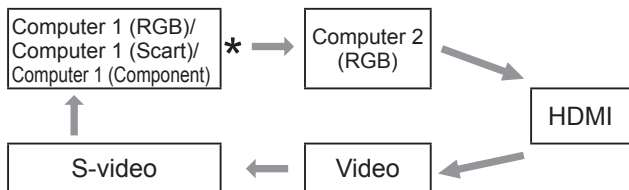

- \* It depends on the item you selected in the [Computer 1] submenu of the [Input] menu.

## Using the SCREEN button

This function allows you to select screen mode or change the screen size.

**SCREEN**  
 **button**

Press the <SCREEN> button on the remote control.

### Note

- For details, see "Screen" of Main menu. (▶page 45)

# Basic operations by using the remote control

## Using the KEYSTONE button

This function allows you to correct keystone distortion.

**KEYSTONE**  
 **button**

If a projected picture still has keystone distortion after pressing the <AUTO SET> button, correct the image manually as follows:

Press the <KEYSTONE> button on the remote control. The Keystone dialog box appears. Press ▲▼ to correct keystone distortion. The keystone adjustment can be stored (➔page 46).

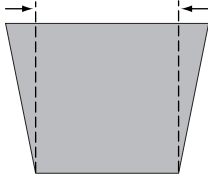
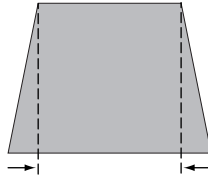
Operation	Screen image
Reduce the upper width with press ▲.	
Reduce the lower width with press ▼.	

### Note

- The white arrows indicate that there is no correction.
- A red arrow indicates the direction of correction.
- An arrow disappears at the maximum correction.
- If you press the <KEYSTONE> button on the remote control once more while the keystone dialog box is being displayed, the keystone adjustment will be canceled (➔page 46).
- The adjustable range is limited depending on the input signal.

## Using the INFO. button

This function allows you to display the information menu.

**INFO.**  
 **button**

**Press <INFO.> button on the remote control.**

### Note

- For details, see “Input Source Information Display” in “Information” under Main menu (➔page 56).

## Using the FREEZE function

You can freeze the projected image and stop the sound temporarily, regardless of the playing condition of the connected device.

**FREEZE**  
 **button**

Press the <FREEZE> button on the remote control to freeze the picture on the screen, meanwhile, volume is muted. To cancel the Freeze function, press the <FREEZE> button again or press any other button.

Fig.1 will appear on the screen while the [Freeze] function is working.

**Fig.1**



### Note

- When no signal inputs,  mark will appear.

# Basic operations by using the remote control

## Using the AV MUTE function

AV MUTE  
 button

Press the <AV MUTE> button on the remote control to black out the image. To restore to normal, press the <AV MUTE> button again or press any button.

- The screen changes each time you press the <AV MUTE> button as follows.



### Note

- When use the <MUTE> button to release the [AV mute] function, the mute function can not be operated at the same time.

## Using the P-TIMER button

Press the <P-TIMER> button on the remote control to operate the Count up/Count down function.

P-TIMER  
 button

Press <P-TIMER> button on the remote control.

### Note

- To stop the count time, press the <P-TIMER> button. To cancel the [P-timer] function, press and hold the <P-TIMER> button. (➔page 52)

## Using the LAMP button

This function allows you to select the lamp mode for changing the brightness on the screen.

LAMP  
 button

Press <LAMP> button on the remote control.

### Note

- For details, see "Lamp Power" of "Setting" under Main menu. (➔page 53)

## Using the D.ZOOM buttons

This function allows you to enter to the Digital zoom +/- mode.

 buttons

Press <D.ZOOM ▲/▼> buttons on the remote control.

### Note

- For details, see "Screen" of Main menu. (➔page 46)

## Controlling the volume of the speaker

You can control the volume of the projector's speaker or audio output.

 buttons

Press the <VOLUME+/-> buttons on the control panel or on the remote control to adjust the volume. The volume dialog box appears on the screen for a few seconds.

### Note

- For details, see "Volume" of "Sound" under Main menu. (➔page 48)

## Basic operations by using the remote control

### Using the IMAGE button

This function allows you to select a desired image mode of the screen.

IMAGE

 **button**

Press <IMAGE> button on the remote control to select the desired image mode among [Dynamic], [Standard], [Real], [Cinema], [Blackboard (Green)], [Colorboard], [Image 1], [Image 2], [Image 3] and [Image 4].

#### Note

- For details, see “Image select” of Main menu. (➔page 41)

### Using the MUTE button

Press this button on the remote control to temporarily turn off the sound.

MUTE

 **button**

**Press <MUTE> button on the remote control.**

#### Note

- To turn the sound back on, press this button again or press the <VOLUME+/-> buttons. (➔page 48)

# Menu Navigation

## Navigating through the menu

### Operating procedure

#### 1) Press the <MENU> button.

The Main Menu screen appears.

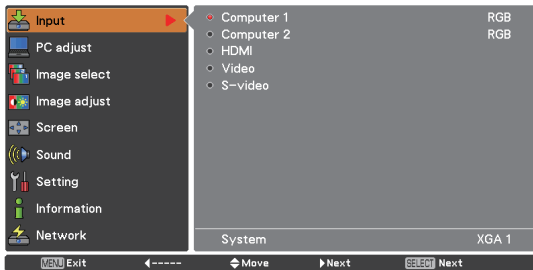

#### 2) Press ▲▼ to select the Main Menu item.

Select the desired item from the 9 items: [Input], [PC adjust], [Image select], [Image adjust], [Screen], [Sound], [Setting], [Information] and [Network]. The selected item is highlighted with an orange cursor and the submenu of the selected item appears on the right.

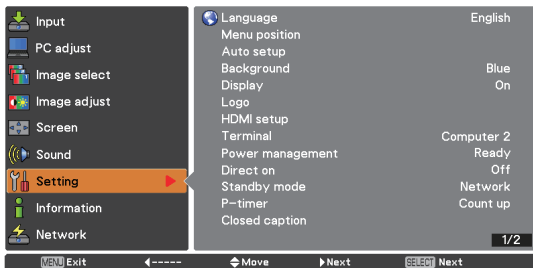

#### 3) Press ► or the <SELECT> button.

The submenu appears so that you can select the sub-menu item.

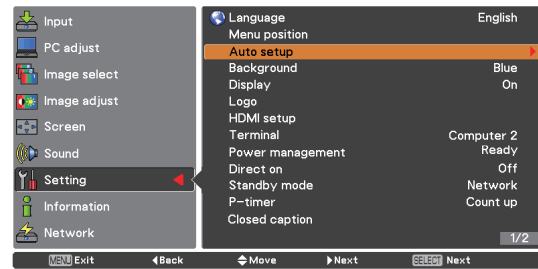

#### 4) Press ▲▼ to select the desired sub-menu item.

#### 5) Press the <SELECT> button or press ► to enter the desired item.

#### 6) Press ▲▼ ◀▶ to set or adjust the parameter values.

#### 7) Press ◀ to return the previous menu. Press the <MENU> button to exit the menu display.

#### Note









- Some items may not be adjusted or used for certain signal formats input to the projector. The MENU items that cannot be adjusted or used are shown in gray characters, and they cannot be selected.
- Some items can be adjusted even if signals are not input.
- See page 34 and 35 for details on the items of sub-menu.

# Menu Navigation

## Main menu

The main menu consists of the following 9 menu items.

When a main menu item is selected, the screen changes to a submenu selection screen.

	Input
	PC adjust
	Image select
	Image adjust
	Screen
	Sound
	Setting
	Information
	Network

## Sub menu

The sub-menu screen of the selected main menu appears, and you can set and adjust the various items in the submenu.

### Input [ ]

Sub-menu item	Factory default	Page
Computer 1	RGB	36
Computer 2	RGB	36
HDMI	-	36
Video	-	36
S-video	-	36

### PC adjust [ ]

Sub-menu item	Factory default	Page
AUTO PC adj.	-	38
Fine sync.	-	39
Total dots	-	39
Horizontal	-	39
Vertical	-	39
Current mode	-	40
Clamp	-	40
Display area H	-	40
Display area V	-	40
Reset	-	40
Mode free	-	40
Store	-	40

#### Note

- This function will be available when the input source come from computer.

### Image select [ ]

Sub-menu item	Factory default	Page
Dynamic	-	41
Standard	-	41
Real	-	41
Cinema*1	-	41
Blackboard(Green)	-	41
Colorboard	Red	41
Image 1-4	-	41

\*1 : When input video signal to the projector, this function will be available.

### Image adjust [ ]

Sub-menu item	Factory default	Page
Contrast	32	42
Brightness	32	42
Color*1	32	42
Tint*1	32	42
Color temp.	Mid	42
Red	32	43
Green	32	43
Blue	32	43
Sharpness	8	43
Gamma	8	43
Noise reduction*1	L1	43
Progressive*1	L1	44
Reset	-	44
Store	-	44

\*1 : When input video signal to the projector, these functions will be available.

## Screen [ ]

Sub-menu item	Factory default	Page
Normal	-	45
Full	-	45
Wide (16:9)	-	45
Zoom	-	45
True*1	-	45
Custom	-	45
Custom adj.	-	46
Digital zoom + *1	-	46
Digital zoom - *1	-	46
Keystone	Store	46
Ceiling	Off	47
Rear	Off	47
Reset	-	47

\*1 : When input computer signal to the projector, these functions will be available.

## Sound [ ]

Sub-menu item	Factory default	Page
Volume	32	48
Mute	Off	48
MIC	Off	48
MIC gain	32	48
Standby MIC out	Off	48

## Setting [ ]

Sub-menu item	Factory default	Page
Language	English	49
Menu position	Center	49
Auto setup	-	49
Background	Blue	50
Display	On	50
Logo	-	50
HDMI setup	-	51
Terminal	Computer 2	51
Power management	Shut down	51
Direct on	Off	52
Standby mode	Eco	52
P-timer	Count up	52
Closed caption	Off	53
Lamp power	Auto	53
Remote control	ALL	53
Security	-	53
Fan	L2	54
Fan control	Off	54

Sub-menu item	Factory default	Page
Video delay control	Off	55
Filter counter	-	55
Total power savings	-	55
Warning log	-	55
Factory default	-	55

## Information [ ]

Sub-menu item	Factory default	Page
Input	-	56
System	-	56
H-sync freq.	-	56
V-sync freq.	-	56
Screen	-	56
Language	-	56
Lamp power	-	56
Lamp runtime	-	56
Power management	-	56
Key lock	-	56
PIN code lock	-	56
Remote control	-	56
Serial number	-	56
Total power savings	-	56

## Network [ ]

Sub-menu item	Factory default	Page
Projector name	-	57
Network setup	-	57
Network control	On	58
Network status	-	58
AMX D.D.	Off	58
Network factory default	-	58

# Input menu

Select [Input] from the Main Menu (see “Navigating through the menu” on page 33), then select the item from the sub-menu.

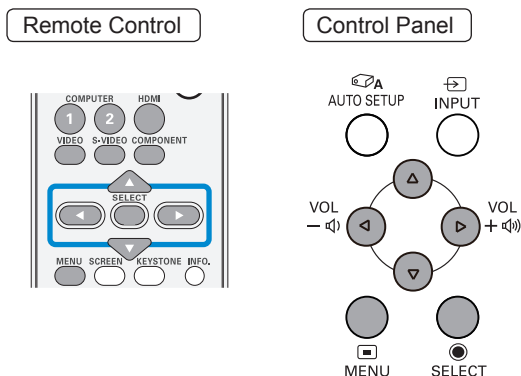

**Mode 1** The preset system is manually adjusted in the PC adjust Menu. The adjusted data can be stored in Mode 1-10.

**SVGA 1** PC Systems provided in this projector is chosen. The projector chooses a proper system provided in the projector and displays it.

\* Mode 1 and SVGA 1 are examples.

- 1) Press ▲ ▼ to select [System].
- 2) Press ► or the <SELECT> button to access the submenu.
- 3) Press ▲ ▼ to select the desired system.

## Computer 1: RGB/Component /RGB (Scart)

- 1) Press ▲ ▼ to select [Computer 1].
- 2) Press ► to access the submenu.
- 3) Press ▲ ▼ to select RGB, Component or RGB(Scart).

## HDMI

Press ▲ ▼ to select [HDMI] and then press the <SELECT> button.

## Video

Press ▲ ▼ to select [Video] and then press the <SELECT> button.

## S-video

Press ▲ ▼ to select [S-video] and then press the <SELECT> button.

## Video System Selection

**Video or S-video**  
**Auto**

The projector automatically detects an incoming video system, and adjusts itself to optimize its performance. When Video System is [PAL-M] or [PAL-N], select the system manually.

### PAL/SECAM/NTSC/NTSC4.43/PAL-M/PAL-N

If the projector cannot reproduce proper video image, select a specific broadcast signal format from among [PAL], [SECAM], [NTSC], [NTSC 4.43], [PAL-M] and [PAL-N].

## Computer 2: RGB

Press ▲ ▼ to select [Computer 2 (RGB)] and then press the <SELECT> button.

### Computer System Selection

This projector automatically tunes to various types of computers with its Multi-scan system and Auto PC Adjustment. If a computer is selected as a signal source, this projector automatically detects the signal format and tunes to project a proper image without any additional settings. (Signal formats provided in this projector are shown on pages 86-89.)

**Auto** When the projector can not recognize the connected signal conforming to the provided PC Systems, **Auto** is displayed on the System Menu box and the Auto PC adjustment function works to display proper images. If the image is not projected properly, a manual adjustment is required.

**....** There is no signal input from the computer. Check the connection between your computer and the projector.



## Component

### Auto

The projector automatically detects an incoming video signal, and adjusts itself to optimize its performance.

### COMPONENT VIDEO SIGNAL FORMAT

If the projector cannot reproduce proper video image, select a specific component video signal format among [480i], [576i], [480p], [576p], [720p], [1 035i] and [1 080i].

- 1) Press ▲ ▼ to select [System].
- 2) Press ► or the <SELECT> button to access the submenu.
- 3) Press ▲ ▼ to select the desired system.

#### Note

- When the [Input Search] function is set to [On 1] or [On 2] in the [Auto setup] function, the input signal will be searched automatically.
- The AV System Menu cannot be selected when selecting [RGB (Scart)].

# Auto PC adjust

Select [PC adjust] from the Main Menu (see “Navigating through the menu” on page 33), then select the item from the sub-menu.

Remote Control

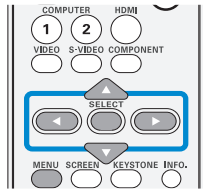

Control Panel

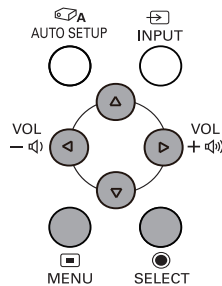

## Auto PC adj.

Auto PC adjustment function is provided to automatically adjust [Fine sync], [Total dots], [Horizontal] and [Vertical] positions to conform to your computer.

**Press ▲ ▼ to select [AUTO PC adj.] and then press the <SELECT> button.**

- [Please wait...] appears while the Auto PC adjustment is in process.

### To store adjustment parameters

The adjusted parameters from the Auto PC adjustment can be stored in the projector. Once the parameters are stored, the setting can be done just by selecting a Mode (1–10) in the PC System Menu (see page 36). See also [Store] on page 40.

#### Attention

- [Fine sync], [Total dots], [Horizontal] and [Vertical] position of some computers cannot be fully adjusted with the Auto PC adjustment function. When the image is not provided properly with this operation, manual adjustments are required (► pages 39-40).
- The Auto PC adjustment cannot be operated when [480i], [576i], [480p], [576p], [720p], [1 035i] or [1 080i] is selected in the PC System Menu (► page 36), or when the signal is coming from the HDMI terminal.

# Manual PC adjust

Select [PC adjust] from the Main Menu (see “Navigating through the menu” on page 33), then select the item from the sub-menu.

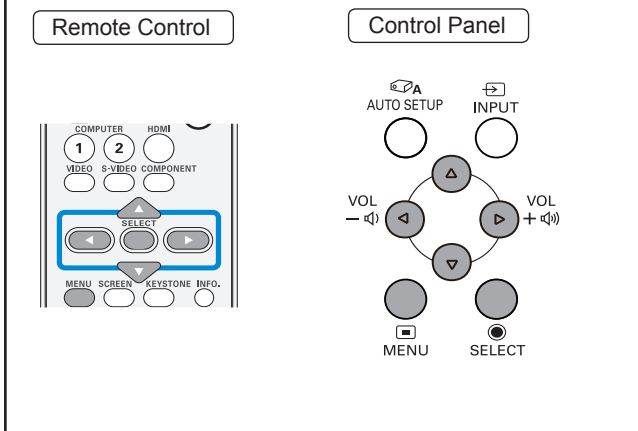

Some computers employ special signal formats which may not be tuned by Multi-scan system of this projector. Manual PC adjustment enables you to precisely adjust several parameters to match those signal formats. The projector has 10 independent memory areas to store those parameters manually adjusted. It allows you to recall the setting for a specific computer.

## Fine sync

- 1) Press ▲▼ to select [Fine sync].
- 2) Press the <SELECT> button to display the adjustment dialog box.
- 3) Press ◀▶ to adjust the value.
  - The value can be adjusted from 0 to 31.

## Total dots

- 1) Press ▲▼ to select [Total dots].
- 2) Press the <SELECT> button to display the adjustment dialog box.
- 3) Press ◀▶ to adjust the value.

## Horizontal

- 1) Press ▲▼ to select [Horizontal].
- 2) Press the <SELECT> button to display the adjustment dialog box.
- 3) Press ◀▶ to adjust the horizontal picture position.

### ■ For horizontal (right and left) adjustment

Operation	Adjustment
Press ◀.	The picture position moves to the right.
Press ▶.	The picture position moves to the left.

## Vertical

- 1) Press ▲▼ to select [Vertical].
- 2) Press the <SELECT> button to display the adjustment dialog box.
- 3) Press ◀▶ to adjust the vertical picture position.

### ■ For vertical (up and down) adjustment

Operation	Adjustment
Press ▶.	The picture position moves up.
Press ◀.	The picture position moves down.

## Manual PC adjust

### Current mode

- 1) Press ▲ ▼ to select [Current mode].
- 2) Press ► or the <SELECT> button to enter the next submenu to show H-sync freq. and V-sync freq. of the connected computer.

### Clamp

- 1) Press ▲ ▼ to select [Clamp].
- 2) Press the <SELECT> button to display the adjustment dialog box.
- 3) Press ◀ ▶ to adjust the clamp level.
  - When the image has dark bars, try this adjustment.

### Display area H

- 1) Press ▲ ▼ to select [Display area H].
- 2) Press the <SELECT> button to display the adjustment dialog box.
- 3) Press ◀ ▶ to adjust the horizontal area displayed by this projector.

### Display area V

- 1) Press ▲ ▼ to select [Display area V].
- 2) Press the <SELECT> button to display the dialog box.
- 3) Press ◀ ▶ to adjust the vertical area displayed by this projector.

### Reset

To reset the adjusted data, all adjustments will return to their previous figures.

- 1) Press ▲ ▼ to select [Reset].
- 2) Press the <SELECT> button.
  - A confirmation box appears and then select [Yes].

### Mode free

- 1) Press ▲ ▼ to select [Mode free].
- 2) Press ► or the <SELECT> button to enter the next submenu.
  - Move the highlight to the mode that you want to clear and then press the <SELECT> button.
  - A confirmation box appears and then select [Yes].

### Store

- 1) Press ▲ ▼ to select [Store].
- 2) Press ► or the <SELECT> button to enter the next submenu.
  - Move the highlight to one of the Modes 1 to 10 in which you want to store, and then press the <SELECT> button.
  - A confirmation box appears and then select [Yes].

# Image select

Select [Image select] from the Main Menu (see “Navigating through the menu” on page 33), then select the item from the sub-menu.

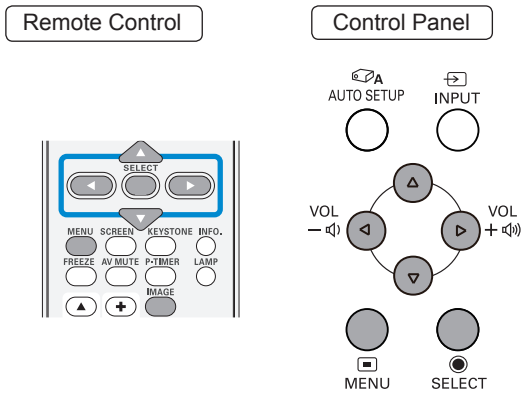

## Dynamic

For viewing pictures in a bright room.  
**Press ▲ ▼ to select [Dynamic] and then press the <SELECT> button.**

## Standard

Normal picture mode preset on the projector.  
**Press ▲ ▼ to select [Standard] and then press the <SELECT> button.**

## Real

Picture mode with improved halftone for graphics.  
**Press ▲ ▼ to select [Real] and then press the <SELECT> button.**

## Cinema

Picture mode adjusted with fine tone.  
**Press ▲ ▼ to select [Cinema] and then press the <SELECT> button.**

## Blackboard(Green)

For the image projected on a blackboard.  
**Press ▲ ▼ to select [Blackboard(Green)] and then press the <SELECT> button.**

- This mode helps enhance the image projected on a blackboard. This is mainly effective on a green colored board, not truly effective on a black colored board.

## Colorboard

For the image projected on a colorboard.

- 1) **Press ▲ ▼ to select [Colorboard].**
- 2) **Press ► or the <SELECT> button to display the submenu.**
  - At the time of simple projection on the colored wall, you can get the close color image to the color image projected on a white screen by selecting the similar color to the wall color from the preset four colors.

## Image 1-4

For viewing with the user preset image mode in the Image adjust Menu. This Image memory is provided in each computer, component and video input source.  
**Press ▲ ▼ to select [Image 1-4] and then press the <SELECT> button.**

# Image adjust

Select [Image adjust] from the Main Menu (see “Navigating through the menu” on page 33), then select the item from the sub-menu.

Remote Control

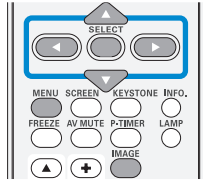

Control Panel

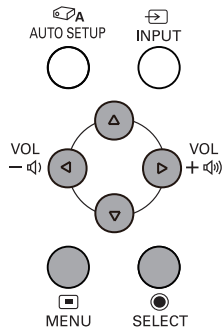

## Note

Make sure you selected [Store] after adjusting settings. Some settings can not be stored if not registered with [Store] function.

## Contrast

- 1) Press ▲ ▼ to select [Contrast].
- 2) Press the <SELECT> button to display the adjustment dialog box.
- 3) Press ◀ ▶ to adjust the setting value.

Operation	Adjustment	Adjustment range
Press ▶.	increase the contrast	Maximum value 63
Press ◀.	decrease the contrast	Minimum value 0

## Brightness

- 1) Press ▲ ▼ to select [Brightness].
- 2) Press the <SELECT> button to display the adjustment dialog box.
- 3) Press ◀ ▶ to adjust the setting value.

Operation	Adjustment	Adjustment range
Press ▶.	increase the brightness	Maximum value 63
Press ◀.	decrease the brightness	Minimum value 0

## Color

- 1) Press ▲ ▼ to select [Color].
- 2) Press the <SELECT> button to display the adjustment dialog box.
- 3) Press ◀ ▶ to adjust the setting value.

Operation	Adjustment	Adjustment range
Press ▶.	increase the intensity of the color	Maximum value 63
Press ◀.	decrease the intensity of the color	Minimum value 0

## Note

- When input video signal to the projector, [Color] will be available.

## Tint

- 1) Press ▲ ▼ to select [Tint].
- 2) Press the <SELECT> button to display the adjustment dialog box.
- 3) Press ◀ ▶ to adjust the tint value to get a proper color balance.
  - Adjustments can be made between 0 and 63.

## Note

- When you select [NTSC] or [NTSC4.43] in System menu under Video input signal, [Tint] will be available.

## Color temp.

- 1) Press ▲ ▼ to select [Color temp.].
- 2) Press the <SELECT> button to display the adjustment dialog box.
- 3) Press ◀ ▶ to select the desired Color temp. level.
  - You can select the desired [Color temp.] from [XLow], [Low], [Mid] or [High].

## Note

- [Color temp.] level displays [Blackboard] or [Colorboard] when the [Blackboard(Green)] or [Colorboard] is selected in the [Image select] menu.

## Red

- 1) Press ▲▼ to select [Red].
- 2) Press the <SELECT> button to display the adjustment dialog box.
- 3) Press ◀▶ to adjust the setting value.

Operation	Adjustment	Adjustment range
Press ▶.	deepen red tone	Maximum value 63
Press ◀.	lighten red tone	Minimum value 0

## Green

- 1) Press ▲▼ to select [Green].
- 2) Press the <SELECT> button to display the adjustment dialog box.
- 3) Press ◀▶ to adjust the setting value.

Operation	Adjustment	Adjustment range
Press ▶.	deepen green tone	Maximum value 63
Press ◀.	lighten green tone	Minimum value 0

## Blue

- 1) Press ▲▼ to select [Blue].
- 2) Press the <SELECT> button to display the adjustment dialog box.
- 3) Press ◀▶ to adjust the setting value.

Operation	Adjustment	Adjustment range
Press ▶.	deepen blue tone	Maximum value 63
Press ◀.	lighten blue tone	Minimum value 0

## Sharpness

- 1) Press ▲▼ to select [Sharpness].
- 2) Press the <SELECT> button to display the adjustment dialog box.
- 3) Press ◀▶ to adjust the setting value.

Operation	Adjustment	Adjustment range
Press ▶.	increase the sharpness of the image	Maximum value 15
Press ◀.	decrease the sharpness of the image	Minimum value 0

## Gamma

- 1) Press ▲▼ to select [Gamma].
- 2) Press the <SELECT> button to display the adjustment dialog box.
- 3) Press ◀▶ to adjust the gamma value to obtain a better balance of contrast.
  - Adjustments can be made between 0 and 15.

## Noise reduction

- 1) Press ▲▼ to select [Noise reduction].
- 2) Press the <SELECT> button to display the adjustment dialog box.
- 3) Press ◀▶ to select the desired item

Off	Disabled
L1	Lower reduction
L2	Higher reduction

- Noise interference on the screen can be reduced. Select one of the above options to get smoother images.
- [Noise reduction] cannot be selected when [480p], [576p], [720p], [1 035i] or [1 080i] is selected.

## Note

- When input video signal to the projector, [Noise reduction] will become available.

# Image adjust

## Progressive

- 1) Press ▲ ▼ to select [Progressive].
- 2) Press the <SELECT> button to display the dialog box.
- 3) Press ◀ ▶ to select the desired item.
  - An interlaced video signal can be displayed in progressive mode. Select one of the following options.
  - [Progressive] cannot be selected when [480p], [576p], [720p], [1 035i] or [1 080i] is selected.

Off	Disabled
L 1	For an active picture
L 2	For a still picture
Film	For watching a film

### Note

- When input video signal to the projector, [Progressive] will become available.

## Reset

To reset the adjusted data, all adjustments will return to their previous figures.

- 1) Press ▲ ▼ to select [Reset].
- 2) Press the <SELECT> button.
  - A confirmation box appears and then select [Yes].

## Store

- 1) Press ▲ ▼ to select [Store].
- 2) Press ▶ or the <SELECT> button.
- 3) Press ▲ ▼ to select one from Image 1 to 4 and press the <SELECT> button.
  - A confirmation box appears and then select [Yes].



# Screen

Select [Screen] from the Main Menu (see “Navigating through the menu” on page 33), then select the item from the sub-menu.

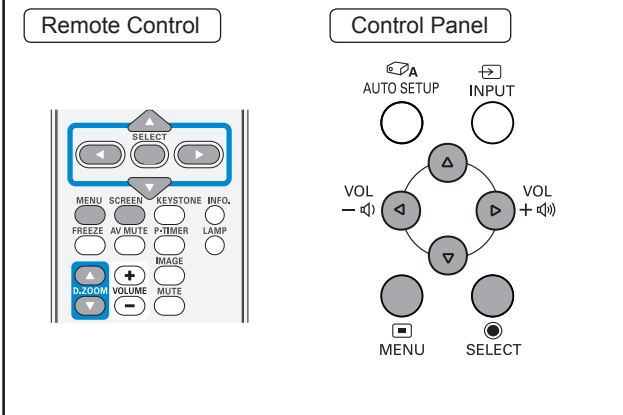

## Normal

Provide the image to fit the screen size while maintaining the aspect ratio of the input signal.

**Press ▲▼ to select [Normal] and then press the <SELECT> button.**

## Full

Provide the full screen image.

**Press ▲▼ to select [Full] and then press the <SELECT> button.**

## Wide(16:9)

Provide the image at the 16:9 wide screen ratio.

**Press ▲▼ to select [Wide(16:9)] and then press the <SELECT> button.**

## Zoom

Scale the image proportionally to fit the entire screen. Either side of image may go over the screen.

**Press ▲▼ to select [Zoom] and then press the <SELECT> button.**

## True

Provide the image in its original size. When the original image size is larger than the panel size (1 024 x 768), the projector enters to the panning mode automatically.

**1) Press ▲▼ to select [True] and then press the <SELECT> button.**

**2) Press ▲▼◀▶ to pan the image.**

- When adjusted, the arrows will turn red. When reached to the correction limits, the arrows will disappear.

### Note

- When input computer signal to the projector, [True] will be available.
- [True] is disabled and cannot be displayed when [480i], [576i], [480p], [576p], [720p], [1 035i] or [1 080i] is selected in the PC System Menu.
- When [True] is selected in the Screen menu, [Digital zoom +/-] can not be selected.

## Custom

Provide the last stored aspect screen image.

**Press ▲▼ to select [Custom] and press the <SELECT> button.**

# Screen

## Custom adj.

Adjust the screen scale and position manually with this function.

- 1) Press ▲ ▼ to select [Custom adj.].
- 2) Press ► or the <SELECT> button to enter the next submenu.
- 3) Press ▲ ▼ to choose the item you want to adjust.
  - You can choose one from the items as below:

Scale H/V	Adjust the Horizontal/Vertical screen scale.
H&V	When set to [On], the aspect ratio is fixed.
Position H/V	Adjust the Horizontal/Vertical screen position.
Common	Save the adjusted scale or position to all the inputs.
Reset	Reset the all adjusted values.

## Digital zoom +

Zoom in the images.

- 1) Press ▲ ▼ to select [Digital zoom +] and then press the <SELECT> button.
  - The On-Screen Menu disappears and [D. zoom + ] appears.
- 2) Press the <SELECT> button to zoom in the image size and press ▲ ▼ ◀▶ to move the image to the top/bottom/left/right of the screen.
  - The Panning function can work only when the image is larger than the screen size. A projected image can be also expanded by pressing the <D.ZOOM ▲> or the <SELECT> button.

## Digital zoom -

Zoom out the images.

- 1) Press ▲ ▼ to select [Digital zoom -] and then press the <SELECT> button.
  - The On-Screen Menu disappears and [D.zoom - ] appears.
- 2) Press the <SELECT> button to zoom out image size.
  - The projected image can be also compressed by pressing the <D.ZOOM ▼> or the <SELECT> button.

To exit the Digital zoom +/- mode, press any button except the <D.ZOOM ▲/▼>, <SELECT> and ▲ ▼ ◀▶ buttons.

To return to the previous screen size, select a screen size from the Screen Size Adjustment Menu or select an input source from the Input Source Selection Menu (►page 36) again, or adjust the screen size with the <D.ZOOM ▲/▼> buttons.

### Note

- When input computer signal to the projector, this function will be available.
- [Digital zoom +/-] cannot be selected when [True] is selected in the Screen aspect.
- [Digital zoom +/-] are disabled and cannot be displayed when [480i], [576i], [480p], [576p], [720p], [1 035i] or [1 080i] is selected in the PC System Menu (►page 36).
- When [Digital zoom +/-] functions are disabled, ! mark will appear.

## Keystone

This function is used to adjust keystone distortion of the projected image.

- 1) Press ▲ ▼ to select [Keystone].
- 2) Press ► or the <SELECT> button.
- 3) Press ▲ ▼ to choose the item you want to adjust.

Keystone	To correct keystone distortion
Store	To store or reset the keystone correction



The following items are the submenus of [Store].

Store	Keep the keystone correction even when the AC power cord is plugged out or turned off the projector.
Reset	Release the keystone correction when the AC power cord is plugged out.

## Ceiling

This function is used to project the image from a ceiling-mounted projector.

- 1) Press ▲▼ to select [Ceiling] and then press the <SELECT> button.
- 2) Press ▲▼ to change the image.
  - When this function is set to [On], the picture will be top/bottom and left/right reversed.

## Rear

This function is used to project the image from rear of the screen.

- 1) Press ▲▼ to select [Rear] and then press the <SELECT> button.
- 2) Press ▲▼ to change the image.
  - When this function is set to [On], the picture will be left/right reversed.

## Reset

To reset the adjusted data, all adjustments will return to their previous figures.

**Press ▲▼ to select [Reset] and then press the <SELECT> button.**

- A confirmation box appears and then select [Yes].

# Sound

Select [Sound] from the Main Menu (see “Navigating through the menu” on page 33), then select the item from the sub-menu.

Remote Control

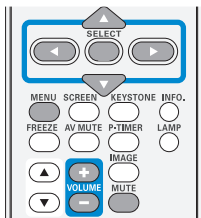

Control Panel

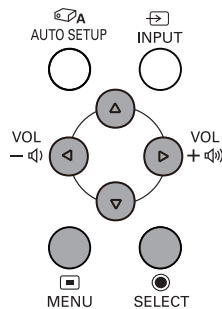

## Volume

- 1) Press ▲▼ to select [Volume] and then Press the <SELECT> button.
- 2) Press ◀▶ to adjust the volume.
  - Press <SELECT> button to set the volume.

Operation	Adjustment	Adjustment range
Press ▶.	turn up the volume	Maximum value 63
Press ◀.	turn down the volume	Minimum value 0

- You can also press <VOLUME+/-> buttons on the remote control or control panel to adjust the volume.

## Mute

- 1) Press ▲▼ to select [Mute] and then Press the <SELECT> button.
- 2) Press the <SELECT> button to switch the mute function [On]/[Off].
  - Press the <MUTE> button on the remote control to temporarily turn off the sound. To turn the sound back on, press the <MUTE> button again or press the <VOLUME+/-> buttons.

## MIC

- 1) Press ▲▼ to select [MIC] and then Press the <SELECT> button.
- 2) Press ▲▼ to switch the [MIC] function [On]/[Off].
  - When [Off] is selected in [MIC] function, the [MIC gain] and [Standby MIC out] functions are not available.
  - Connect the computer 2 audio input signals to COMPUTER AUDIO IN 1 terminal as Sound function is set to Computer 2 and MIC function is turned on.
  - If the [MIC] function is turned on when connecting PC audio to the AUDIO IN (a mini jack), loud sound may be output suddenly depending on the setting value of [MIC gain].

## MIC gain

- 1) Press ▲▼ to select [MIC gain] and then Press the <SELECT> button.
- 2) Press ◀▶ to adjust the MIC mixing gain.
  - Press <SELECT> button to set the [MIC gain].

Operation	Adjustment	Adjustment range
Press ▶.	turn up the MIC mixing gain	Maximum value 63
Press ◀.	turn down the MIC mixing gain	Minimum value 0

## Standby MIC out

- 1) Press ▲▼ to select [Standby MIC out] and then Press the <SELECT> button.
- 2) Press ▲▼ to switch the [Standby MIC out] function [On]/[Off].
  - When setting the [Standby MIC out] function to [On] and in Standby mode status, only [MIC] input volume can be output. Press the <VOLUME+/-> buttons on the control panel or on the remote control to adjust the MIC input volume.
  - Only the Standby mode is set to [Network], [Standby MIC out] can be selected.

# Setting

Select [Setting] from the Main Menu (see “Navigating through the menu” on page 33), then select the item from the sub-menu.

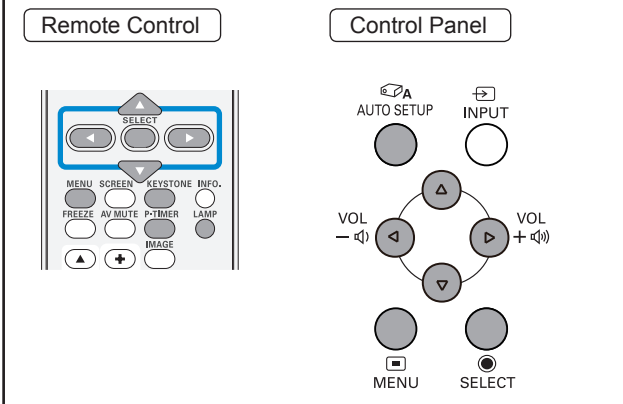

## Language

- 1) Press ▲ ▼ to select [Language].
- 2) Press ► or the <SELECT> button.
- 3) Press ▲ ▼ to select the desired language.

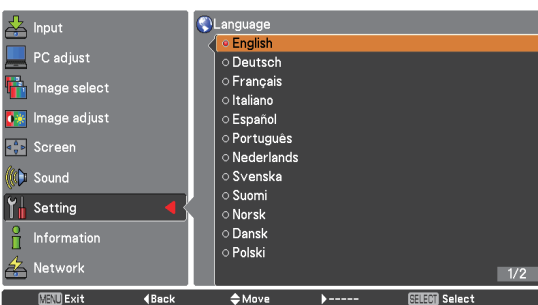
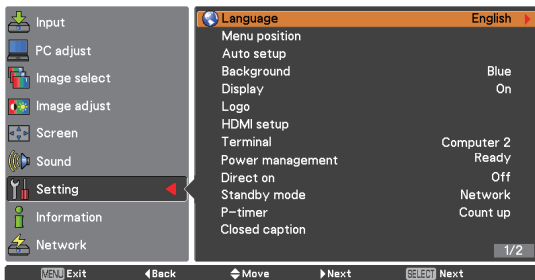

- The language used in the On-Screen Menu is available in English, German, French, Italian, Spanish, Portuguese, Dutch, Swedish, Finnish, Norwegian, Danish, Polish, Hungarian, Romanian, Czech, Russian, Turkish, Arabic, Kazak, Vietnamese, Chinese, Korean, Japanese and Thai.

## Menu position

This function is used to change the position of the On-Screen Menu.

- 1) Press ▲ ▼ to select [Menu position].
- 2) Press the <SELECT> button to change the position.
  - The Menu position changes each time you press <SELECT> button as follows:

the center → the bottom left → the bottom right → the top left → the top right → the center.....

## Auto setup

- 1) Press ▲ ▼ to select [Auto setup].
- 2) Press ► or the <SELECT> button.
- 3) Press ▲ ▼ to select these functions as follows:

### Input search

This function detects the input signal automatically. When a signal is found, the search will stop.

Off	Input search will not work
On 1	Input search works* <sup>1</sup>
On 2	Input search works* <sup>2</sup>

\*1 : • When pressing the <AUTO SET> button on the remote control or the <AUTO SETUP> button on the control panel.

\*2 : • When turning on the projector by pressing the <ON/STAND-BY> button on the remote control or control panel.

- When pressing the <AUTO SET> button on the remote control or the <AUTO SETUP> button on the control panel.

- When the current input signal is cut off.\*

\* If the AV mute or Freeze function is active, cancel it to activate the Input search. It is also unavailable when On-Screen menu is displayed.

### Auto PC adj.

On	Enables Auto PC adjustment * <sup>1</sup>
Off	Disables Auto PC adjustment

\*1 : When pressing the <AUTO SET> button on the remote control or the <AUTO SETUP> button on the control panel.

# Setting

## Auto keystone

<b>Auto</b>	Always works and corrects keystone distortion according to the projector's tilt.
<b>Manual</b>	Works only when pressing the <AUTO SET> button on the remote control or the <AUTO SETUP> button on the control panel.
<b>Off</b>	Disables Auto Keystone.

### Note

- [Input search], [Auto PC adj.] and [Auto Keystone] cannot be set [Off] at the same time.
- The [Auto Keystone] function cannot work when the [Ceiling] feature is set [On] in the Setting menu.

## Background

Select the background screen for when no input signal is detected.

- 1) Press ▲ ▼ to select [Background].
- 2) Press the <SELECT> button.
- 3) Press ▲ ▼ to switch between each option as below.

<b>Blue</b>	Blue colored background.
<b>User</b>	The logo transferred by "Logo Transfer Software *1 " is projected.
<b>Black</b>	Black colored background.

\*1 : "Logo Transfer Software" is included on the supplied CD-ROM.

## Display

This function decides whether to display On-Screen Displays.

- 1) Press ▲ ▼ to select [Display].
- 2) Press the <SELECT> button.
- 3) Press ▲ ▼ to switch between each option as below.

<b>On</b>	Show all the On-Screen displays *1
<b>Countdown off</b>	Show the input image instead of the countdown when turning on the projector *2
<b>Off</b>	Hide the On-Screen Displays *3

- \*1 : Use this function when you want to project images after the lamp becomes bright enough. The factory default setting is in this option.
- \*2 : Use this function when you want to project the image as early as possible even when the lamp is not bright enough.
- \*3 : Hide the On-Screen Displays except;
  - On-Screen Menu.
  - [Power off?]
  - [P-timer] display.
  - No signal for [Power management]
  - [Please wait ...]
  - Arrows for the [True] function in the Screen Menu.

## Logo

This function allows you to customize the screen logo with [Logo select], [Logo PIN code lock] and [Logo PIN code change] functions.

- 1) Press ▲ ▼ to select [Logo].
- 2) Press ► or the <SELECT> button.
- 3) Press ▲ ▼ to choose the desired item.

## Logo select

This function decides on the starting-up display from among following options.

<b>Off</b>	Show the countdown display only.
<b>Default</b>	Show the factory-set logo.
<b>User</b>	The logo transferred by "Logo Transfer Software *1 " is projected.

\*1 : "Logo Transfer Software" is included on the supplied CD-ROM.

## Logo PIN code lock

This function prevents an unauthorized person from changing the screen logo.

<b>Off</b>	The screen logo can be changed freely from the Logo Menu.
<b>On</b>	The screen logo cannot be changed without a Logo PIN code.

### Note

- If you want to change the Logo PIN code lock setting, press the <SELECT> button and the Logo PIN code dialog box appears. Enter a Logo PIN code by following the steps below. The initial Logo PIN code is set to "4321" at the factory.

## Logo PIN code change

Logo PIN code can be changed to your desired four-digit number.

- 1) Press ▲▼ to select [Logo PIN code change] and press the <SELECT> button.
  - Current logo PIN code dialog box appears.
- 2) Press ▲▼ to enter the current code, press the ► button to fix the number and move the red frame pointer to the next box.
  - The New Logo PIN code input dialog box appears.
- 3) Repeat this step to set the new Logo PIN code.

### Attention

- Be sure to note the new Logo PIN code and keep it on hand. If you lost the number, you could no longer change the Logo PIN code setting.

## HDMI setup

This function is only used for HDMI input source.

- 1) Press ▲▼ to select [HDMI setup].
- 2) Press ► or the <SELECT> button.
  - The names for the output setting of Digital R/G/B vary from equipment to equipment.

## Image

Normal	When the output of Digital R/G/B equipment is set to Standard.
Enhanced	When the output of Digital R/G/B equipment is set to Enhanced.

## Sound

HDMI	When Digital input source is input, Sound is set to HDMI.
Computer 2	When DVI input source is changed to HDMI input source, Sound is set to Computer 2.

### Note

- For details, refer to the operating instructions of your Digital R/G/B equipment.
- Connect the computer 2 audio input signals to COMPUTER AUDIO IN 1 terminal as Sound function is set to Computer 2 and MIC function is turned on.

## Terminal

The COMPUTER IN 2/MONITOR OUT terminal on the back of the projector is switchable for computer 2 input or monitor output.

- 1) Press ▲▼ to select [Terminal] and then press the <SELECT> button.
- 2) Press ▲▼ to switch the item.

Computer 2	Computer input
Monitor out	Monitor out

### Note

- Terminal function is not available when selecting [Computer 2] to the input source. Change the input source to the others (HDMI or Computer 1 or Video) so that the Terminal function will be available.

## Power management

For reducing power consumption as well as maintaining the lamp life, the Power management function turns off the projection lamp when the projector is not operated for a certain period.

- 1) Press ▲▼ to select [Power management].
- 2) Press ► or the <SELECT> button to access the submenu.

## Mode

- 1) Press ▲▼ and then press the <SELECT> button to select one mode among the items as below.

Ready	When the lamp has been fully cooled down, the <POWER> indicator changes to green blinking. In this condition, the projection lamp will be turned on if the input signal is reconnected or any button on the control panel or remote control is pressed.
Shut down	When the lamp has been fully cooled down, the power will be turned off.
Off	[Power management] function is off.

## Timer

- 1) Press ▲▼ to select [Timer] and then press the <SELECT> button.
- 2) Press ▲▼ to set the Timer(1~30min).



# Setting

## Direct on

- 1) Press ▲ ▼ to select [Direct on] and then press the <SELECT> button.
- 2) Press ▲ ▼ to switch between [On] and [Off].
  - When this function is set to [On], the projector will be automatically turned on just by connecting the AC power cord to a wall outlet.
  - Be sure to turn off the projector properly. If the projector is turned off in the incorrect sequence, the [Direct On] function does not work properly.

## Standby mode

This function can set the electric power when the projector is standing by.

- 1) Press ▲ ▼ to select [Standby mode] and then press the <SELECT> button.
- 2) Press ▲ ▼ to switch between the items as below.

<b>Eco</b>	Restricts some functions in standby mode to reduce power consumption.
<b>Network</b>	Does not restrict functionality even in standby mode.

### Note

- When selecting [Network], the cooling fans may be running depending on the temperature inside the projector even if the projector is turned off.
- If Standby mode is set to [Eco], you cannot use network functions when the projector is standing by. Also, you cannot use some RS-232C protocol commands.
- If set to [Network], you can use network functions when the projector is standing by.

## P-timer

This function allows you to change the setting of the P-timer and execute it.

- 1) Press ▲ ▼ to select [P-timer].
- 2) Press ► or <SELECT> button to access the submenu.

## Mode

- 1) Press ▲ ▼ button to select one mode among the items as below.

<b>Count up</b>	The P-timer display 000:00 appears on the screen and the count up starts (000:00-180:00).
<b>Count down</b>	The time set in the Timer setting appears on the screen and the countdown starts.

## Timer

- 1) Press ▲ ▼ to select [Timer] and then press the <SELECT> button.
- 2) Press ▲ ▼ to set the [Timer](1-180 Min).
  - Timer is available in [Count down] only. Factory default value is 10 Min.

## Execute

- 1) Press ▲ ▼ to select one among the items as below and then press the <SELECT> button.

<b>Start</b>	It executes the count up or count down function.*1
<b>Reset</b>	Reset the P-timer values.*2
<b>Exit</b>	To exit the P-timer operation.

\*1 : Press the <SELECT> button at Start and the indication changes into Stop. To stop Count up or Count down, press the <SELECT> button at Stop on the screen menu, then the indication changes into Restart. Press the <SELECT> button at Restart to resume Count up or Count down.

\*2 : Press the <SELECT> button at Reset to return to the following value:

<b>Count up</b>	"000:00"
<b>Count down</b>	Timer that you set

### Note

- To stop the [P-timer] function, press the <P-TIMER> button.
- To cancel the [P-timer], press and hold the <P-TIMER> button for a few seconds.



## Closed caption

[Only for NTSC, 480i input]

- 1) Press ▲▼ to select [Closed caption].
- 2) Press ► or the <SELECT> button to enter the submenu.

### ■ Closed caption

- 1) Press ▲▼ to select [Closed caption] and then press the <SELECT> button.
- 2) Press ▲▼ to select [Off], [CC1], [CC2], [CC3] or [CC4].

### ■ Color

- 1) Press ▲▼ to select [Color] and then press the <SELECT> button.
- 2) Press ▲▼ to select [Color] or [White].





#### Note

- The closed caption is mainly used in the north America. This function shows the text information contained in the image signal. Captions may not be displayed on some devices or software.
- You can select [Closed caption] when [NTSC] or [480i] signals are input.
- Part of characters may not displayed when high compensation valued are set in [Keystone].
- Closed captions are not displayed while the menu screen appears.

## Lamp power

This function allows you to change brightness of the screen.

- 1) Press ▲▼ to select [Lamp power] and then press the <SELECT> button .
- 2) Press ▲▼ to select one among the modes as below.
  - You can also press the <LAMP> button to display [Lamp power].

 <b>Auto</b>	Brightness according to the input signal.
 <b>Normal</b>	The lamp power output is maximum.
 <b>Eco1</b>	The lamp power output is 70% of the Normal mode.
 <b>Eco2</b>	The lamp power output is 53% of the Normal mode.

## Remote control

This switching function prevents remote control interference when operating several projectors or video equipment at the same time.

- 1) Press ▲▼ to select [Remote control].
- 2) Press ► or the <SELECT> button.
- 3) Press ▲▼ to select one among the seven codes.

- This projector provides 7 different remote control codes: [ALL], [Code 1]~[Code 6].

#### Note

- When operating the projector under [ALL] code, you can operate several projectors at the same time. If you want to operate the projector independently, you must switch to other code.
- When different codes are set on the projector and on the remote control, any operation cannot be made. In that case, switch the code on the remote control to fit the code on the projector.
- If the batteries are removed from the remote control for a long period of time, the remote control code will be reset.

## Security



This function allows you to use the Key lock and PIN code lock function to set the security for the projector operation.

- 1) Press ▲▼ to select [Security].
- 2) Press ► or the <SELECT> button to access the submenu.

### ■ Key lock

This function locks the control panel and remote control buttons to prevent operation by unauthorized persons.

- 1) Press ▲▼ to select the desired items as below.

	Unlocked.
	Lock the operation of the control panel. To unlock, use the remote control.
	Lock the operation of the remote control. To unlock, use the control panel.

## PIN code lock

This function prevents the projector from being operated by unauthorized persons and provides the following setting options for security.

- 1) Press ▲ ▼ to select the desired items as below.

Off	Unlocked.
On 1	Enter the PIN code every time turning on the projector.
On 2	Enter the PIN code to operate the projector once the power cord is disconnected; as long as the AC power cord is connected, the projector can be operated without a PIN code.

### Note

- Whenever you change the PIN code lock setting or the PIN code (the four-digit number), you are required to enter the PIN code. The "1234" is set as the initial PIN code at the factory.

## PIN code change

The PIN code can be changed to your desired four-digit number.

- 1) Press ▲ ▼ to select [PIN code change] and then Press <SELECT> button.
  - Current PIN code dialog box appears.
- 2) Press ▲ ▼ to enter the current code. Press ► button to fix the number and move the red frame pointer to the next box.
  - The New PIN code input dialog box appears.
- 3) Repeat these steps to set a new PIN code.

### Attention

- Be sure to note the new Logo PIN code and keep it on hand. If you lost the number, you could no longer change the Logo PIN code setting.

## Fan

- 1) Press ▲ ▼ to select [Fan] and then Press <SELECT> button.
- 2) Press ▲ ▼ to select one option .
  - This function provides the following options in the cooling fans' operation when the projector is turned off.

L 1	It takes less time to cool the projector down than L2 mode.
L 2	Slower and lower-sound than L1 mode, but it takes more time to cool the projector down.

## Fan control

- 1) Press ▲ ▼ to select [Fan control] and then Press <SELECT> button.
- 2) Press ▲ ▼ to select one among options as below.
  - Choose the running speed of cooling fans from the following options according to the ground elevation under which you use the projector.

Off	Normal speed.*1
On 1	Faster than Off mode.*2
On 2	Faster than On 1 mode.*3

- \*1 : Set this function to [Off] when using the projector in non-high altitude environment.
- \*2 : When using the projector in the elevation of above 1 200 m and below 2 000 m, make sure [Fan control] is set to [On 1].
- \*3 : When using the projector in the elevation of above 2 000 m and below 2 700 m, make sure [Fan control] is set to [On 2].

### Note

- Failure to set the running speed of cooling fans properly may affect the projector life.
- The fan noise becomes louder in [On 1] and [On 2].

## Video delay control

This function allows you to make a digital processing of a projected image faster.

- 1) Press ▲▼ to select [Video delay control] and then Press the <SELECT> button.
- 2) Press ▲▼ to select one item between [On] and [Off].

### Note

- [Noise reduction] and [Progressive] can not be selected when [Video delay control] function is set to [On].

## Filter counter

This function is used to set a frequency for the filter replacement.

- 1) Press ▲▼ to select [Filter counter].
- 2) Press ► or the <SELECT> button to access the submenu items.

### ■ Filter counter

Show the total accumulated time of the filter use timer setting.

### ■ Timer

To set a timer. When the projector reaches the selected time the filter warning icon appears on the screen.

- 1) Press ▲▼ to select [Timer] and then press the <SELECT> button.
- 2) Press ▲▼ to set the Timer.
  - Select from [Off/1000 H/2000 H/3000 H/4000 H/5000 H/6000 H] depending on the use environment.

### ■ Filter counter reset

After replacing the filter, be sure to reset the timer.

- 1) Press ▲▼ to select [Filter counter reset].
- 2) Press the <SELECT> button.
  - [Filter counter Reset?] appears. Select [Yes] to continue. Another confirmation dialog box appears, select [Yes] to reset the [Filter counter].

## Total power savings

This function displays the saved amount of power and the exhausted CO2 of the projector.

- 1) Press ▲▼ to select [Total power savings] and then press the <SELECT> button.
  - Show the total accumulated power savings of the projector and display the total amount of CO2 exhausted from the projector.
- 2) Press the <SELECT> button to reset the figures of the total power savings and the exhausted CO2.
  - [Total power savings Reset?] appears. Select [Yes] to continue. Another confirmation dialog box appears, select [Yes] to reset the [Total power savings].

## Warning log

This function records anomalous operations while the projector is in operation and use it when diagnosing faults.

- 1) Press ▲▼ to select [Warning log].
- 2) Press ► or the <SELECT> button to display the latest warning message.
  - Up to 10 warning logs are displayed with the latest warning message at the top of the list, followed by previous warning messages in chronological order.

### Note

- When the [Factory default] function is executed, all the warning log records will be deleted.

## Factory default

This function returns all setting values except for [PIN code lock], [Logo PIN code lock], [Lamp power], [Filter counter] and [Total power savings] to the factory default settings.

- 1) Press ▲▼ to select [Factory default].
- 2) Press the <SELECT> button.
  - [Return to Factory default?] appears. Select [Yes] to continue. Another confirmation dialog box appears, select [Yes] to return to [Factory default].

# Information

Select [Information] from the Main Menu (see “Navigating through the menu” on page 33), then select the item from the sub-menu.

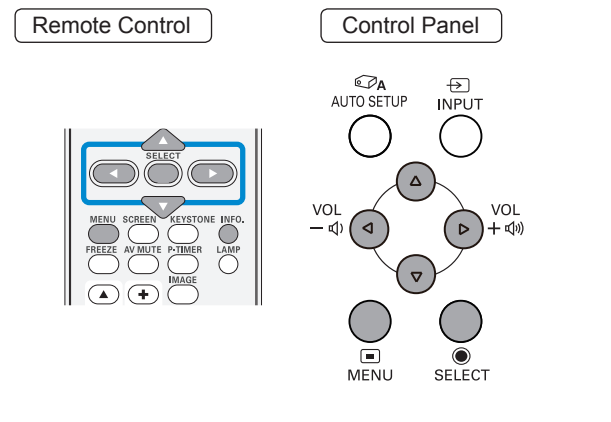

## Input Source Information Display

The Information Menu is used for checking the status of the image signal being projected and the operation of the projector.

You can also Press the <INFO.> button on the remote control to display the Information menu.

### ■ Input

The selected input source is displayed.

### ■ System

The selected system is displayed.

### ■ H-sync freq.

The selected H-sync freq. is displayed.  
The horizontal frequency of the input signal is displayed in kHz, or - - - - kHz when no signal.

### ■ V-sync freq.

The selected V-sync freq. is displayed.  
The vertical frequency of the input signal is displayed in Hz, or - - - - Hz when no signal. Numbers of Hz doubles when during Interlace.

### ■ Screen

The selected Screen size is displayed.

### ■ Language

The selected language is displayed.

### ■ Lamp power

The selected lamp mode is displayed.

### ■ Lamp runtime

The cumulative lamp operating time is displayed.

### ■ Power management

[Off] , [Ready] or [Shut down], and [Timer] are displayed.

### ■ Key lock

The selected Key lock icon is displayed.

### ■ PIN code lock

[Off], [On 1] or [On 2] is displayed.

### ■ Remote control

The selected remote control code is displayed.

### ■ Serial number

The serial number of the projector is displayed.  
The serial number is used to service the projector.

### ■ Total power savings

The saved amount of power and the exhausted CO2 are displayed.

# Network

Select [Setting] from the Main Menu (see “Navigating through the menu” on page 33), then select the item from the sub-menu.

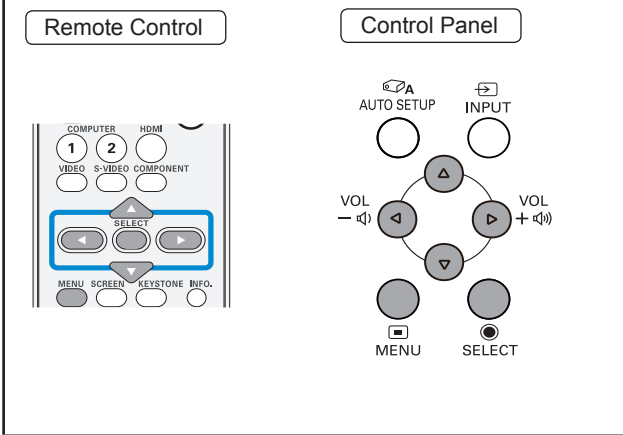

## Projector name

You can change the projector name to be displayed on the network.

- 1) Press **▲▼** to select [Projector name], and press **<SELECT>** button.
- 2) Select characters with the **▲▼◀▶** buttons and press the **<SELECT>** button to enter the projector name.
- 3) Select [Set] with the **▲▼◀▶** buttons and press the **<SELECT>** button.  
Select [Cancel] to undo the changes and then press the **<SELECT>** button. Select [BS] to delete one character selected with the cursor in the input box.
- 4) Select [Yes] or [No] with the **▲▼◀▶** buttons and press the **<SELECT>** button.

## Network setup

You can make detailed wired LAN settings.

- 1) Press **▲▼** to select [Network setup], and press **<SELECT>** button.
- 2) Press **▲▼** to select an item, and change the setting according to the instructions.

<b>DHCP (DHCP client function)</b>	On:	If a DHCP server exists in the network to which the projector is connected, the IP address will automatically be acquired.
	Off:	If a DHCP server does not exist in the network to which the projector is connected, additionally set [IP address], [Subnet mask] and [Default gateway].
	<b>IP address (Display of IP address and setting)</b>	Enter the IP address if DHCP server is not used.
	<b>Subnet mask (Displaying and setting the subnet mask)</b>	If not using a DHCP server, enter the subnet mask.
	<b>Default gateway (Display of gateway address and setting)</b>	Enter the gateway address if DHCP server is not used.
<b>DNS1 (Display of Preferred DNS server address and setting)</b>	Enter the DNS server address if DHCP server is not used.	
<b>DNS2 (Display of Alternate DNS server address and setting)</b>	Enter the alternate DNS server address if DHCP server is not used.	

- 3) Press **▲▼◀▶** to select [Set], and press **<SELECT>** button.
  - Default wired LAN settings  
The following settings are set before the projector leaves the factory.

DHCP	Off
IP address	192.168.10.100
Subnet mask	255.255.255.0
Default gateway	192.168.10.1
DNS 1/DNS 2	NONE

### Note

- Before using the DHCP server, make sure the DHCP server is already functioning.
- For details of IP address, subnet mask, gateway and DNS, ask the network administrator.

## Network

### Network control

Set when you want to control the projector from a computer connected to the network.

- 1) Press ▲▼ to select [Network control].
- 2) Press <SELECT> button to select [On] or [Off] with the ▲▼ buttons.

### Network status

This function shows the LAN setting environment of the currently selected projector.

- 1) Press ▲▼ to select [Network status].
- 2) Press <SELECT> button or the ► button to show the information of the current projector status.

### AMX D.D.

This function allows the projector to be detected by AMX Device Discovery. For more details, visit <http://www.amx.com/>.

- 1) Press ▲▼ to select [AMX D.D.].
- 2) Press <SELECT> button to select [On] or [Off] with the ▲▼ buttons.

### Network factory default

You can reset the network setting to the factory default of the projector.

- 1) Press ▲▼ to select [Network factory default], and press <SELECT> button.
- 2) A confirmation box appears and select [Yes] and then press <SELECT> button. Another confirmation box appears and select [Yes] and then press <SELECT> button.

## Network connections

The projector has a network function, and the following operations are available from the computer using the web browser control.

- Setting and adjustment of the projector.
- Display of the projector status.
- Transmission of an E-mail message when there is a problem with the projector.

### Note

- A LAN cable is required to use the network function.

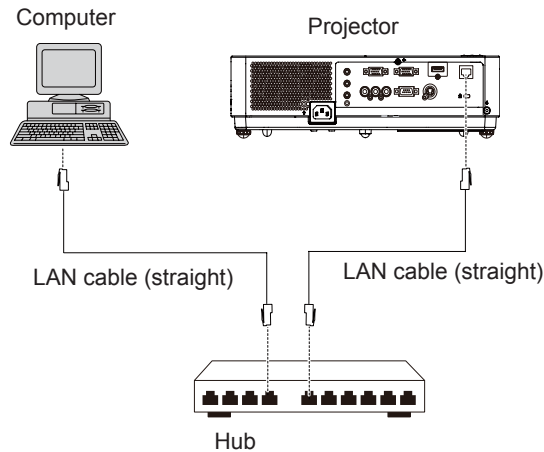

- A Web browser is required to use this function . Confirm that the Web browser can be used beforehand.  
Compatible OS : Windows XP/Windows Vista/Windows 7, Mac OS X v10.4/v10.5/v10.6/v10.7  
Compatible Web Browser : Internet Explorer 7.0/8.0/9.0, Safari 4.0/5.0 (Mac OS)
- Communication with an E-mail server is required to use the E-mail function. Confirm that the E-mail can be used beforehand.
- Use shielded LAN cable (STP cable) that is compatible with category 5 or above.
- Use a LAN cable with length of 100m or shorter.



# Network

## Computer operation

Connection can be made with wired LAN. However, confirm to your system administrator on network settings before changing any settings.

### 1) Turn on the computer.

### 2) Make the network setting according to your system administrator.

If the projector settings are the default settings (See page 57), the computer can be used with the following network settings.

DHCP	Off
IP address	192.168.10.100
Subnet mask	255.255.255.0
Default gateway	192.168.10.1
DNS 1/DNS 2	NONE

## Accessing from the Web browser

### 1) Activate the Web browser in the personal computer.

### 2) Enter the IP address set by the projector into the URL input field of the Web browser.

### 3) Enter your “User name” and “Password”.

- The factory default settings are user1 (user privileges) or admin1 (administrator privileges) for the use name and panasonic (lowercase letters) for the password.

### 4) Click [OK] to display the Projector status page.

- “Projector status” page is displayed.

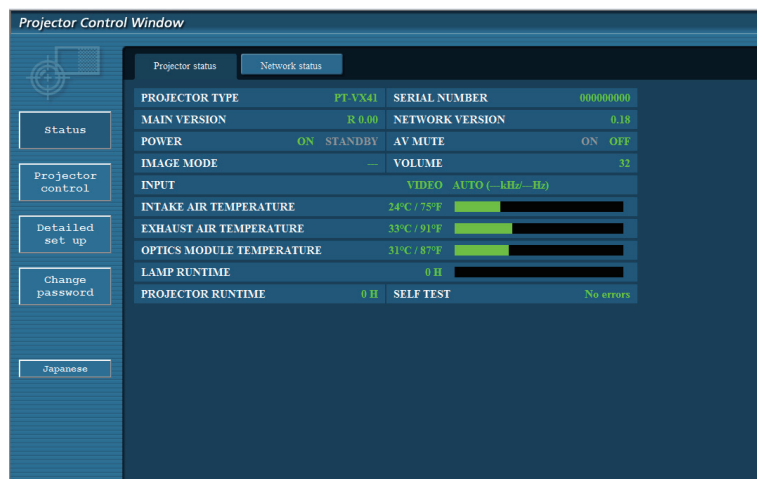
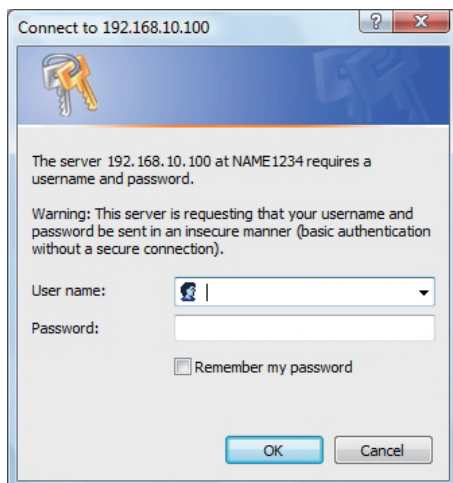

#### Note

- Avoid activating two or more Web browser simultaneously to work out setting or control actions.
- Change the password first of all.
- Administrator privileges enable the use of all functions. User privileges enable the use of only “Projector status”, “Network status”, “Basic control”, and “Change password”.
- If you want to control the projector using a Web browser, set [Network control] in the network menu to [On].
- There are some control items used with the JavaScript function in the setting pages. If the web browser is set not to use this JavaScript function, it may not control the projector properly.



## Description of each item

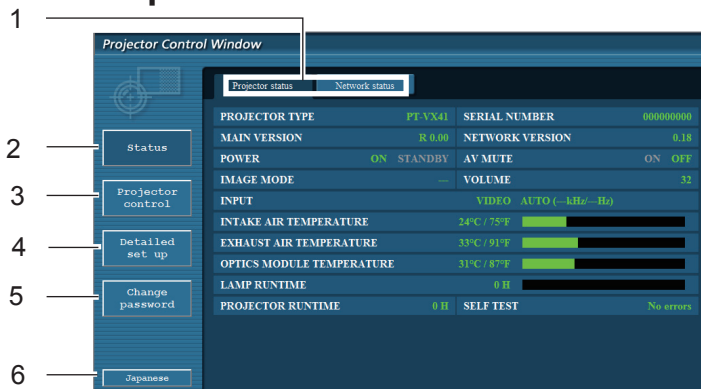

- 1 Page selection tabs  
Click these to switch pages.
- 2 Monitor information button  
Click this item, and the status of the projector is displayed.
- 3 Projector control button  
Click this item to display the projector control page.
- 4 Detailed set up button  
Click this item to display the advanced settings page.
- 5 Change password button  
Click this button to display the password change page.
- 6 Language switch button  
Click this button to switch language between English and Japanese.

## Projector status page

Click [Status], then [Projector status] to display the Status information page. This page displays the projector statuses established for the items shown below.

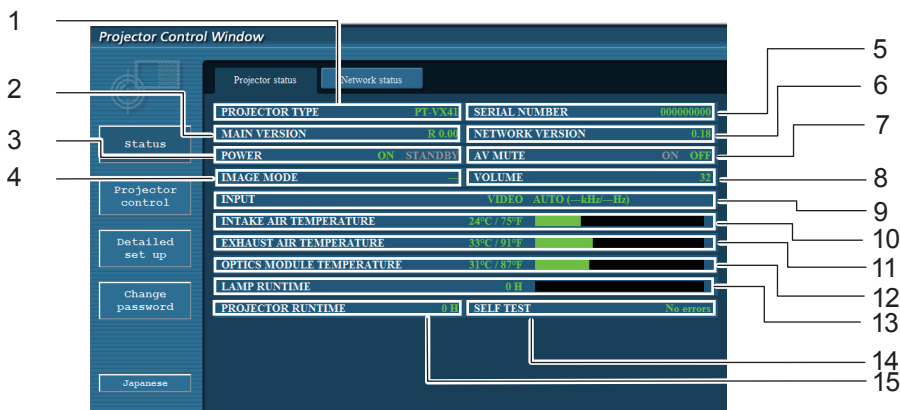

- 1 Displays the type of projector.
- 2 Displays the firmware version of the projector main unit.
- 3 Displays the power source status.
- 4 Displays the video mode status.
- 5 Displays the serial number of the projector.
- 6 Displays the firmware version of the network.
- 7 Displays the AV mute status.
- 8 Displays the volume status.
- 9 Displays the status of input switch.
- 10 Displays the intake temperature status of the projector.
- 11 Displays the exhaust temperature status of the projector.
- 12 Displays the optics module temperature status of the projector.
- 13 Displays the use time of the lamp.
- 14 Displays the self diagnostics information. (See page 62)
- 15 Displays the runtime of the projector.

## ■ Error information page

If [Error (Detail)] is displayed in the self-diagnosis information display column on the [Projector status] screen, click the part to display the details of the error.

- Depending on the nature of the error, the projector may be placed in the standby mode for its own protection.

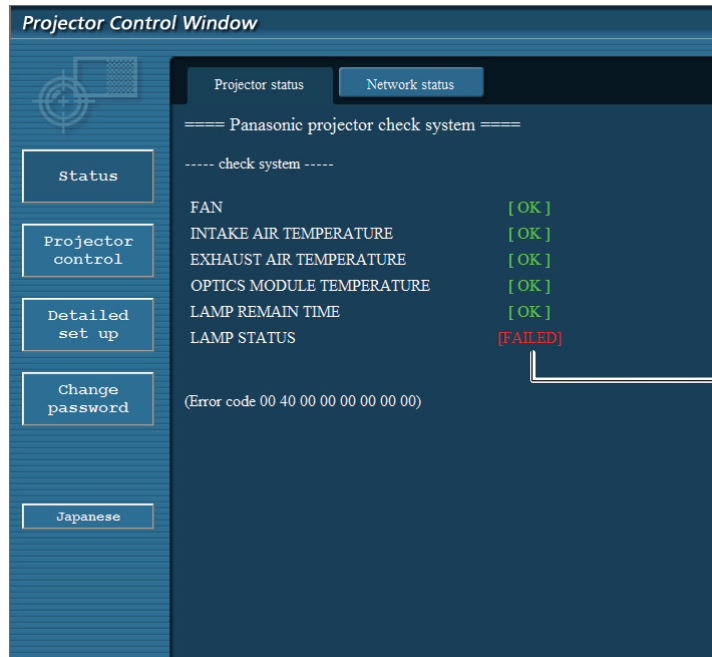

When [FAILED] has appeared for an item

Parameter	Description
FAN	Trouble has occurred in the fan or its drive circuit. Consult your dealer.
INTAKE AIR TEMPERATURE	Intake air temperature is high. It could be because it is used in an environment of high temperature such as close to a heating device, etc., the air intake is blocked, or the air filter is clogged.
EXHAUST AIR TEMPERATURE	Exhaust air temperature is high. Exhaust may be blocked, or high altitude mode may be set wrong.
OPTICS MODULE TEMPERATURE	Optics module temperature is high.
LAMP REMAIN TIME	The lamp runtime has exceeded the prescribed cumulative time, and it is now time to replace the lamp.
LAMP STATUS	The lamp has failed to light. Wait a short while for the lamp to cool off, and then turn on the power.

## Network status page

Displays the current configuration information of the network.

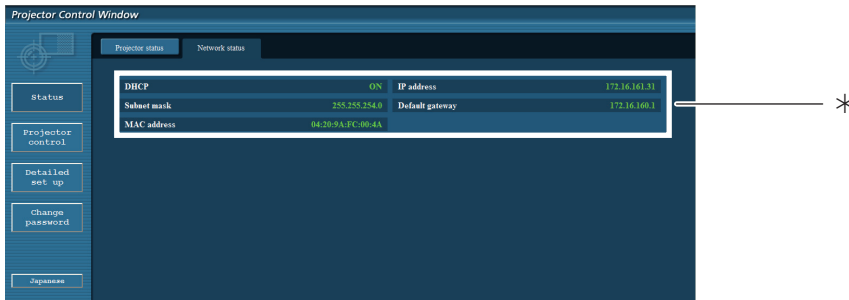

\*Displays the configuration details of wired LAN.

## Basic control page

To move from another page, click [Projector control], then [Basic control].



- 1 Power standby/on control
- 2 Use these to select the input signals
- 3 Volume adjust
- 4 Switches image mode
- 5 Operation of AV mute

## Detail control page

Click [Projector control], then [Advanced control] to display the Detail control page.



- 1 Execute Auto setup function
- 2 Operations on Screen mode
- 3 Operations on Keystone function
- 4 Operations on Rear/Ceiling
- 5 Operations on Image adjust

## Network config page

You can change network settings on projector when connecting with the administrator authority.

### ● LAN settings

- 1) Click [Detailed set up] in the menu.
- 2) Click [Change] to change the LAN settings.
  - To return to the previous window, click [Back].
- 3) Complete the detailed settings and click [Next].
  - When [Next] is clicked, the next page appears, enabling you to complete the detailed settings as desired. Settings performed here are the same as the settings performed with the [Network] menu of the projector.
- 4) Click [Submit].
  - The settings will be registered.

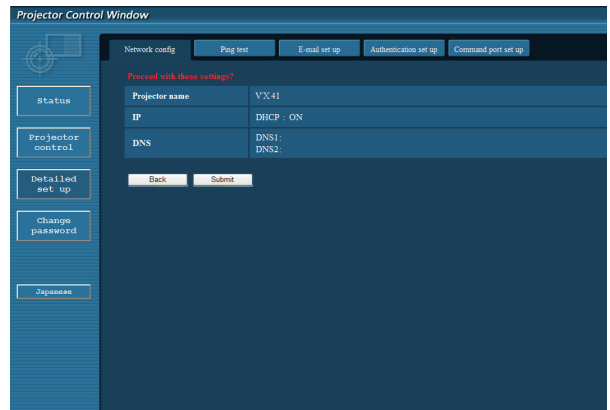
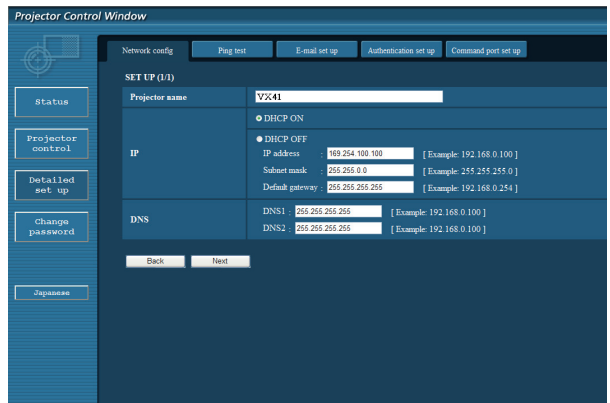
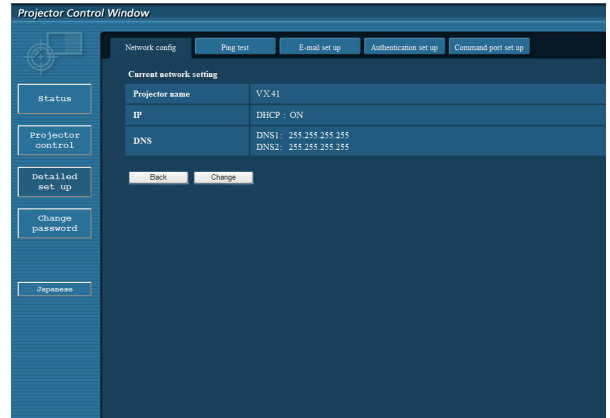

### Note

- Changing the setting of LAN while connected with LAN might disconnect the connection.

## ■ Ping test page

This page makes it possible to check whether the network is connected to the e-mail server, POP server, DNS server, etc.

Click [Detailed set up], then [Ping test] to display the Ping test page.

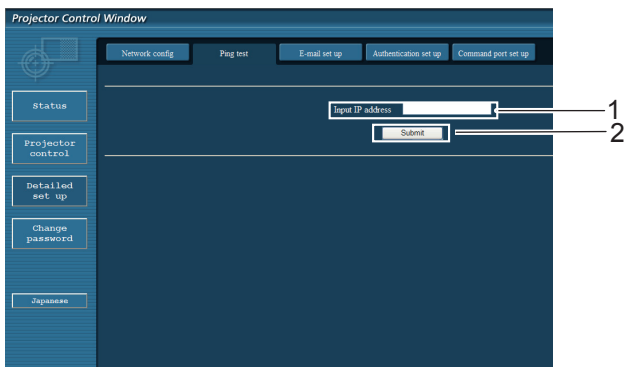

- 1 Enter the IP address of the server to be tested.
- 2 Button for conducting the test.

Display which appears when the connection was successful.

```
PING 198.245.80.20 (198.245.80.20): 56 data bytes
64 bytes from 198.245.80.20: seq=0 ttl=64 time=0.837 ms
64 bytes from 198.245.80.20: seq=1 ttl=64 time=0.483 ms
64 bytes from 198.245.80.20: seq=2 ttl=64 time=0.473 ms
64 bytes from 198.245.80.20: seq=3 ttl=64 time=0.485 ms

--- 198.245.80.20 ping statistics ---
4 packets transmitted, 4 packets received, 0% packet loss
round-trip min/avg/max = 0.473/0.571/0.837 ms
```

Display which appears when the connection failed.

```
PING 198.245.80.15 (198.245.80.15): 56 data bytes
Request timed out
Request timed out
Request timed out
Request timed out

--- 198.245.80.15 ping statistics ---
4 packets transmitted, 0 packets received, 100% packet loss
```

## E-mail set up page

With this projector, if a problem occurs or if the lamp usage time reaches a set value, an e-mail message can be sent to one or more preset e-mail addresses (maximum two addresses). Click [Detailed set up], then [E-mail set up] to display the E-mail setup page.

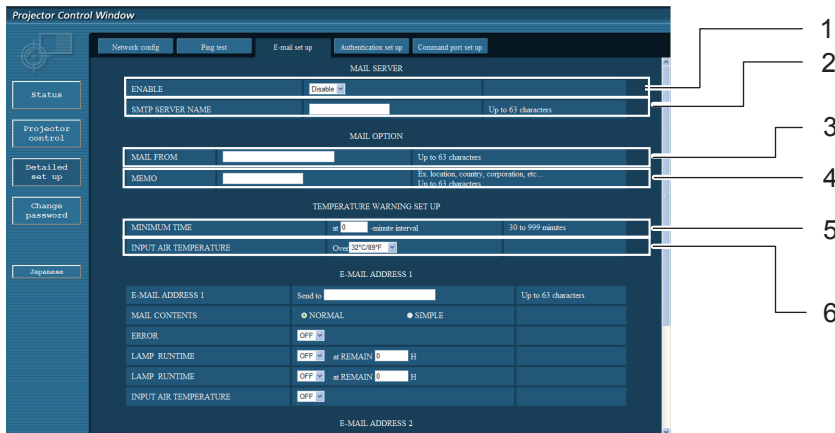

- 1 Select Enable to use the e-mail function.
- 2 Enter the IP address or server name of the e-mail server (SMTP). The DNS server must be set if the server name is entered.
- 3 Enter the e-mail address of the projector. (maximum 63 characters)
- 4 The user can enter the location of, for example, the installed projector so that the recipient may easily identify the originator of the e-mail. (maximum 63 characters)
- 5 The user can modify the minimum time interval of temperature warning mail. The default value is 60 minutes. In this case, the user cannot send another mail for 60 minutes after sending previous temperature warning mail even the set warning temperature is reached again.
- 6 Select the temperature of the intake sensor at which to send a warning message.

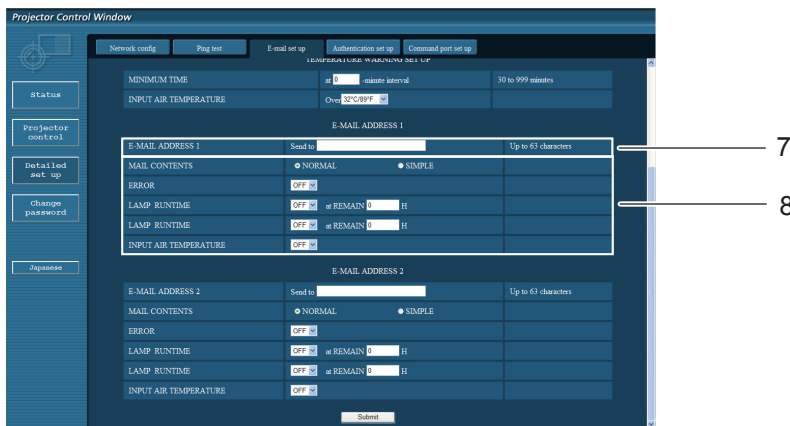

- 7 Enter the E-mail Address1 of your desired recipient.
- 8 Select the conditions for sending e-mail.

- MAIL CONTENTS:** Select [NORMAL] or [SIMPLE].
- ERROR:** An error is detected by self-diagnosis.
- LAMP RUNTIME:** Remaining lamp service time has reached the value set in the field.
- INTAKE AIR TEMPERATURE:** Intake air temperature has reached the value set in the field.

## E-mail set up page (continued)

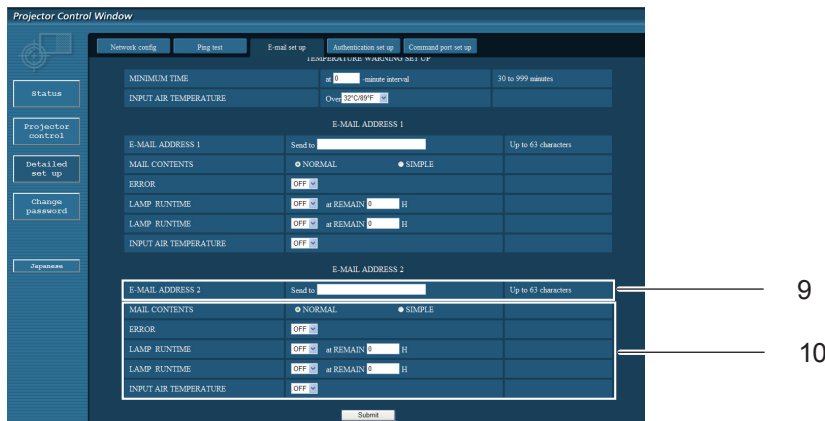

9 Enter the E-mail Address2 of your desired recipient.

10 Select the conditions for sending e-mail.

- MAIL CONTENTS:** Select [NORMAL] or [SIMPLE].
- ERROR:** An error is detected by self-diagnosis.
- LAMP RUNTIME:** Remaining lamp service time has reached the value set in the field.
- INTAKE AIR TEMPERATURE:** Intake air temperature has reached the value set in the field.

## Authentication set up page

The POP/SMTP server is set on this page when POP/SMTP authentication is required for mail transmissions. Click [Detailed set up], then [Authentication set up] to display the Authentication server setup page.

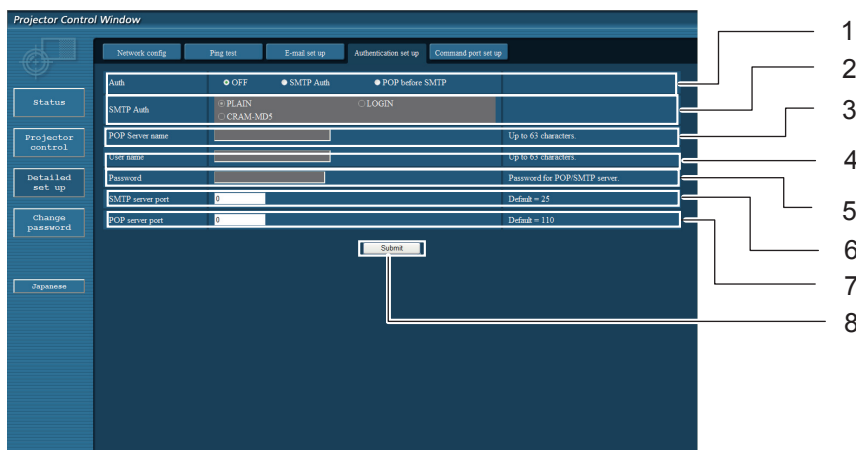

- 1 Select the authentication method specified by your Internet service provider.
- 2 Set this if SMTP authentication has been selected.
- 3 POP server name field  
Available input characters:  
Alphanumeric characters (A - Z, a - z, 0 - 9), hyphen (-), period (.)
- 4 POP/SMTP server user name field
- 5 POP/SMTP server password field
- 6 Enter the port number for the SMTP server (normally "25").
- 7 Enter the port number for the POP server (normally "110").
- 8 Button to update settings

## Contents of mail sent

- Mail with the contents shown below is sent when the e-mail settings have been established.

```
=== Panasonic projector report(CONFIGURE) ===
Projector Type      : PT-VX41
Serial No          : 123456789
----- E-mail setup data -----
TEMPERATURE WARNING SETUP
MINIMUM TIME       at [ 30] minutes interval
INTAKE AIR TEMPERATURE Over [ 32degC / 89degF ]

ERROR              [ OFF ]
LAMP RUNTIME       [ OFF ]   at REMAIN [  0] H
LAMP RUNTIME       [ OFF ]   at REMAIN [  0] H
INTAKE AIR TEMPERATURE [ OFF ]

----- check system -----
FAN                [  OK  ]
INTAKE AIR TEMPERATURE [  OK  ]
EXHAUST AIR TEMPERATURE [  OK  ]
OPTICS MODULE TEMPERATURE [  OK  ]
LAMP REMAIN TIME     [  OK  ]
LAMP STATUS          [ FAILED ]

(Error code 00 00 00 00 00 00 00 00)

Intake air temperature  :[ 10 degC /  50 degF ]
Exhaust air temperature :[ 20 degC /  68 degF ]
Optics module temperature :[ 30 degC /  86 degF ]

PROJECTOR RUNTIME      600 H

LAMP ECO              500 H
LAMP NORMAL           300 H
LAMP AUTO              0 H
LAMP REMAIN           2400 H

----- Current status -----
MAIN VERSION          1.00
NETWORK VERSION       1.00
LAMP STATUS           LAMP=ON
INPUT                 RGB
SIGNAL NAME           XGA6
SIGNAL FREQUENCY     0.00kHz / 0.00Hz

----- Wired Network configuration -----
DHCP Client          OFF
IP address           192.168.11.65
MAC address          cc:7e:e7:00:00:00

----- Memo -----
```



- Mail with the contents shown below is sent when an error has occurred.

```

=== Panasonic projector report(ERROR) ===
Projector Type      : PT-VX41
Serial No          : 123456789
----- check system -----
FAN                [   OK   ]
INTAKE AIR TEMPERATURE [   OK   ]
EXHAUST AIR TEMPERATURE [   OK   ]
OPTICS MODULE TEMPERATURE [   OK   ]
LAMP REMAIN TIME    [   OK   ]
LAMP STATUS         [ FAILED ]

(Error code 00 00 00 00 01 00 00 00)

Intake air temperature  :[ 40 degC / 104 degF ]
Exhaust air temperature :[ 30 degC /  86 degF ]
Optics module temperature :[ 70 degC / 158 degF ]

PROJECTOR RUNTIME      600 H

LAMP ECO              500 H
LAMP NORMAL           300 H
LAMP AUTO              0 H
LAMP REMAIN           2400 H

----- Current status -----
MAIN VERSION          1.00
NETWORK VERSION       1.00
LAMP STATUS           LAMP=ON
INPUT                 RGB
SIGNAL NAME           XGA6
SIGNAL FREQUENCY      0.00kHz / 0.00Hz

----- Wired Network configuration -----
DHCP Client          OFF
IP address           192.168.0.101
MAC address          08:20:9a:fc:00:51

----- Memo -----

```

## ■ Command port set up page

Set the port number to be used with command control.  
Click [Detailed set up] → [Command port set up].

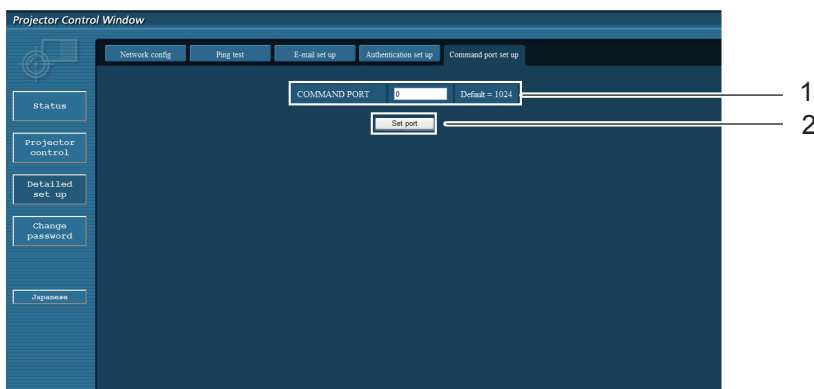

- 1 Input the port number to be used with command control
- 2 Setting update button

## Change Password page

Click [Change password].

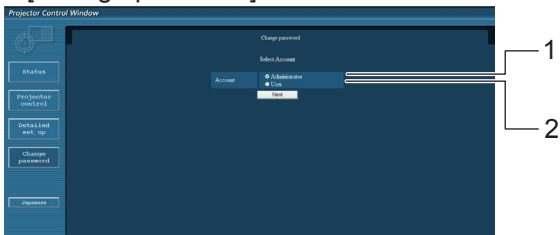

- 1 Administrator
- 2 User

## Administrator mode

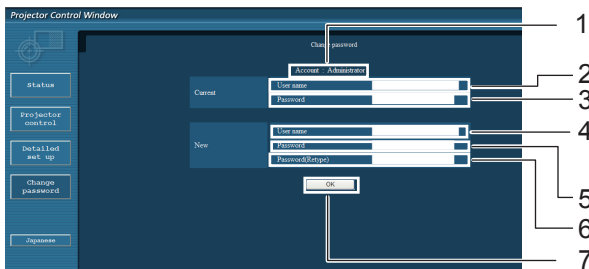

- 1 Account
- 2 Current user name input field
- 3 Current password input field
- 4 New user name input field
- 5 New password input field
- 6 New password input field (re-enter for confirmation)
- 7 Button for executing password change

## User account

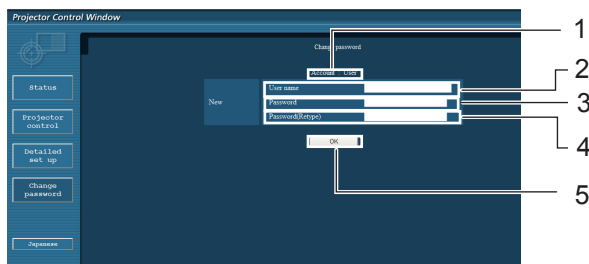

- 1 Account
- 2 New user name input field
- 3 New password input field
- 4 New password input field (re-enter for confirmation)
- 5 Button for executing password change

## User mode

A user can change password only.

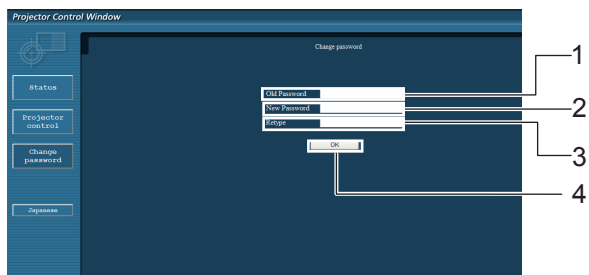

- 1 Current password input field
- 2 New password input field
- 3 New password input field (re-enter for confirmation)
- 4 Button for executing password change

### Note

- When changing the administrator account, both “Current user name” and “Current password” are required.
- No account is not available .
- Administrator account and user account should be differed.

# LAMP REPLACE and WARNING Indicators

## Managing the indicated problems

If a problem should occur inside the projector, the <POWER>, <LAMP REPLACE> and/or <WARNING> indicators will inform you. Manage the indicated problems as follow.

### CAUTION

- Before you take a remedial measure, follow the procedure of switching the power off indicated in “Turning off the projector”. (➔page 27)
- If multiple indicators light or blink, verify the status of the projector by looking at each indicator.

### Note

- Confirm the status of the power indicated on the <POWER> indicator.

## LAMP REPLACE indicator

<b>Indicator</b>	Lights in yellow.
<b>Status</b>	The projection lamp reaches its end of life.
<b>Check</b>	Is there a Lamp replacement icon appears on the screen?
<b>Remedy</b>	Replace the lamp unit. (➔page 75)

### Note

- Contact your dealer for repair services when <LAMP REPLACE> indicator persists to light after taking these measurements.

## WARNING indicator

<b>Indicator</b>	Lights in red.	Blinks in red.
<b>Status</b>	The projector detects an abnormal condition and cannot be turned on.	The temperature inside the projector is abnormally high. The projector cannot be turned on. And the <POWER> indicator also blinks in red.
<b>Check</b>	Unplug the AC power cord and plug it again to turn on the projector.	- Did you provide appropriate space for the projector to be ventilated? Check the installing condition to see if the air vents of the projector are not blocked. - Has the projector been installed near an Air-Conditioning/ Heating Duct or Vent? - Are the filters clean?
<b>Remedy</b>	If the projector is turned off again, unplug the AC power cord and contact the dealer or the service center for service and checkup.	- Provide good installing condition to your projector. - Move the installation of the projector away from the duct or vent. - Replace filters.

### Note

- If <WARNING> indicator persists to light or blink after taking these measurements, please contact your dealer for repair services. Do not leave the projector on. It may cause an electric shock or a fire hazard.
- The projector detects an abnormal condition and cannot be turned on. Unplug the AC power cord and plug it again to turn on the projector. If the projector is turned off again, unplug the AC power cord and contact the dealer or the service center for service and checkup. Do not leave the projector on. It may cause an electric shock or a fire hazard.

# Replacement

## Before replacing the unit

- When you perform maintenance or replacement of the parts, make sure to turn off the power and disconnect the power plug from the wall outlet. (➔ pages 23, 27)
- Be sure to observe the procedure “Turning off the projector” (➔ page 27) when performing power supply operation.

## Maintenance

### Outer Case

Wipe off dirt and dust using a soft dry cloth.

- If the dirt is persistent, soak the cloth with water and wring it thoroughly before wiping. Dry off the projector with a dry cloth.
- Do not use benzene, thinner, or rubbing alcohol, other solvents, household cleaners. Using them may cause deterioration of the outer case.
- When using chemical treated dusters, follow its instruction.

### Front glass surface of the lens

Wipe off the dirt and dust off the front surface of the lens with soft clean cloth.

- Do not use a cloth that has an abrasive surface or a cloth that is moist, oily, or covered with dust.
- Do not use excessive force when wiping the lens as it is fragile.

### Attention

- The lens is made of glass. Impacts or excessive force when wiping may scratch its surface. Please handle with care.

## Replacing the unit

### Air filter units

Air filter unit prevents dust from accumulating on the optical elements inside the projector. Should the air filter unit become clogged with dust particles, it will reduce cooling fans' effectiveness and may result in internal heat buildup and adversely affect the life of the projector. If the air filter units become clogged, it will result in internal heat buildup, the power of the projector may be turned off for safety.

If a “Filter warning” icon appears on the screen, replace the air filter units immediately.

Consult your dealer to purchase a replacement air filter unit (ET-RFV100).

### Replacement of the air filter units

#### 1) Remove the air filter units.

- Turn over the projector and pull out the air filter cover (bottom); pull up the handle and take out the whole filter (bottom). Press up the latches and pull out the air filter cover (side); pull out the handle and take out the side filter.

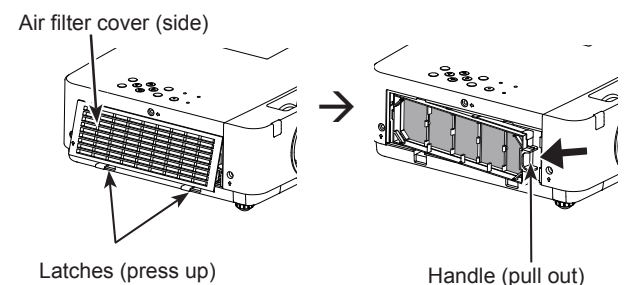
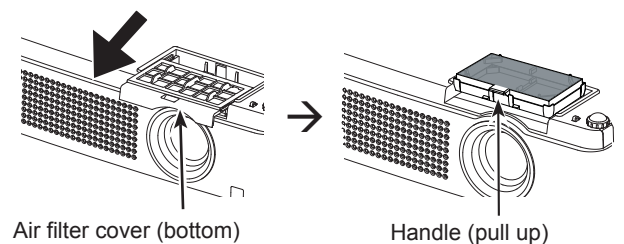

## 2) Replace the air filter units.

- Put new air filter units back into the position. Make sure that the filters are fully inserted to the projector.

## ■ Resetting the Filter Counter

Be sure to reset the Filter counter after replacing the air filter units. (➡page 55" Filter counter reset")

### Attention

- Turn off the power before you replace the air filter units.
- When attaching the air filter units, make sure that the projector is stable, and work in an environment that is safe, even in the event of the air filter units dropping.
- Do not operate the projector with the filters removed. Dust may accumulate on the optical elements degrading picture quality.
- Do not put anything into the air vents. Doing so may result in malfunction of the projector.
- Do not wash the filters with water or any other liquid matter. Otherwise the filters may be damaged.
- The air filter unit to be replaced should be an unused product.
- After replacing the air filter, reset the filter counter. Otherwise, the power of the projector may be turned off for safety.

## ■ Attaching the Air Filter Cover to the Projector

The supplied filter cover is designed for preventing dust accumulation on the filter when mounting the projector on the ceiling.

- 1) Turn over the projector.
- 2) Remove the air filter cover (bottom). (➡page 72)
- 3) Attaching the air filter cover to the projector.
  - Push the cover as the picture shown.
- 4) Attach the projector to the ceiling mount in accordance with the instruction manuals which come with the ceiling mount.

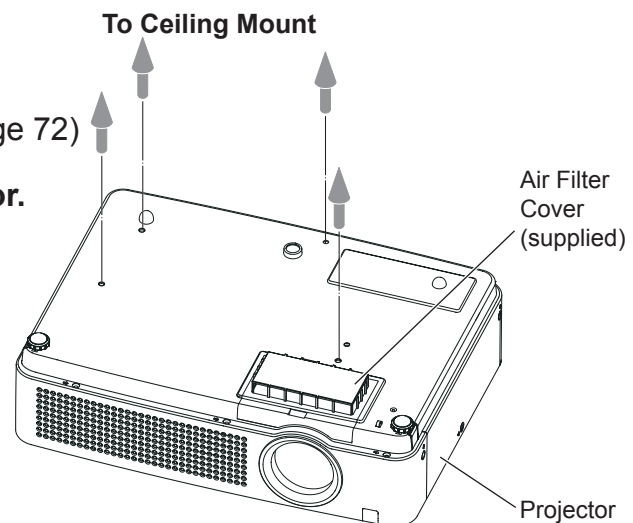

### Attention

- Please keep the air filter cover (bottom) for later use.
- If the Projector Mount Base ET-PKV100B is applied, the supplied air filter cover is unnecessary.

# Replacement

## Lamp unit

The lamp unit is a consumable component. You can check the total usage time using Lamp runtime in the Information menu on page 56.

It is recommended to ask an authorized engineer to replace the lamp unit. Contact your dealer. Consult your dealer to purchase a replacement lamp unit (ET-LAV100).

### CAUTION:

- Do not replace the lamp unit when it is hot. (Wait at least 45 minutes after use.)

The inside of the cover can become very hot, take care to avoid burn injuries.

## Notes on the replacement of the lamp unit

- The luminous source of the lamp is made of glass and may burst if you hit it against a hard surface or drop it. Please handle with care.
- A Phillips screwdriver is required for replacement of the lamp unit.
- When replacing the lamp unit, be sure to hold it by the handle.
- When replacing the lamp because it has stopped illuminating, there is a possibility that the lamp may be broken. If replacing the lamp of a projector which has been installed on the ceiling, you should always assume that the lamp is broken, and you should stand to the side of the lamp cover, not underneath it. Remove the lamp cover gently. Small pieces of glass may fall out when the lamp cover is opened. If pieces of glass get into your eyes or mouth, seek medical advice immediately.
- The lamp contains mercury. Consult your local municipality or your dealer about correct disposal of used lamp units.

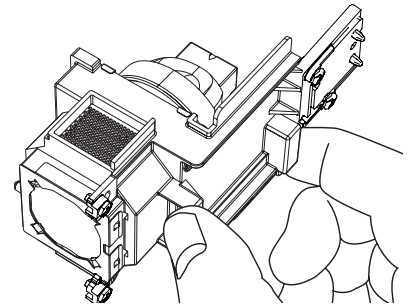



### Attention

- Do not use other than designated lamp units.
- The part numbers of accessories and separately sold components are subject to change without notice.

## When to replace the lamp unit

The lamp unit is a consumable component. Brightness decreases according to duration of usage, so periodical replacement of the lamp unit is necessary.

When the projection lamp of the projector reaches its end of life, the Lamp replacement icon appears on the screen and <LAMP REPLACE> indicator lights yellow. Replace the lamp with a new one promptly.

Lamp runtime	On screen Lamp replacement icon 	LAMP REPLACE indicator 
Over 3 000 hours *	The message is displayed for 4 seconds. If you press any button within the 4 seconds, the message disappears.	Lights in yellow (even in stand-by mode).
Over 3 200 hours *	If the power is turned on without replacing the lamp, the power automatically turns off after approximately ten minutes to prevent the malfunction of the projector.	

\*3 200 hours of use is a rough guideline, but is not a guarantee. The lamp runtime differs depending on the setting of "Lamp power" menu.

### Note

- The Lamp replacement icon will not appear when the [Display] function is set to [Off] (➔page 50), or during "Freeze" (➔page 30), or "AV mute" (➔page 31).

## ■ Replacing the Lamp unit

### CAUTION:

- When the projector is mounted on a ceiling, do not work with your face close to the projector.
- Attach the lamp unit and the lamp cover securely.
- When you experience difficulty in installing the lamp, remove it and try again. If you use force to install the lamp, the connector may be damaged.

1) Turn off the Power by following the procedure in “Turning off the projector (→page 27)”. Unplug the AC power cord. Wait at least 45 minutes and make sure the lamp unit and surroundings are cool.

2) Use a Phillips screwdriver to loosen the lamp cover fixing screw and open the lamp cover.

- Open the lamp cover by pulling it slowly toward the direction of the arrow.

3) Use a Phillips screwdriver to loosen the three lamp unit fixing screws until the screws turn freely. Hold the used lamp unit by its handles, and pull it gently from the projector.

4) Insert the new lamp unit in correct direction. Tighten the three lamp unit fixing screws securely with a Phillips screwdriver.

5) Close the lamp cover, and tighten the lamp cover fixing screw securely with a Phillips screwdriver.

- Close the lamp cover by pushing it slowly opposite the direction of the arrow.

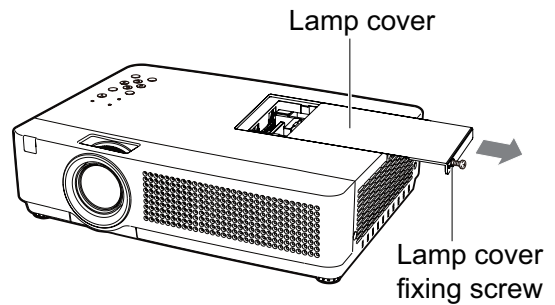

Lamp unit fixing screws

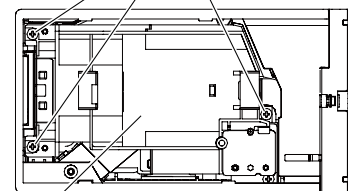

Lamp unit

Handles

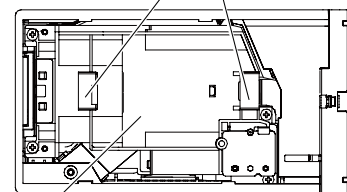

Lamp unit

### Note

- When you replace the new lamp unit (ET-LAV100), the projector resets the total usage time of the lamp unit automatically.

# Replacement

## Attaching the Lens Cap

When moving this projector or while not using it over an extended period of time, attach the lens cap. Attach the lens cap according to the following procedures.

- 1) Thread the string (supplied) through the hole on the lens cap.
- 2) Push the other end of the string into the front part of the hook (as the picture shown) on the bottom of the projector.

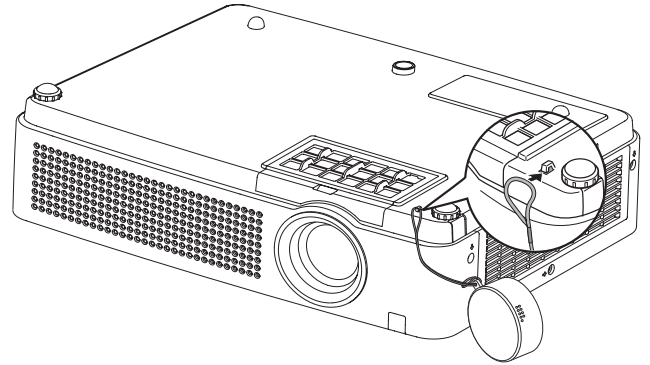



# Troubleshooting

Please check following points. For details, see the corresponding pages.

Problem	Cause	Reference page
<b>Power does not turn on.</b>	● The power cord may not be connected.	—
	● No electric supply is at the wall outlet.	—
	● The circuit breakers have tripped.	—
	● Is the <LAMP REPLACE> indicator, <POWER> indicator, or <WARNING > indicator lit or blinking?	24, 71
	● The lamp cover has not been securely installed.	75
<b>No picture appears.</b>	● The video signal input source may not be connected to a terminal properly.	22
	● The input selection setting may not be correct.	29
	● The [Brightness] adjustment setting may be at the minimum setting.	42
	● The input source which is connected to the projector may have a problem.	—
	● The [AV mute] function may be in use.	31
<b>The picture is fuzzy.</b>	● The lens focus may not have been set correctly.	28
	● The projector may not be at the correct distance from the screen.	20
	● The lens may be dirty.	12
	● The projector may be tilted too much.	—
	● The lens cap is still attached to the lens.	13
<b>The color is pale or grayish.</b>	● [Color] or [Tint] adjustment may be incorrect.	42
	● The input source which is connected to the projector may not be adjusted correctly.	—
	● RGB cable is damaged.	—
<b>No sound from the internal speaker</b>	● The input terminals may not have been correctly connected.	22
	● The volume may have been set to the minimum level.	31, 48
	● The [AV mute] function may have been turned on.	31
	● When the AUDIO OUT is plugged-in, the projector's built-in speaker is not available.	17
	● The [Mute] function may have been turned on.	32, 48
<b>The remote control does not operate.</b>	● The batteries may be weak.	—
	● The batteries may not have been inserted correctly.	18
	● The remote control signal receiver on the projector may be obstructed.	15
	● The remote control unit may be out of the operation range.	15
	● Strong light such as fluorescent shine onto the signal receptor.	15
	● When different codes are set on the projector and on the remote control.	54
<b>The control buttons of the projector do not operate.</b>	● The control panel is not available if the control panel is locked at [Key lock] under [Security] of [Setting] section.	53
<b>The picture does not display correctly.</b>	● There may be a problem with the VCR or other signal source.	—
	● A signal which is not compatible with the projector is being input.	86-89
<b>Picture from a computer does not appear.</b>	● The cable may be longer than the optional cable.	—
	● The external video output from a laptop computer may not be correct.	—

# Troubleshooting

Problem	Cause	Reference page
<b>Picture from a HDMI device does not appear or picture is not stable.</b>	● Is the HDMI cable securely connected?	22
	● Turn off the power of the projector and the connected devices. Then turn the power of the projector and the connected devices back on.	—
	● Isn't unsupported signal cable connected?	86-89
<b>No sound is output from a HDMI device.</b>	● Set the sound channel of the attached device to Linear PCM.	—
	● If no audio signal is output during HDMI cable connection, connect the audio cable to COMPUTER AUDIO IN 2 terminal and set to "Computer 2" in "Sound" of "Setting" menu.	51
<b>The image is distorted or runs off.</b>	● Check [PC adj.] or [Screen] and adjust them.	39, 45
<b>The exclamation mark  appears on the screen.</b>	● Your operation is invalid. Operate correctly.	—

## Note

- If the problem persists, after confirming the contents of the table, please consult your dealer.

# Technical Information

## PJLink protocol

The network function of the projector supports PJLink class 1, and the PJLink protocol can be used to perform projector setting and projector status query operations from a computer.

### ■ Control commands

The following table lists the PJLink protocol commands that can be used to control the projector.

Command	Control details	Notes
POWR	Power supply control	Parameters 0 = Standby 1 = Power ON
POWR ?	Power supply status query	Parameters 0 = Standby      1 = Power ON 2 = Cool-down in progress
INPT	Input selection	Parameters
INPT ?	Input selection query	11 = RGB 1      12 = RGB(Scart)      13 = RGB 2 21 = VIDEO      22 = COMPONENT      25 = S-VIDEO 33 = HDMI
AVMT	AV MUTE control	Parameters
AVMT ?	AV MUTE status query	30 = AV MUTE mode off 31 = AV MUTE mode on
ERST ?	Error status query	Parameters 1st byte : Indicates fan errors, range 0 – 2 2nd byte : Indicates lamp errors, range 0 – 2 3rd byte : Indicates temperature errors, range 0 – 2 4th byte : Fixed at 0 5th byte : Indicates filter errors, range 0 – 2 6th byte : Indicates other errors, range 0 – 2  Definitions for each value from 0 to 2 are as follows. 0 = No error known      1 = Warning      2 = Error
LAMP ?	Lamp status query	Parameters 1st digits (1 – 5 digits) : Lamp cumulative operating time 2nd digit : 0 = Lamp off, 1 = Lamp on
INST ?	Input selection list query	The followings are returned as parameters. [11, 12, 13, 21, 22, 25, 33]
NAME ?	Projector name query	The name set for [Projector name] in [Network] is returned.
INF1 ?	Manufacturer name query	“Panasonic” is returned.
INF2 ?	Model name query	Answer the model name with “VX41”.
INF0 ?	Other information query	Information such as version number is returned.
CLSS ?	Class information query	“1” is returned.

### ■ PJLink security authorization

When using PJLink with security authorization, either of the password set for administrator privileges and the password set for user privileges with Web browser control can be used as the password for PJLink (See page 70).

When using PJLink without security authorization, set use without the password for administrator privileges and the password for user privileges of Web browser control.

**For specifications regarding PJLink, refer to the Japan Business Machine and Information System Industries Association website.**

**URL <http://pjlink.jbmia.or.jp/>**

## Control commands via LAN

### ■ When WEB Control administrator rights password is set (Protect mode)

#### ● Connection method

- 1) Obtain the IP address and port number (Initial set value = 1 024) of the projector and make a request for connection to the projector.

Acquire the IP address from the menu screen of the projector, and the port number from the WEB control page.

**IP address :** Obtain from MAIN MENU → [Network] → [Network status]

**Port No. :** Acquire from the WEB control “Detailed set up” → “Command port set up” page

- 2) There is a response from the projector.

Response data

Data section	Blank	Mode	Blank	Random number section	Termination symbol
“NTCONTROL” (ASCII string)	‘ ’ 0x20	‘1’ 0x31	‘ ’ 0x20	“ZZZZZZZ” (ASCII code hexadecimal number)	(CR) 0x0d
9 bytes	1 byte	1 byte	1 byte	8 bytes	1 byte

Mode : 1 = Protect mode

- 3) Generate a 32-byte hash value from the following data using MD5 algorithm.

“xxxxxx:yyyyy:zzzzzzz”

xxxxxx : Administrator rights user name for WEB CONTROL (Default user name is “admin1”)

yyyyy : Password of above administrator rights user (Default password is “panasonic”)

zzzzzzz : 8-byte random number obtained in Step 2

#### ● Command transmission method

Transmit using the following command format.

Transmitted data

Header		Data section		Termination symbol
Hash value (See above <Connection method>)	‘0’ 0x30	‘0’ 0x30	Control command (ASCII string)	(CR) 0x0d
32 bytes	1 byte	1 byte	Undefined length	1 byte

Receive data

Header		Data section		Termination symbol
‘0’ 0x30	‘0’ 0x30	Control command (ASCII string)	(CR) 0x0d	
1 byte	1 byte	Undefined length	1 byte	

Error response

Error message	Termination symbol
“ERR1” “ERR2” “ERR3” “ERR4” “ERR5” “ERRA”	(CR) 0x0d
Undefined control command Out of parameter range Busy state or no-acceptable period Timeout or no-acceptable period Wrong data length Password mismatch	
4 bytes	1 byte

## ■ When WEB Control administrator rights password is not set (Non-protect mode)

### ● Connection method

- 1) Obtain the IP address and port number (Initial set value = 1 024) of the projector and make a request for connection to the projector.

Acquire the IP address from the menu screen of the projector, and the port number from the WEB control page.

**IP address :** Obtain from MAIN MENU → [Network] → [Network status]

**Port No. :** Acquire from the WEB control “Detailed set up” → “Command port set up” page

- 2) There is a response from the projector.

#### Response data

Data section	Blank	Mode	Termination symbol
“NTCONTROL” (ASCII string)	‘ ’ 0x20	‘0’ 0x30	(CR) 0x0d
9 bytes	1 byte	1 byte	1 byte

Mode : 0 = Non-protect mode

### ● Command transmission method

Transmit by the following command format.

#### Transmitted data

Header		Data section	Termination symbol
‘0’ 0x30	‘0’ 0x30	Control command (ASCII string)	(CR) 0x0d
1 byte	1 byte	Undefined length	1 byte

#### Receive data

Header		Data section	Termination symbol
‘0’ 0x30	‘0’ 0x30	Control command (ASCII string)	(CR) 0x0d
1 byte	1 byte	Undefined length	1 byte

#### Receive data

Error message	Termination symbol
“ERR1” Undefined control command	(CR) 0x0d
“ERR2” Out of parameter range	
“ERR3” Busy state or no-acceptable period	
“ERR4” Timeout or no-acceptable period	
“ERR5” Wrong data length	
“ERRA” Password mismatch	
4 bytes	1 byte

# Technical Information

## Serial terminal

The serial connector which is on the connector panel of the projector conforms to the RS-232C interface specification, so that the projector can be controlled by a personal computer which is connected to this connector.

### ■ Connection

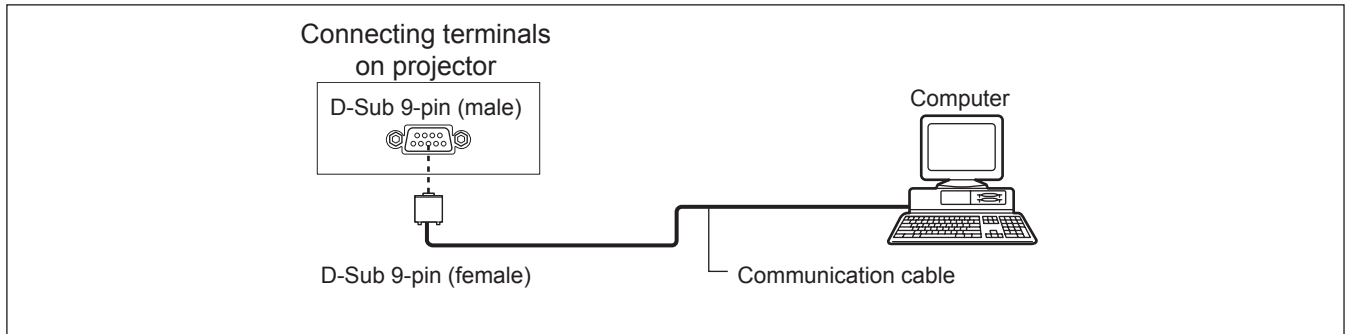

### ■ Pin assignments and signal names

D-Sub 9-pin (male) Outside view	Pin No.	Signal name	Contents
	①	—	NC
	②	RXD	Received data
	③	TXD	Transmitted data
	④	—	NC
	⑤	GND	Earth
	⑥	—	NC
	⑦	—	NC
	⑧	—	NC
	⑨	—	NC

### ■ Communication conditions

Signal level	RS-232C-compliant
Sync. method	Asynchronous
Baud rate	19 200 bps
Parity	None

Character length	8 bits
Stop bit	1 bit
X parameter	None
S parameter	None

#### Note

- When [AMX D. D.] function is set to [On] under the [Network] menu, the Baud rate will change to 9 600 bps automatically.

**Basic format**

Transmission from the computer begins with STX, then the command, parameter, and ETX are sent in this order. Add parameters according to the details of control.

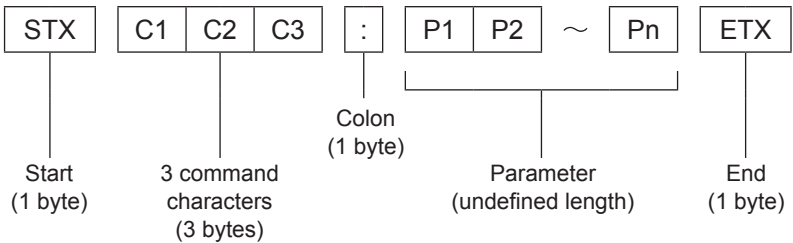

\*: When sending commands without parameters, a colon (:) is not necessary.

**Basic format (with sub command)**

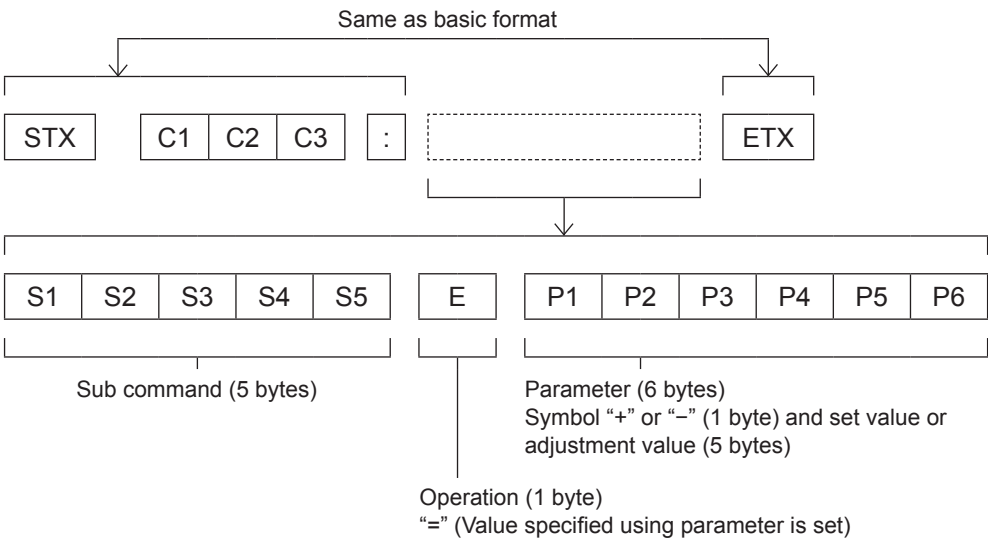

\*: When transmitting a command which does not need a parameter, the operation (E) and parameter are not necessary.

## ■ Cable specifications

[When connected to a computer]

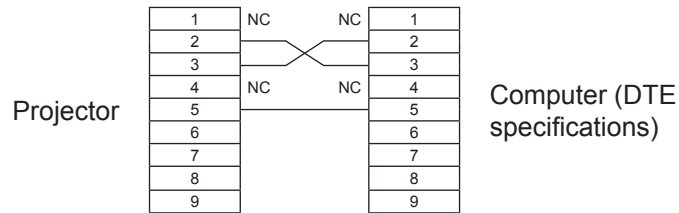

## ■ Control commands

When controlling the projector from a computer, the following commands are available:

[Projector control command]

Command	Control contents	Remarks
PON	Power [ON]	
POF	Power [OFF]	
IIS	INPUT selection	(Parameter) VID = Video SVD = S-video RG1 = Computer 1(RGB) RG2 = Computer 2(RGB) HD1 = HDMI SCT = Computer 1(Scart)
OSH	AV mute function	Turn off the projection and sound temporarily. Do not send the command consecutively. (Parameter) 0 = AV MUTE mode off 1 = AV MUTE mode on
OFZ	Freeze	(Parameter) 0 = Freeze mode off 1 = Freeze mode on
AUU	Volume up	
AUD	Volume down	
DZU	D. ZOOM up	
DZD	D. ZOOM down	
QPW	Power query	000 = Standby 001 = Power on
Q\$S	Lamp condition query	(Call back) 0 = Stand-by 1 = Lamp [ON] control active 2 = Lamp [ON] 3 = Lamp [OFF] control active



## Other terminals

### Pin assignments and signal names of <S-VIDEO IN> terminal

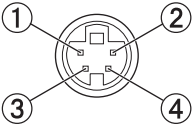
Outside view	Pin No.	Signal names
	①	GND (luminance signal)
	②	GND (color signal)
	③	Luminance signal
	④	Color signal

### Pin assignments and signal names of <COMPUTER IN 1/COMPONENT IN> terminal

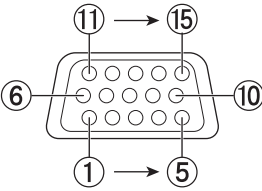
Outside view	Pin No.	Signal names
	①	R/P <sub>R</sub>
	②	G/G · SYNC/Y
	③	B/P <sub>B</sub>
	⑨	+ 5 V
	⑫	DDC data
	⑬	HD/SYNC
	⑭	VD
	⑮	DDC clock
	④	
	⑤ - ⑧, ⑩, ⑪	

④ : Not assigned  
⑤ - ⑧, ⑩, ⑪ : GND terminals

### Pin assignments and signal names of <COMPUTER IN 2/MONITOR OUT> terminal

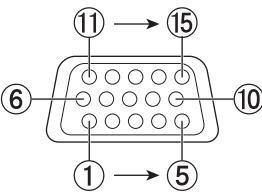
Outside view	Pin No.	Signal names
	①	R/P <sub>R</sub>
	②	G/G · SYNC/Y
	③	B/P <sub>B</sub>
	⑬	HD/SYNC
	⑭	VD
	④	
	⑤ - ⑧, ⑩, ⑪	
	⑨	
	⑫	
	⑮	

④, ⑨, ⑪, ⑫, ⑮ : Not assigned  
⑤ - ⑧, ⑩ : GND terminals

### Pin assignments and signal names of <HDMI> terminal

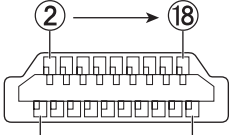
Outside view	Pin No.	Signal names	Pin No.	Signal names
<p>Even-numbered pins ② to ⑮</p>  <p>Odd-numbered pins ① to ⑲</p>	①	T.M.D.S data 2+	⑪	T.M.D.S clock shield
	②	T.M.D.S data 2 shield	⑫	T.M.D.S clock -
	③	T.M.D.S data 2-	⑬	CEC
	④	T.M.D.S data 1+	⑭	—
	⑤	T.M.D.S data 1 shield	⑮	SCL
	⑥	T.M.D.S data 1-	⑯	SDA
	⑦	T.M.D.S data 0+	⑰	DDC/CEC GND
	⑧	T.M.D.S data 0 shield	⑱	+5V
	⑨	T.M.D.S data 0-		Hot plug detection
	⑩	T.M.D.S clock +		

# Technical Information

## List of compatible signals

The following table specifies the types of signals compatible with the projectors.  
Format : V = VIDEO, S = S-VIDEO, C = COMPUTER, Y = YP<sub>B</sub>P<sub>R</sub>, H = HDMI

Mode	Display resolution *1 (dots)	Scanning frequency		Dot clock frequency (MHz)	Picture quality *2	PnP*3	Format
		H (kHz)	V (Hz)				
NTSC/NTSC 4.43/ PAL-M/PAL 60	720 x 480	15.7	59.9	--	A		V/S
PAL/PAL-N/SECAM	720 x 576	15.6	60.0	--	A		V/S
480p	640 x 480	31.47	59.88	25.2	A		C/Y
480i	640 x 480i	15.734	60.00	12.2727	A		
576p	768 x 576	31.25	50.00	29.5	A		
576i	768 x 576i	15.625	50.00	14.75	A		
720p	1 280 x 720	37.50	50.00	74.25	A		
		45.00	60.00	74.25	A		
1 035i	1 920 x 1 035i	33.75	60.00	74.25	A		
1 080/50	1 920 x 1 080	28.125	50.00	74.25	A		
		33.75	60.00	74.25	A		
VGA	640 x 480	31.47	59.88	25.149	A	○	
		37.86	74.38	31.50	A		
		37.86	72.81	31.50	A	○	
		37.50	75.00	31.50	A	○	
		43.269	85.00	36.00	A		
	640 x 400	31.47	70.09	25.175	A		
720 x 400	31.47	70.09	28.322	A			
SVGA	800 x 600	35.156	56.25	36.00	A	○	
		37.88	60.32	40.00	A	○	
		46.875	75.00	49.50	A	○	
		53.674	85.06	56.25	A		
		48.08	72.19	50.00	A	○	
		37.90	61.03	40.02	A		
		34.50	55.38	36.432	A		
		38.00	60.51	40.128	A		
		38.60	60.31	38.60	A		
		32.70	51.09	32.70	A		
38.00	60.51	40.128	A				
MAC	1 280 x 960	75.00	75.08	126.00	A		
	1 280 x 1 024	80.00	75.08	135.20	A		
MAC 13	640 x 480	35.00	66.67	30.24	A		
MAC LC13	640 x 480	34.97	66.60	31.33	A		
MAC 16	832 x 624	49.72	74.55	57.283	A		
MAC 19	1 024 x 768	60.24	75.08	80.01	A		
MAC 21	1 152 x 870	68.68	75.06	100.00	A		

\*1 : "i" added to the resolution value indicates an interlaced signal.

\*2 : Picture quality is indicated by the following symbols.

AA: Maximum picture quality can be obtained.

A: Signals are converted by the image processing circuit.

\*3 : The signal marked with circles (O) can be applied by plug-and-play device.

# Technical Information

Mode	Display resolution *1 (dots)	Scanning frequency		Dot clock frequency (MHz)	Picture quality *2	PnP*3	Format
		H (kHz)	V (Hz)				
SXGA+	1 400 x 1 050	63.970	60.190	107.990	A		C
		65.350	60.120	122.850	A		
		65.120	59.900	122.430	A		
XGA	1 024 x 768	48.36	60.00	65.00	AA	○	
		68.677	84.977	94.504	AA		
		60.023	75.03	78.75	AA	○	
		56.476	70.07	75.00	AA	○	
		60.31	74.92	79.252	AA		
		48.50	60.02	65.179	AA		
		44.00	54.58	59.129	AA		
		63.48	79.35	83.41	AA		
		62.04	77.07	84.375	AA		
		61.00	75.70	81.00	AA		
		46.90	58.20	63.03	AA		
	47.00	58.30	61.664	AA			
	58.03	72.00	74.745	AA			
1 024 x 768i	36.00	87.17	47.30	AA			
	35.522	86.96	44.90	AA			
SXGA	1 152 x 864	64.20	70.40	94.560	A		
	1 152 x 900	61.20	65.20	92.00	A		
		71.40	75.60	105.10	A		
	1 280 x 960	61.85	66.00	94.50	A		
		60.00	60.00	108.00	A		
	1 280 x 1 024	62.50	58.60	108.00	A		
		63.90	60.00	107.35	A		
		63.34	59.98	108.18	A		
		63.74	60.01	109.497	A		
		71.69	67.19	117.004	A		
		81.13	76.107	135.008	A		
		63.98	60.02	108.00	A		
		79.976	75.025	135.00	A		
		63.37	60.01	111.520	A		
		76.97	72.00	130.08	A		
		63.79	60.18	108.19	A		
	91.146	85.024	157.5	A			
1 280 x 1 024i	50.00	86.00	80.00	A			
	50.00	94.00	80.00	A			
	46.43	86.70	78.745	A			
UXGA	1 600 x 1 200	75.00	60.00	162.00	A		
		81.25	65.00	175.50	A		
		87.5	70.00	189.00	A		
		93.75	75.00	202.50	A		

\*1 : "i" added to the resolution value indicates an interlaced signal.

\*2 : Picture quality is indicated by the following symbols.

AA: Maximum picture quality can be obtained.

A: Signals are converted by the image processing circuit.

\*3 : The signal marked with circles (O) can be applied by plug-and-play device.

# Technical Information

Mode	Display resolution *1 (dots)	Scanning frequency		Dot clock frequency (MHz)	Picture quality *2	PnP*3	Format
		H (kHz)	V (Hz)				
WXGA	1 280 x 768	47.776	59.870	79.500	A		C
		60.289	74.893	102.250	A		
		68.633	84.837	117.500	A		
		55.993	69.991	94.964	A		
		57.675	72.004	97.817	A		
	1 280 x 800	49.600	60.050	79.360	A		
		41.200	50.000	68.557	A		
		49.702	59.810	83.500	A	○	
		63.980	60.020	108.000	A		
		58.289	69.975	98.858	A		
		60.044	71.995	102.795	A		
		62.790	74.928	106.492	A		
	71.553	84.879	122.498	A			
	1 366 x 768	48.36	60.00	86.67	A		
	1 360 x 768	47.70	60.00	86.67	A		
56.16		72.00	100.19	A			
1 376 x 768	48.36	60.00	86.67	A			
WSXGA+	1 680 x 1 050	65.290	59.954	146.250	A		
WXGA+	1 440 x 900	55.935	59.887	106.500	A		
		74.918	60.000	161.850	A		
WUXGA	1 920 x 1 200	74.556	59.885	193.250	A		
		74.038	59.950	154.000	A		
D-VGA	640 x 480	31.47	59.94	25.175	A	○	
D-480p		31.47	59.88	25.2	A	○	
D-576p	768 x 576	31.25	50.00	29.5	A	○	
D-720p	1 280 x 720	37.50	50.00	74.25	A	○	
		45.00	60.00	74.25	A	○	
D-SVGA	800 x 600	37.879	60.32	40.00	A	○	
D-XGA	1 024 x 768	43.363	60.00	65.00	AA	○	
D-SXGA+	1 400 x 1 050	63.97	60.19	107.99	A		
		65.350	60.120	122.850	A		
		65.120	59.900	122.430	A		

\*1 : "i" added to the resolution value indicates an interlaced signal.

\*2 : Picture quality is indicated by the following symbols.

AA: Maximum picture quality can be obtained.

A: Signals are converted by the image processing circuit.

\*3 : The signal marked with circles (O) can be applied by plug-and-play device.

Mode	Display resolution *1 (dots)	Scanning frequency		Dot clock frequency (MHz)	Picture quality *2	PnP*3	Format
		H (kHz)	V (Hz)				
D-WXGA	1 360 x 768	47.700	60.00	86.670	A		H
		56.160	72.000	100.190	A		
	1 366 x 768	46.500	50.000	67.400	A		
		48.360	60.00	86.670	A		
	1 376 x 768	48.360	60.00	86.670	A		
	1 280 x 768	47.776	59.870	79.500	A		
		60.289	74.893	102.250	A		
		68.633	84.837	117.500	A		
		55.993	69.991	94.964	A		
		57.675	72.004	97.817	A		
	1 280 x 800	49.572	59.870	83.282	A		
		41.200	50.000	68.557	A		
		49.702	59.810	83.500	A	○	
		63.980	60.020	108.000	A		
		58.289	69.975	98.858	A		
		60.044	71.995	102.795	A		
62.790		74.928	106.492	A			
	71.553	84.879	122.498	A			
D-SXGA	1 280 x 1 024	63.98	60.02	108	A		
		60.276	58.069	93.067	A		
		31.65	29.8	53.48	A		
D-1 035i	1 920 x 1 035i	33.75	60.00	74.25	A		
D-1 080i	1 920 x 1 080i	28.125	50.00	74.25	A	○	
		33.75	60.00	74.25	A	○	
D-1 080p	1 920 x 1 080	67.5	60.00	148.5	A		
		56.25	50.00	148.5	A		
D-WXGA+	1 440 x 900	55.935	59.887	106.500	A		
D-WSXGA+	1 680 x 1 050	65.290	59.954	146.250	A		
D-WUXGA	1 920 x 1 200	74.038	59.950	154.000	A		

\*1 : "i" added to the resolution value indicates an interlaced signal.

\*2 : Picture quality is indicated by the following symbols.

AA: Maximum picture quality can be obtained.

A: Signals are converted by the image processing circuit.

\*3 : The signal marked with circles (O) can be applied by plug-and-play device.

## Note

- The number of display dots is 1 024 x 768.  
A signal with a different resolution will be projected after converting the resolution to match the projector display.
- When interlaced signals are connected, flicker may occur on the projected image.

# Specifications

Model No.		PT-VX41E
Power supply		AC100 V - 240 V 50 Hz/60 Hz
Power consumption		100 V - 240 V 3.8 A-1.8 A 322 W
		When [Standby mode] of [Setting] is set to [Eco]: 0.48W
		When [Standby mode] of [Setting] is set to [Network]: 10.0W
		When [Standby MIC out] of [Sound] is set to [On]: Max.26 W
LCD panel	Panel size	1.6 cm (0.63") (aspect ratio 4 : 3)
	Display method	3 transparent LCD panels (RGB)
	Drive method	Active matrix method
	Pixels	786 432 (1 024 x 768) x 3 panels
Lens		Manual zoom (1.2x) / Manual focus F 1.60 to 1.76, f 22.33 mm to 26.80 mm
Luminous lamp		245 W UHM lamp
Light output *1		4 000 lm
Applicable scanning frequency *2	for RGB signal	Horizontal 15 kHz to 100 kHz, Vertical 50 Hz to 100 Hz Dot clock frequency: 140 MHz or less
	for YP <sub>B</sub> P <sub>R</sub> signal	[525i(480i)] Horizontal 15.75 kHz, Vertical 60 Hz [525p(480p)] Horizontal 31.5 kHz, Vertical 60 Hz [750(720)/60p] Horizontal 45 kHz, Vertical 60 Hz [1 125(1 080)/60i] Horizontal 33.75 kHz, Vertical 60 Hz [625i(576i)] Horizontal 15.63 kHz, Vertical 50 Hz [625p(576p)] Horizontal 31.25 kHz, Vertical 50 Hz [750(720)/50p] Horizontal 37.5 kHz, Vertical 50 Hz [1 125(1 080)/50i] Horizontal 28.13 kHz, Vertical 50 Hz ● HD/SYNC and V terminals are not compliant with 3 value composite SYNC
	for Video signal (including S-video)	Horizontal 15.75 kHz / 15.63 kHz, Vertical 50 Hz / 60 Hz
	for HDMI signal	525p(480p), 625p(576p), 750(720)/60p, 750(720)/50p, 1 125(1 080)/60p, 1 125(1 080)/50p, 1 125(1 080)/60i, 1 125(1 080)/50i ● Displayable resolution: VGA to WUXGA (non-interlace) ● Dot clock frequency: up to 162 MHz
	Color system	7 (NTSC, NTSC4.43, PAL, PAL-N, PAL-M, SECAM, PAL60)
Projection size		1.02 m -7.62 m (40"-300")
Screen aspect ratio		4 : 3
Projection scheme		Front / Rear / Mount on Ceiling / Floor (Menu setting system)
Speaker		1 (3.7 cm round-type)
Maximum usable volume output		10W
Contrast ratio *1		2 000 : 1 (all white / all black)

\*1 : Measurement, measuring conditions and method of notation all comply with ISO21118 international standards.

\*2 : For details of video signals that can be projected using this projector, refer to "List of compatible signals". (➡ pages 86-89)

# Specifications

Model No.		PT-VX41E
Terminals	COMPUTER IN 1/ COMPONENT IN	1 (D-sub 15 pin female) [RGB signal] 0.7 V [p-p] 75 Ω (When G-SYNC: 1.0 [p-p] 75 Ω HD/SYNC TTL high impedance, automatic positive/negative polarity compatible VD TTL high impedance, automatic positive/negative polarity compatible [YPbPr signal] Y: 1.0 V [p-p] including synchronization signal, PbPr: 0.7 V [p-p] 75 Ω
	COMPUTER IN 2/ MONITOR OUT	RGB signal] 0.7 V [p-p] 75 Ω (When G-SYNC: 1.0 [p-p] 75 Ω HD/SYNC TTL high impedance, automatic positive/negative polarity compatible VD TTL high impedance, automatic positive/negative polarity compatible
	VIDEO IN	1 (RCA pin jack 1.0 V [p-p] 75 Ω)
	S-VIDEO IN	1 (Mini DIN 4 pin, Y 1.0 V [p-p], C 0.286 V [p-p] 75 Ω, S1 signal compatible)
	HDMI	1 (HDMI 19 pin, HDCP and Deep color compatible)
	AUDIO IN	2 (M3 stereo mini jack, 0.5 V [rms], input impedance 22 kΩ and more) 1 (RCA pin jack x 2 (L-R), 0.5 V [rms], input impedance 22 kΩ and more)
	AUDIO OUT	1 (M3 stereo mini jack, stereo monitor output compatible, 0 V [rms] to 2.0 V [rms] valuable, output impedance 2.2 kΩ and less)
	CONTROL PORT	1 (D-sub 9 pin, RS-232C compliant, for computer control use)
	LAN	1 (for RJ-45 network connection, PLink compatible,)
Power cable length		2.0 m (78.74")
Cabinet		Molded plastic
Dimensions		Width: 350 mm (13.78") Height: 87.5 mm (3.45") {97.0 mm (3.82") when front adjustable feet shortened} Depth: 254.4 mm (10.02") (excluding protractions)
Weight		Approx.3.4 kg (7.50 lbs.) *3
Operating environment		Operating environment temperature : 5 °C (41 °F) to 35 °C (95 °F) Operating environment humidity: 20 % to 80 % (no condensation)
Remote control	Power supply	DC 3 V (battery (AAA/R03 or AAA/LR03 Type ) x 2)
	Operating range	Approx. 5 m (196.9") (when operated directly in front of receptor)
	Weight	67 g (2.36 ozs.) (including batteries)
	Dimensions	Width : 52 mm (2.05"), Length : 110 mm (4.33"), Height : 18.2 mm (0.72")

\*3 : This is an average value. It may differ depending on individual product.

- The part numbers of accessories and separately sold components are subject to change without notice.

## Dimensions

<Unit : mm(inch)>

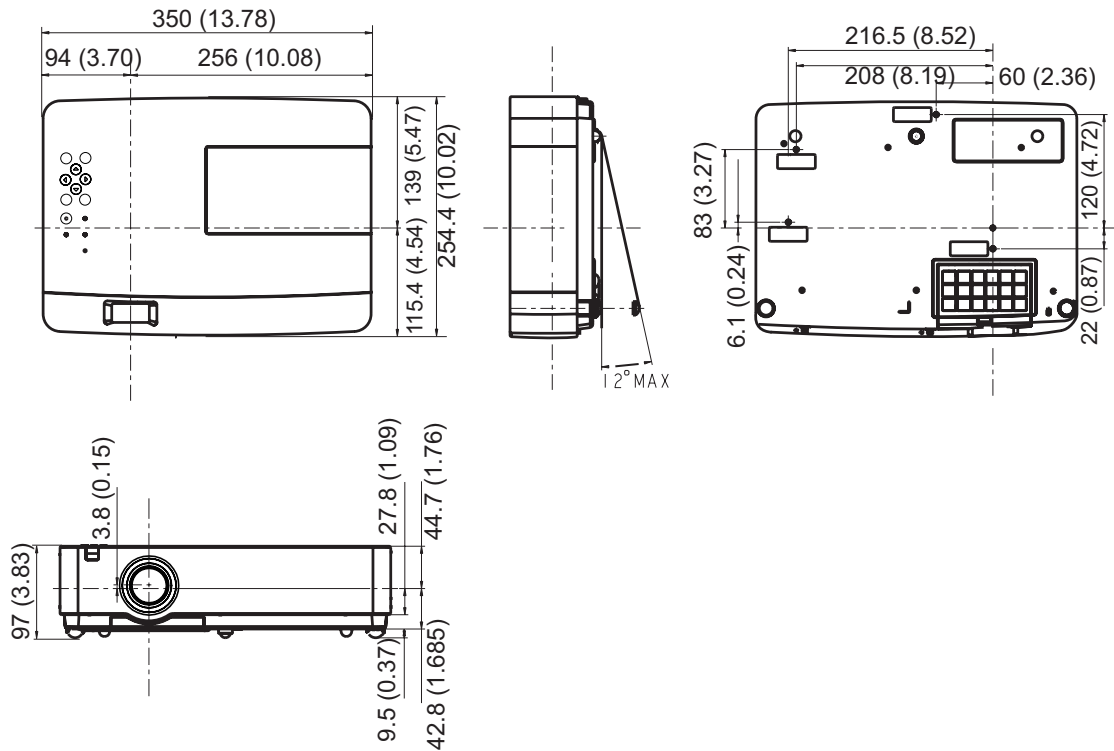

\*: Actual dimension may differ by product.

## Ceiling mount bracket safeguards

- Installation work of the ceiling mount bracket should only be carried by a qualified technician.
- Even if it is during guaranteed period, the manufacturer is not responsible for any hazard or damage caused by using a ceiling mount bracket which is not purchased from an authorized distributors, or environmental conditions.
- Remove an unused ceiling mount bracket promptly.
- Ensure to use a torque driver and do not use an electrical screwdriver or an impact screwdriver.
- For details, see the work instruction manual packed together with the ceiling mount bracket.
- The model Nos. of the accessories and the parts sold separately are subject to change without notice.
- Make sure the screws on the ceiling mount kit cannot touch the metal parts materials (metallic lath, wire or board) in the ceiling board. Otherwise it may result in fire hazard.

Bottom view

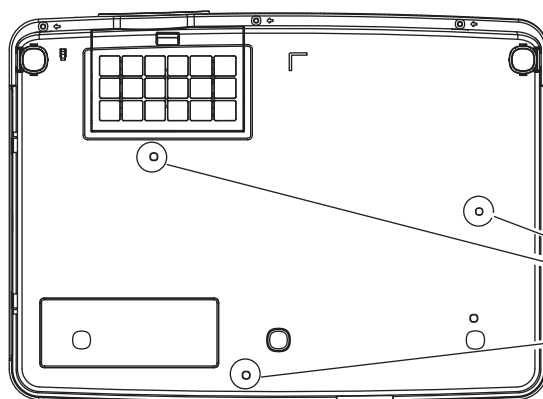

Model No. of ceiling mount bracket:  
 ET-PKV100H (for high ceilings)  
 ET-PKV100S (for low ceilings)  
 Model No. of projector mount base:  
 ET-PKV100B

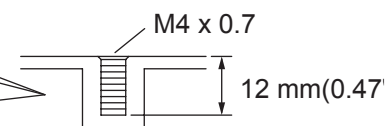

Torque:  $1.2 \pm 0.1 \text{ N} \cdot \text{m}$



# Index

<b>A</b>			
About Your Projector.....	15	Input search.....	49
Accessories.....	13	Installing and Removing batteries ..	18
Adjusting front adjustable feet .....	21	<b>K</b>	
Attaching the Lens Cap.....	76	Keystone.....	30, 46
Auto PC adjust.....	38	<b>L</b>	
Auto setup.....	49	Lamp power.....	53
AV MUTE.....	31	LAMP REPLACE indicator .....	71
<b>B</b>		Lamp unit.....	74
Background.....	50	Language.....	49
Basic operations by using the remote control.....	29	List of compatible signals .....	86
Blackboard(Green).....	41	Logo.....	50
Brightness.....	42	<b>M</b>	
<b>C</b>		Main menu.....	34
Cautions on use.....	12	Maintenance.....	72
Cautions when installing.....	10	Managing the indicated problems.....	71
Cautions when transporting.....	10	Manual PC adjust.....	39
CD-ROM.....	14	Menu Navigation.....	33
Ceiling.....	47	Menu position .....	49
Cinema.....	41	MIC.....	48
Closed caption.....	53	Mute.....	48
Color.....	42	<b>N</b>	
Colorboard.....	41	Network.....	57
Color temp.....	42	Network connections .....	59
Computer System Selection.....	36	Noise reduction.....	43
Connecting.....	22	Normal.....	45
Connecting the power cord.....	23	<b>O</b>	
Contrast.....	42	Optional accessories .....	14
Control panel.....	17	Other terminals.....	85
Custom.....	45	<b>P</b>	
Custom adj. ....	46	PIN code.....	26
<b>D</b>		POWER indicator .....	24
Digital zoom.....	46	Power management .....	51
Direct on .....	52	Precautions for Use.....	10
Direct Power Off function.....	27	Progressive.....	44
Display.....	50	Projecting.....	28
Disposal.....	11	Projection distance .....	20
Dynamic.....	41	Projection method.....	19
<b>F</b>		Projector body .....	16
Factory default.....	55	P-timer.....	52
Fan.....	54	<b>R</b>	
Fan control.....	54	Read this first!.....	2
Filter counter.....	55	Real.....	41
FREEZE .....	30	Rear.....	47
Full.....	45	Rear terminals .....	17
<b>G</b>		Remote control .....	15
Gamma.....	43	Replacing the Lamp unit.....	75
<b>H</b>		Replacing the unit.....	72
HDMI setup.....	51	<b>S</b>	
How to adjust the state of the image .. 28		Screen.....	45
<b>I</b>		Screen size and throw distance.....	20
ID numbers.....	18	Security.....	11
Image adjust.....	42	Selecting the image.....	28
Image select .....	41	Serial terminal.....	82
Information.....	56	Setting .....	49
Input menu.....	36	Setting the ID number.....	18
		Setting up .....	19
		Sharpness .....	43
		Sound.....	48
		Specifications .....	90
		Standard.....	41
		Standby mode .....	52
		Sub menu .....	34
		Switching the input signal.....	29
		<b>T</b>	
		Terminal.....	51
		Tint.....	42
		Total power savings.....	55
		Troubleshooting.....	77
		True .....	45
		Turning Off the Projector .....	27
		Turning On the Projector .....	25
		<b>V</b>	
		Video delay control.....	55
		Video System Selection.....	36
		Volume.....	48
		<b>W</b>	
		WARNING indicator.....	71
		Warning log .....	55
		Wide(16:9).....	45
		<b>Z</b>	
		Zoom .....	45

## Information for Users on Collection and Disposal of Old Equipment and used Batteries



These symbols on the products, packaging, and/or accompanying documents mean that used electrical and electronic products and batteries should not be mixed with general household waste. For proper treatment, recovery and recycling of old products and used batteries, please take them to applicable collection points, in accordance with your national legislation and the Directives 2002/96/EC and 2006/66/EC.

By disposing of these products and batteries correctly, you will help to save valuable resources and prevent any potential negative effects on human health and the environment which could otherwise arise from inappropriate waste handling.



For more information about collection and recycling of old products and batteries, please contact your local municipality, your waste disposal service or the point of sale where you purchased the items.

Penalties may be applicable for incorrect disposal of this waste, in accordance with national legislation.



### **For business users in the European Union**

If you wish to discard electrical and electronic equipment, please contact your dealer or supplier for further information.

### **Information on Disposal in other Countries outside the European Union**

These symbols are only valid in the European Union. If you wish to discard these items, please contact your local authorities or dealer and ask for the correct method of disposal.

### **Note for the battery symbol (bottom two symbol examples):**

This symbol might be used in combination with a chemical symbol. In this case it complies with the requirement set by the Directive for the chemical involved.

# Panasonic Corporation

Web Site : <http://panasonic.net/avc/projector/>