

# Panasonic®

Model No.

**TH-85VX200W**  
**TH-103VX200W**

## Operating Instructions High Definition Plasma Display



**3D**  
FULL HD

**HDMI**

**English**

Please read these instructions before operating your set and retain them for future reference.

## ***Dear Panasonic Customer***

*Welcome to the Panasonic family of customers. We hope that you will have many years of enjoyment from your new Plasma Display.*

*To obtain maximum benefit from your set, please read these Instructions before making any adjustments, and retain them for future reference.*

*Retain your purchase receipt also, and note down the model number and serial number of your set in the space provided on the rear cover of these instructions.*

*Visit our Panasonic Web Site      <http://panasonic.net>*



The lightning flash with arrow-head within a triangle is intended to tell the user that parts inside the product are a risk of electric shock to persons.



The exclamation point within a triangle is intended to tell the user that important operating and servicing instructions are in the papers with the appliance.

**WARNING :** To prevent damage which may result in fire or shock hazard, do not expose this apparatus to rain or moisture.  
Do not place containers with water (flower vase, cups, cosmetics, etc.) above the set. (including on shelves above, etc.)

**WARNING :** 1) To prevent electric shock, do not remove cover. No user serviceable parts inside. Refer servicing to qualified service personnel.  
2) Do not remove the grounding pin on the power plug. This apparatus is equipped with a three pin grounding-type power plug. This plug will only fit a grounding-type power outlet. This is a safety feature. If you are unable to insert the plug into the outlet, contact an electrician.  
Do not defeat the purpose of the grounding plug.

## Important Safety Instructions

- 1) Read these instructions.
- 2) Keep these instructions.
- 3) Heed all warnings.
- 4) Follow all instructions.
- 5) Do not use this apparatus near water.
- 6) Clean only with dry cloth.
- 7) Do not block any ventilation openings. Install in accordance with the manufacturer's instructions.
- 8) Do not install near any heat sources such as radiators, heat registers, stoves, or other apparatus (including amplifiers) that produce heat.
- 9) Do not defeat the safety purpose of the polarized or grounding-type plug. A polarized plug has two blades with one wider than the other. A grounding type plug has two blades and a third grounding prong. The wide blade or the third prong are provided for your safety. If the provided plug does not fit into your outlet, consult an electrician for replacement of the obsolete outlet.
- 10) Protect the power cord from being walked on or pinched particularly at plugs, convenience receptacles, and the point where they exit from the apparatus.
- 11) Only use attachments / accessories specified by the manufacturer.
- 12) Use only with the cart, stand, tripod, bracket, or table specified by the manufacturer, or sold with the apparatus. When a cart is used, use caution when moving the cart / apparatus combination to avoid injury from tip-over.
- 13) Unplug this apparatus during lightning storms or when unused for long periods of time.
- 14) Refer all servicing to qualified service personnel. Servicing is required when the apparatus has been damaged in any way, such as power-supply cord or plug is damaged, liquid has been spilled or objects have fallen into the apparatus, the apparatus has been exposed to rain or moisture, does not operate normally, or has been dropped.
- 15) To prevent electric shock, ensure the grounding pin on the AC cord power plug is securely connected.



# Important Safety Notice

## WARNING

- 1) To prevent damage which may result in fire or shock hazard, do not expose this appliance to dripping or splashing.  
Do not place containers with water (flower vase, cups, cosmetics, etc.) above the set. (including on shelves above, etc.)  
No naked flame sources, such as lighted candles, should be placed on / above the set.
- 2) To prevent electric shock, do not remove cover. No user serviceable parts inside. Refer servicing to qualified service personnel.
- 3) Do not remove the earthing pin on the power plug. This apparatus is equipped with a three pin earthing-type power plug. This plug will only fit an earthing-type power outlet. This is a safety feature. If you are unable to insert the plug into the outlet, contact an electrician.  
Do not defeat the purpose of the earthing plug.
- 4) To prevent electric shock, ensure the earthing pin on the AC cord power plug is securely connected.

## CAUTION

This appliance is intended for use in environments which are relatively free of electromagnetic fields. Using this appliance near sources of strong electromagnetic fields or where electrical noise may overlap with the input signals could cause the picture and sound to wobble or cause interference such as noise to appear. To avoid the possibility of harm to this appliance, keep it away from sources of strong electromagnetic fields.

## IMPORTANT INFORMATION

If a display is not positioned in a sufficiently stable location, it can be potentially hazardous due to falling. Many injuries, particularly to children, can be avoided by taking simple precautions such as:

- Using cabinets or stands recommended by the manufacturer of the display.
- Only using furniture that can safely support the display.
- Ensuring the display is not overhanging the edge of the supporting furniture.
- Not placing the display on tall furniture (for example, cupboards or bookcases) without anchoring both the furniture and the display to a suitable support.
- Not standing the displays on cloth or other materials placed between the display and supporting furniture.
- Educating children about the dangers of climbing on furniture to reach the display or its controls.

## IMPORTANT: THE MOULDED PLUG

FOR YOUR SAFETY, PLEASE READ THE FOLLOWING TEXT CAREFULLY.

This display is supplied with a moulded three pin mains plug for your safety and convenience. A 10 amp fuse is fitted in this plug. Shall the fuse need to be replaced, please ensure that the replacement fuse has a rating of 10 amps and that it is approved by ASTA or BSI to BS1362.

Check for the ASTA mark  or the BSI mark  on the body of the fuse.

If the plug contains a removable fuse cover, you must ensure that it is refitted when the fuse is replaced.

If you lose the fuse cover the plug must not be used until a replacement cover is obtained.

A replacement fuse cover can be purchased from your local Panasonic dealer.

Do not cut off the mains plug.

Do not use any other type of mains lead except the one supplied with this display.

The supplied mains lead and moulded plug are designed to be used with this display to avoid interference and for your safety.

If the socket outlet in your home is not suitable, get it changed by a qualified electrician.

If the plug or mains lead becomes damaged, purchase a replacement from an authorized dealer.

### **WARNING : — THIS DISPLAY MUST BE EARTHED.**

How to replace the fuse. Open the fuse compartment with a screwdriver and replace the fuse.

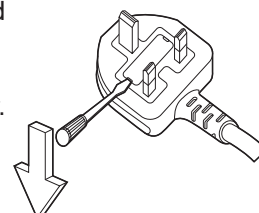

# Table of Contents

<b>Important Safety Instructions</b> .....	iii	<b>Setup menu</b> .....	41
<b>Important Safety Notice</b> .....	iv	Component / RGB-in select.....	41
<b>Safety Precautions</b> .....	2	YUV / RGB-in select.....	41
3D Safety Precautions.....	5	External scaler mode.....	42
<b>Accessories</b> .....	7	Power save.....	43
Accessories Supply .....	7	PC Power management: .....	43
Remote Control Batteries .....	7	Auto power off .....	43
<b>Connections</b> .....	8	OSD design .....	43
AC cord connection and fixing, cable fixing.....	8	OSD position .....	43
Video equipment connection .....	10	OSD Language.....	43
AUDIO OUT connection .....	10	3D Settings.....	44
HDMI connection.....	11	Signal menu .....	45
COMPONENT / RGB IN connection .....	11	Screensaver .....	47
PC Input Terminals connection.....	12	Extended life settings .....	48
SERIAL Terminals connection .....	13	Customizing the Input labels .....	51
<b>Power On / Off</b> .....	14	Network Setup.....	52
<b>Selecting the input signal</b> .....	16	<b>Options Adjustments</b> .....	53
<b>Basic Controls</b> .....	17	3D Safety Precautions (To hide 3D Safety	
<b>ASPECT Controls</b> .....	19	Precautions) .....	54
<b>Viewing 3D images</b> .....	20	<b>Using FUNCTION button</b> .....	54
3D Eyewear.....	20	<b>Using Network Function</b> .....	55
To view the 3D images .....	22	Example of Network Connection .....	55
Troubleshooting for 3D Eyewear .....	23	Command Control .....	55
Table of images that can be seen for each 3D		PLink™ Protocol.....	56
Picture Format and the source image format .....	23	<b>Using Web Browser Control</b> .....	57
<b>On-Screen Menu Displays</b> .....	24	Before Using Web Browser Control.....	57
<b>Adjusting Pos. /Size</b> .....	25	Access from Web Browser .....	57
<b>Picture Adjustments</b> .....	28	Display Control (BASIC CONTROL/OPTION	
Advanced settings .....	30	CONTROL Screen) .....	58
Colour space adjustment (Colour Gamut).....	32	NETWORK SETTING (Network Setup Screen) ...	59
<b>Picture Profiles</b> .....	34	Password Setting (Password Setup Screen) .....	59
Saving profiles .....	35	<b>Troubleshooting</b> .....	60
Loading profiles .....	36	<b>List of Aspect Modes</b> .....	61
Editing profiles.....	37	<b>Applicable Input Signals</b> .....	62
Locking profiles .....	38	<b>Shipping condition</b> .....	63
<b>Sound Adjustment</b> .....	40	<b>Specifications</b> .....	64
SDI Sound Output .....	40		

## Trademark Credits

- VGA is a trademark of International Business Machines Corporation.
- Macintosh is a registered trademark of Apple Inc., USA.
- SVGA, XGA, SXGA and UXGA are registered trademarks of the Video Electronics Standard Association.  
Even if no special notation has been made of company or product trademarks, these trademarks have been fully respected.
- HDMI, the HDMI Logo, and High-Definition Multimedia Interface are trademarks or registered trademarks of HDMI Licensing LLC in the United States and other countries.

## Note:

Do not allow a still picture to be displayed for an extended period, as this can cause a permanent image retention to remain on the Plasma Display.

Examples of still pictures include logos, video games, computer images, teletext and images displayed in 4:3 mode.

# Safety Precautions

## WARNING

### ■ Setup

**This Plasma Display is for use only with the following optional accessories. Use with any other type of optional accessories may cause instability which could result in the possibility of injury.**

(All of the following accessories are manufactured by Panasonic Corporation.)

- Pedestal ..... TY-ST85P12 (for TH-85VX200W)  
TY-ST103PF9 (for TH-103VX200W)
- Floor stand ..... TY-ST85PF12 (for TH-85VX200W)
- Wall-hanging bracket (vertical) ..... TY-WK85PV12 (for TH-85VX200W)  
TY-WK103PV9 (for TH-103VX200W)
- BNC Dual Video Terminal Board ..... TY-FB9BD
- HD-SDI Terminal Board with audio ..... TY-FB10HD
- Dual Link HD-SDI Terminal Board ..... TY-FB11DHD
- Ir Through Terminal Board ..... TY-FB9RT
- DVI-D Terminal Board ..... TY-FB11DD
- AV Terminal Box ..... TY-TB10AV

Always be sure to ask a qualified technician to carry out set-up.

Small parts can present choking hazard if accidentally swallowed. Keep small parts away from young children. Discard unneeded small parts and other objects, including packaging materials and plastic bags/sheets to prevent them from being played with by young children, creating the potential risk of suffocation.

**Do not place the Plasma Display on sloped or unstable surfaces.**

- The Plasma Display may fall off or tip over.

**Do not place any objects on top of the Plasma Display.**

- If water is spilled onto the Plasma Display or foreign objects get inside it, a short-circuit may occur which could result in fire or electric shock. If any foreign objects get inside the Plasma Display, please consult your local Panasonic dealer.

**Transport only in upright position!**

- Transporting the unit with its display panel facing upright or downward may cause damage to the internal circuitry.

**Ventilation should not be impeded by covering the ventilation openings with items such as newspapers, table cloths and curtains.**

**For sufficient ventilation;**

**(TH-85VX200W)**

If using the pedestal (optional accessory), leave a space of 10 cm or more at the top, left and right, and 15 cm or more at the rear, and also keep the space between the bottom of the display and the floor surface.

If using some other setting-up method, follow the manual of it. (If there is no specific indication of installation dimension in the installation manual, leave a space of 10 cm or more at the top, bottom, left and right, and 15 cm or more at the rear.)

**(TH-103VX200W)**

If using the pedestal (optional accessory), leave a space of 30 cm or more at the top, left and right, and 20 cm or more at the rear, and also keep the space between the bottom of the display and the floor surface.

If using some other setting-up method, follow the manual of it. (If there is no specific indication of installation dimension in the installation manual, leave a space of 30 cm or more at the top, bottom, left and right, and 20 cm or more at the rear.)

## ■ When using the Plasma Display

The Plasma Display is designed to operate on 200 - 240 V AC, 50/60 Hz.

**Do not cover the ventilation holes.**

- Doing so may cause the Plasma Display to overheat, which can cause fire or damage to the Plasma Display.

**Do not stick any foreign objects into the Plasma Display.**

- Do not insert any metal or flammable objects into the ventilations holes or drop them onto the Plasma Display, as doing so can cause fire or electric shock.

**Do not remove the cover or modify it in any way.**

- High voltages which can cause severe electric shocks are present inside the Plasma Display. For any inspection, adjustment and repair work, please contact your local Panasonic dealer.

**Ensure that the mains plug is easily accessible.**

An apparatus with CLASS I construction shall be connected to a mains socket outlet with a protective earthing connection.

**Do not use any power supply cord other than that provided with this unit.**

- Doing so may cause fire or electric shocks.

**Securely insert the power supply plug as far as it will go.**

- If the plug is not fully inserted, heat may be generated which could cause fire. If the plug is damaged or the wall socket is loose, they shall not be used.

**Do not handle the power supply plug with wet hands.**

- Doing so may cause electric shocks.

**Do not do anything that may damage the power cable. When disconnecting the power cable, pull on the plug body, not the cable.**

- Do not damage the cable, make any modifications to it, place heavy objects on top of it, heat it, place it near any hot objects, twist it, bend it excessively or pull it. To do so may cause fire and electric shock. If the power cable is damaged, have it repaired at your local Panasonic dealer.

**If the Plasma Display is not going to be used for any prolonged length of time, unplug the power supply plug from the wall outlet.**

**To prevent the spread of fire, keep candles or other open flames away from this product at all times.**



## ■ If problems occur during use

**If a problem occurs (such as no picture or no sound), or if smoke or an abnormal odour starts to come out from the Plasma Display, immediately unplug the power supply plug from the wall outlet.**

- If you continue to use the Plasma Display in this condition, fire or electric shock could result. After checking that the smoke has stopped, contact your local Panasonic dealer so that the necessary repairs can be made. Repairing the Plasma Display yourself is extremely dangerous, and shall never be done.

**If water or foreign objects get inside the Plasma Display, if the Plasma Display is dropped, or if the cabinet becomes damages, disconnect the power supply plug immediately.**

- A short circuit may occur, which could cause fire. Contact your local Panasonic dealer for any repairs that need to be made.

## Safety Precautions

---



### CAUTION

#### ■ When using the Plasma Display

**Do not bring your hands, face or objects close to the ventilation holes of the Plasma Display.**

- Heated air comes out from the ventilation holes at the top of Plasma Display will be hot. Do not bring your hands or face, or objects which cannot withstand heat, close to this port, otherwise burns or deformation could result.

**Be sure to disconnect all cables before moving the Plasma Display.**

- If the Plasma Display is moved while some of the cables are still connected, the cables may become damaged, and fire or electric shock could result.

**Disconnect the power supply plug from the wall socket as a safety precaution before carrying out any cleaning.**

- Electric shocks can result if this is not done.

**Clean the power cable regularly to prevent it becoming dusty.**

- If dust built up on the power cord plug, the resultant humidity can damage the insulation, which could result in fire. Pull the power cord plug out from the wall outlet and wipe the mains lead with a dry cloth.

**Do not burn or breakup batteries.**

- Batteries must not be exposed to excessive heat such as sunshine, fire or the like.

**This Plasma Display radiates infrared rays, therefore it may affect other infrared communication equipment. Install your infrared sensor in a place away from direct or reflected light from your Plasma Display.**

## Cleaning and maintenance

**The front of the display panel has been specially treated. Wipe the panel surface gently using only a cleaning cloth or a soft, lint-free cloth.**

- If the surface is particularly dirty, wipe with a soft, lint-free cloth which has been soaked in pure water or water in which neutral detergent has been diluted 100 times, and then wipe it evenly with a dry cloth of the same type until the surface is dry.
- Do not scratch or hit the surface of the panel with fingernails or other hard objects, otherwise the surface may become damaged. Furthermore, avoid contact with volatile substances such as insect sprays, solvents and thinner, otherwise the quality of the surface may be adversely affected.

**If the cabinet becomes dirty, wipe it with a soft, dry cloth.**

- If the cabinet is particularly dirty, soak the cloth in water to which a small amount of neutral detergent has been added and then wring the cloth dry. Use this cloth to wipe the cabinet, and then wipe it dry with a dry cloth.
- Do not allow any detergent to come into direct contact with the surface of the Plasma Display. If water droplets get inside the unit, operating problems may result.
- Avoid contact with volatile substances such as insect sprays, solvents and thinner, otherwise the quality of the cabinet surface may be adversely affected or the coating may peel off. Furthermore, do not leave it for long periods in contact with articles made from rubber or PVC.



# 3D Safety Precautions

---

## WARNING

### ■ Small Parts

3D Eyewear contains small parts (battery and specialised band, etc.) and must be kept out of reach of small children to avoid accidental ingestion.

### ■ Disassembly

Do not disassemble or modify the 3D Eyewear.

### ■ Lithium Battery

Batteries must not be exposed to excessive heat such as sunshine, fire or the like.



## CAUTION

To enjoy 3D images safely and comfortably, please read these instructions fully.

### ■ Use for commercial applications and public viewing

Someone in authority should responsibly convey the precautions for use of the 3D Eyewear to the user.

### ■ 3D Eyewear

Do not drop, exert pressure on, or step on the 3D Eyewear.

Always store the 3D Eyewear in the case provided when not in use.

Be careful of the tips of the frame when putting on the 3D Eyewear.

Be careful not to trap a finger in the hinge section of the 3D Eyewear.

Pay special attention when children are using the 3D Eyewear.

3D Eyewear should not be used by children younger than 5 - 6 years old, as a guideline.

All children must be fully supervised by parents or guardians who must ensure their safety and health throughout the using 3D Eyewear.

# Safety Precautions

---

## ■ Viewing 3D Content

Content for 3D viewing includes commercially available Blu-ray discs, 3D broadcasts, etc.

When preparing your own 3D content, ensure that it is properly produced.

Do not use the 3D Eyewear if you have a history of over-sensitivity to light, heart problems, or have any other existing medical conditions.

Please stop using the 3D Eyewear immediately, if you feel tired, are not feeling well or experience any other uncomfortable sensation.

Take an appropriate break after viewing a 3D movie.

Take a break of between 30 - 60 minutes after viewing 3D content on interactive devices such as 3D games or computers.

Be careful not to strike the screen or other people unintentionally. When using the 3D Eyewear the distance between the user and screen can be misjudged.

The 3D Eyewear must only be worn when viewing 3D content.

If you do not look toward the screen for a while when viewing 3D images, the 3D Eyewear may be turned off automatically.

If you suffer from any eyesight problems (short / far-sighted, astigmatism, eyesight differences in left and right), please ensure to correct your vision before using the 3D Eyewear.

Stop using the 3D Eyewear if you can clearly see double images when viewing 3D content.

When the multiple plasma displays are placed side by side, 3D images may be seen doubly due to interference among them. Place each display at an appropriate location to avoid it.

Do not use the 3D Eyewear at a distance less than the recommended distance.

View from at least the recommended distance (3 times the effective height of the screen).

TH-85VX200W: 3.2 m or more

TH-103VX200W: 3.9 m or more

When the top and bottom area of the screen is blackened, such as movies, view the screen at a distance 3 times further than the height of the actual image. (That makes the distance closer than above recommended figure.)

## ■ 3D Eyewear Use

Before using the 3D Eyewear, ensure no breakable objects surrounding the user to avoid any accidental damage or injury.

Remove the 3D Eyewear before moving around to avoid falling or accidental injury.

Always put the 3D Eyewear in the case (supplied) after use.

Use the 3D Eyewear only for the intended purpose and nothing else.

Do not use 3D Eyewear in the condition of high temperature.

Do not use if the 3D Eyewear is physically damaged.

Do not use any devices that emit the infrared signals near the 3D Eyewear, as this may cause the 3D Eyewear false operations.

Do not use devices (such as mobile phones or personal transceivers) that emit strong electromagnetic waves near the 3D Eyewear as this may cause the 3D Eyewear to malfunction.

Stop using the 3D Eyewear immediately if a malfunction or fault occurs.

Stop using the 3D Eyewear immediately if you experience any redness, pain, or skin irritation around the nose or temples.

In rare cases, the materials used in the 3D Eyewear may cause an allergic reaction.

## ■ Lithium Battery

Danger of explosion if battery is incorrectly replaced. Replace only with the same or equivalent type.

# Accessories

## Accessories Supply

Check that you have the accessories and items shown



Remote Control Transmitter  
N2QAYB000562



Batteries for the Remote Control Transmitter  
(R6 (UM3) Size × 2)

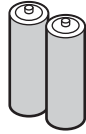

Fixing band × 2  
TMME203

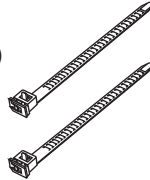

Power supply cord

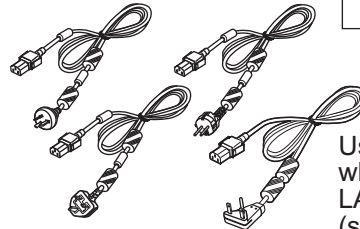

**TH-85VX200W**

Clamper × 1  
TMM15412-2

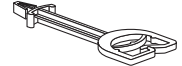

Use the clamper when connecting a LAN cable.  
(see page 55)

3D Eyewear set  
(see page 20)



Screwdriver



For 3D Eyewear  
(see page 21)

Operating Instructions

Ferrite core × 2  
J0KG00000014

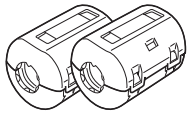

Noise cut filter  
TXZDM011MBE

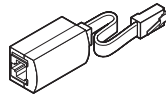

These accessories will be used by professional installers when they install the unit.

**TH-85VX200W**

Eyebolt cap × 1



Eyebolt × 1  
(M12)



Allen wrench



**TH-103VX200W**

Eyebolt cap × 1



Eyebolt × 1  
(M16)



Allen wrench



Use the Ferrite cores and Noise cut filter to comply with the EMC standard. (see page 55)

## Remote Control Batteries

Requires two R6 batteries.

1. Pull and hold the hook, then open the battery cover.
2. Insert batteries - note correct polarity (+ and -).

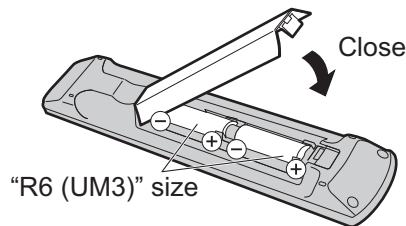
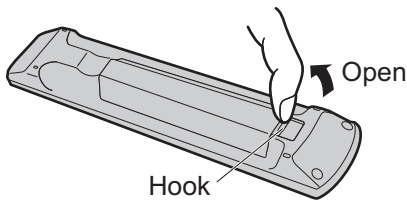

### Helpful Hint:

For frequent remote control users, replace old batteries with Alkaline batteries for longer life.

### ⚠️ Caution on battery use

Incorrect installation can cause battery leakage and corrosion that will damage the remote control transmitter. Disposal of batteries should be in an environment-friendly manner.

**Observe the following precaution:**

1. Batteries shall always be replaced as a pair. Always use new batteries when replacing the old set.
2. Do not combine a used battery with a new one.
3. Do not mix battery types (example: "Zinc Carbon" with "Alkaline").
4. Do not attempt to charge, short-circuit, disassemble, heat or burn used batteries.
5. Battery replacement is necessary when remote control acts sporadically or stops operating the Plasma Display set.
6. Do not burn or breakup batteries.  
Batteries must not be exposed to excessive heat such as sunshine, fire or the like.

# Connections

## AC cord connection and fixing, cable fixing

TH-85VX200W

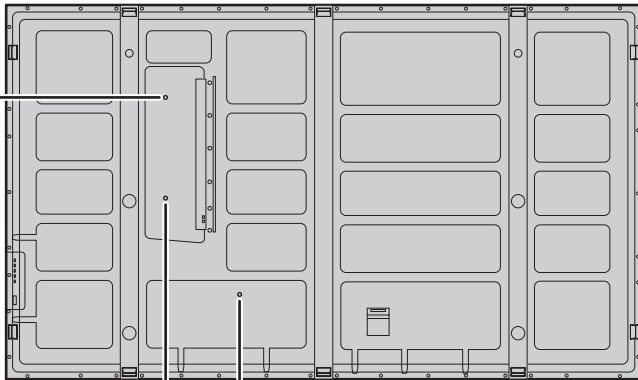

### - AC cord fixing

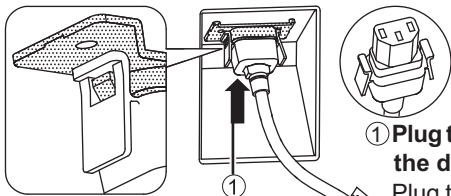

**Note:**  
Make sure that the AC cord is locked on both the left and right sides.

- 1 Plug the AC cord into the display unit.  
Plug the AC cord until it clicks.
- 2 Fix the AC cord with the clamer.

### Close

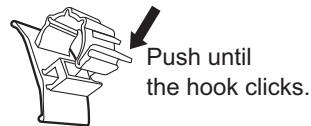

### Open

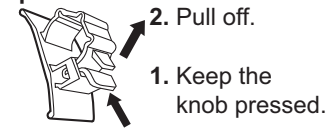

### Unplug the AC cord

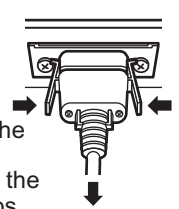

**Note:**  
When disconnecting the AC cord, be absolutely sure to disconnect the AC cord plug at the socket outlet first.

### - Cable fixing bands

Secure any excess cables with bands as required.

#### **Note:**

Two fixing bands are supplied with this unit. In case of securing cables at three positions, please purchase it separately.

Pass the attached cable fixing band through the clip as shown in the figure.

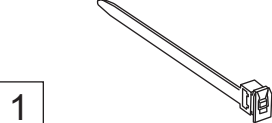

To secure cables connected to Terminals, wrap the cable fixing band around them then pass the pointed end through the locking block, as shown in the figure. **While ensuring there is sufficient slack in cables to minimize stress (especially in the power cord), firmly bind all cables with the supplied fixing band.**

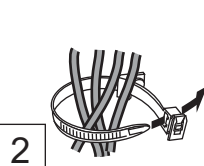

To tighten:

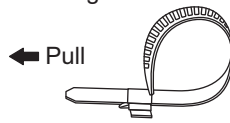

To loosen:

Push the catch

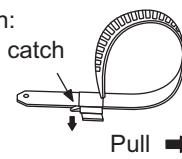

## TH-103VX200W

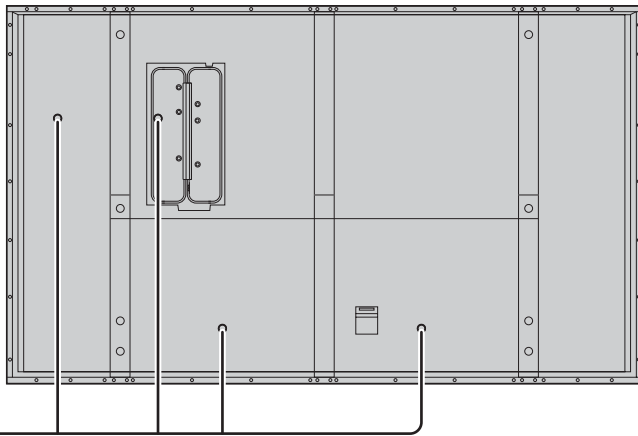

- AC cord fixing

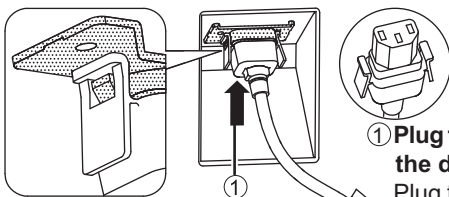

**Note:**  
Make sure that the AC cord is locked on both the left and right sides.

- ① **Plug the AC cord into the display unit.**  
Plug the AC cord until it clicks.
- ② **Fix the AC cord with the clamber.**

**Close**

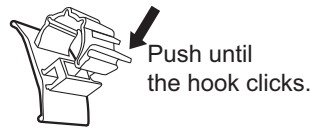

**Open**

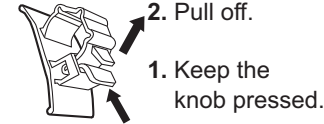

**Unplug the AC cord**

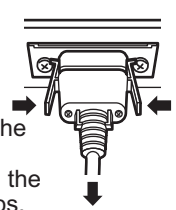

Unplug the AC cord pressing the two knobs.

**Note:**  
When disconnecting the AC cord, be absolutely sure to disconnect the AC cord plug at the socket outlet first.

**- Cable fixing bands**

Secure any excess cables with bands as required.

**Note:**

Two fixing bands are supplied with this unit. In case of securing cables at four positions, please purchase it separately.

Pass the attached cable fixing band through the clip as shown in the figure.



1

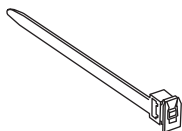

To secure cables connected to Terminals, wrap the cable fixing band around them then pass the pointed end through the locking block, as shown in the figure.

**While ensuring there is sufficient slack in cables to minimize stress (especially in the power cord), firmly bind all cables with the supplied fixing band.**

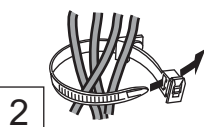

2

To tighten:

← Pull

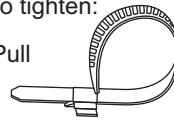

To loosen:

Push the catch

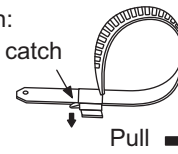

# Video equipment connection

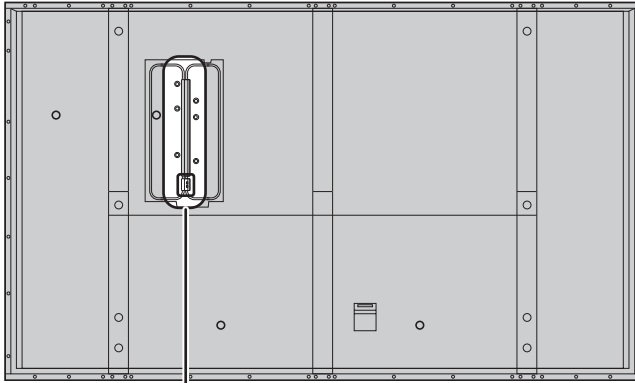

**SERIAL**  
Control the Plasma Display by connecting to PC (see page 13)

**3D SHUTTER OUT**  
Connect the 3D IR TRANSMITTER (optional accessory).

**AUDIO OUT**  
Connect to sound equipment. (see below)

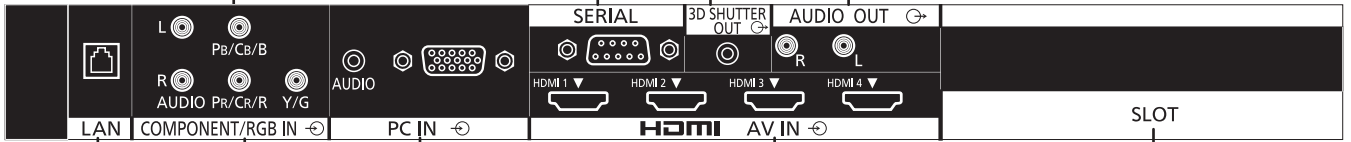

**LAN**  
Connect to a network to control the unit. (see page 55)

**COMPONENT/RGB IN**  
Component/RGB Video Input Terminal (see page 11)

**PC IN**  
PC Input Terminal  
Connect to video terminal of PC or equipment with Y, Pb(Cb) and Pr(Cr) output (see page 12).

**AV IN (HDMI 1-4)**  
HDMI Input Terminal (see page 11)

**SLOT**  
Terminal board (optional accessories) insert slot (see page 2)

# AUDIO OUT connection

**Note:**  
Additional equipment and cables shown are not supplied with this set.

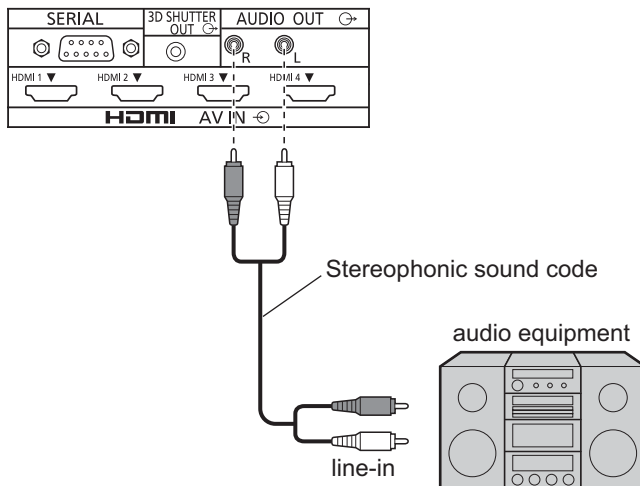

# HDMI connection

[Pin assignments and signal names]

Pin No.	Signal name	Pin No.	Signal name
①	T.M.D.S Data2+	⑪	T.M.D.S Clock Shield
②	T.M.D.S Data2 Shield	⑫	T.M.D.S Clock-
③	T.M.D.S Data2-	⑬	CEC
④	T.M.D.S Data1+	⑭	Reserved (N.C. on device)
⑤	T.M.D.S Data1 Shield		
⑥	T.M.D.S Data1-	⑮	SCL
⑦	T.M.D.S Data0+	⑯	SDA
⑧	T.M.D.S Data0 Shield	⑰	DDC/CEC Ground
⑨	T.M.D.S Data0-	⑱	+5V Power
⑩	T.M.D.S Clock+		Hot Plug Detect

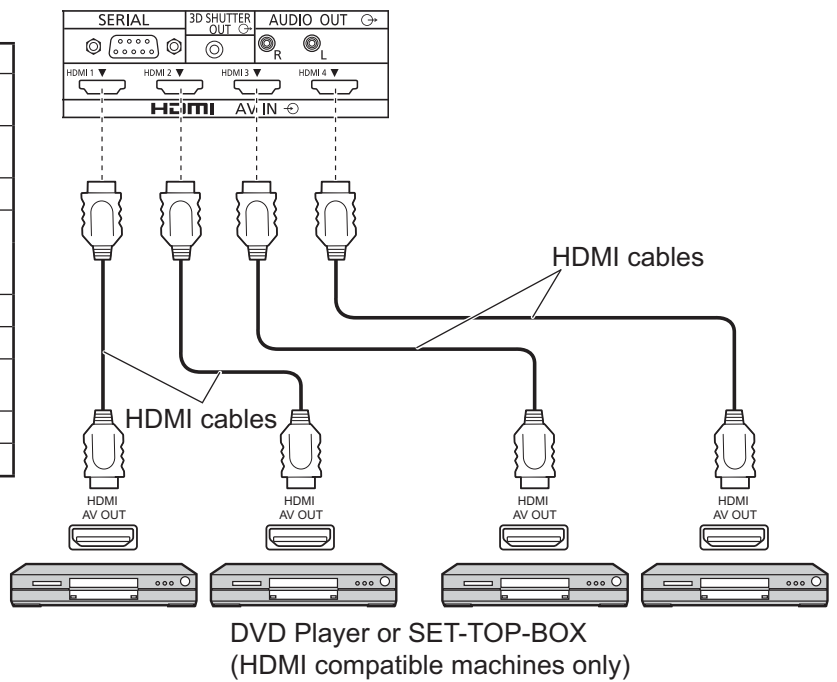
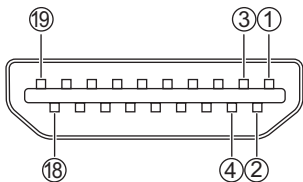

**Note:**

Additional equipment and HDMI cable shown are not supplied with this set.

# COMPONENT / RGB IN connection

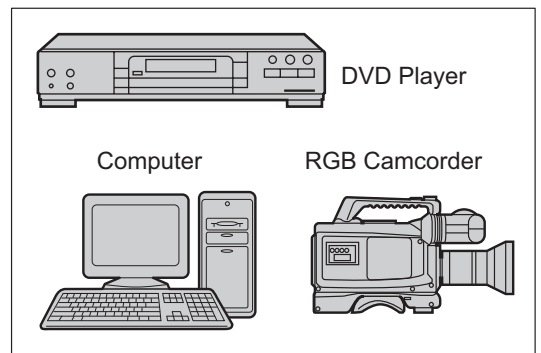
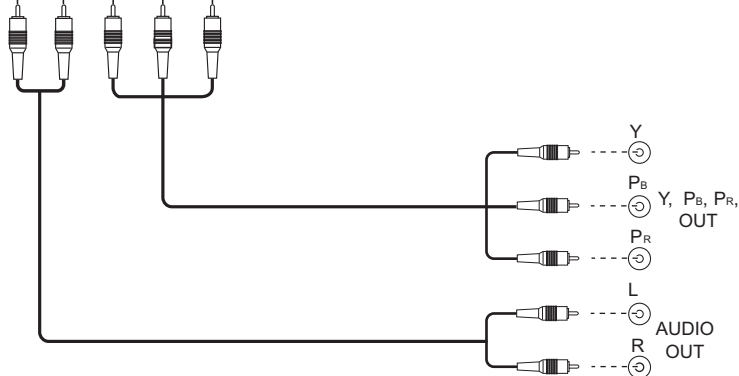
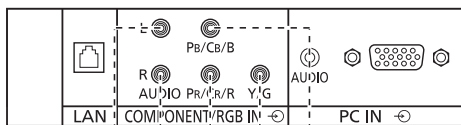

**Notes:**

- Additional equipment and cables shown are not supplied with this set.
- Change the "Component/RGB-in select" setting in the "Setup" menu to "Component" (when Component signal connection) or "RGB" (when RGB signal connection). (see page 41)
- Accepts only RGB signals with "Sync on G".

## PC Input Terminals connection

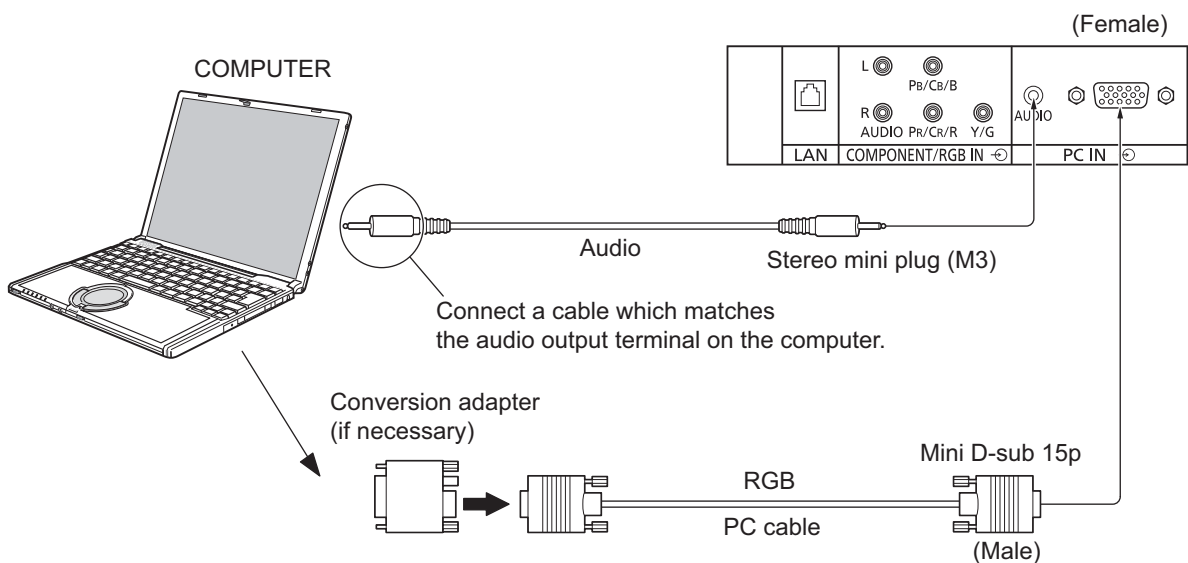

### Notes:

- With regard to the typical PC input signals that are described in the applicable input signals list (see page 62), adjustment values such as for the standard picture positions and sizes have already been stored in this unit. You can add up to eight PC input signal types that are not included in the list.
- Computer signals which can be input are those with a horizontal scanning frequency of 15 to 110 kHz and vertical scanning frequency of 48 to 120 Hz. (However, the image will not be displayed properly if the signals exceed 1,200 lines.)
- The display resolution is a maximum of 1,440 × 1,080 dots when the aspect mode is set to “4:3”, and 1,920 × 1,080 dots when the aspect mode is set to “16:9”. If the display resolution exceeds these maximums, it may not be possible to show fine detail with sufficient clarity.
- The PC input terminals are DDC2B-compatible. If the computer being connected is not DDC2B-compatible, you will need to make setting changes to the computer at the time of connection.
- Some PC models cannot be connected to the set.
- There is no need to use an adapter for computers with DOS/V compatible Mini D-sub 15P terminal.
- The computer shown in the illustration is for example purposes only.
- Additional equipment and cables shown are not supplied with this set.
- Do not set the horizontal and vertical scanning frequencies for PC signals which are above or below the specified frequency range.
- Component Input is possible with the pin 1, 2, 3 of the Mini D-sub 15P Connector.
- To use sync input VBS signals, use the connector which incorporates a 75-ohm termination resistance and which is available on the market, for the connection of the HD connector where the VBS signals are to be input.
- Change the “Component/RGB-in select” setting in the “Setup” menu to “Component” (when Component signal connection) or “RGB” (when RGB signal connection). (see page 41)

### Signal Names for Mini D-sub 15P Connector

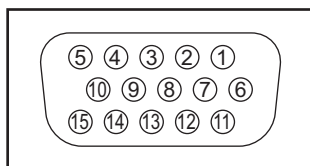

Pin Layout for PC Input Terminal

Pin No.	Signal Name	Pin No.	Signal Name	Pin No.	Signal Name
①	R (Pr/Cr)	⑥	GND (Ground)	⑪	NC (not connected)
②	G (Y)	⑦	GND (Ground)	⑫	SDA
③	B (Pb/Cb)	⑧	GND (Ground)	⑬	HD/SYNC
④	NC (not connected)	⑨	+5 V DC	⑭	VD
⑤	GND (Ground)	⑩	GND (Ground)	⑮	SCL



# SERIAL Terminals connection

The SERIAL terminal is used when the Plasma Display is controlled by a computer.

**Note:** To use serial control for this unit, make sure to set the "Control I/F Select" in the "Network Setup" menu to "RS-232C". (see page 52)

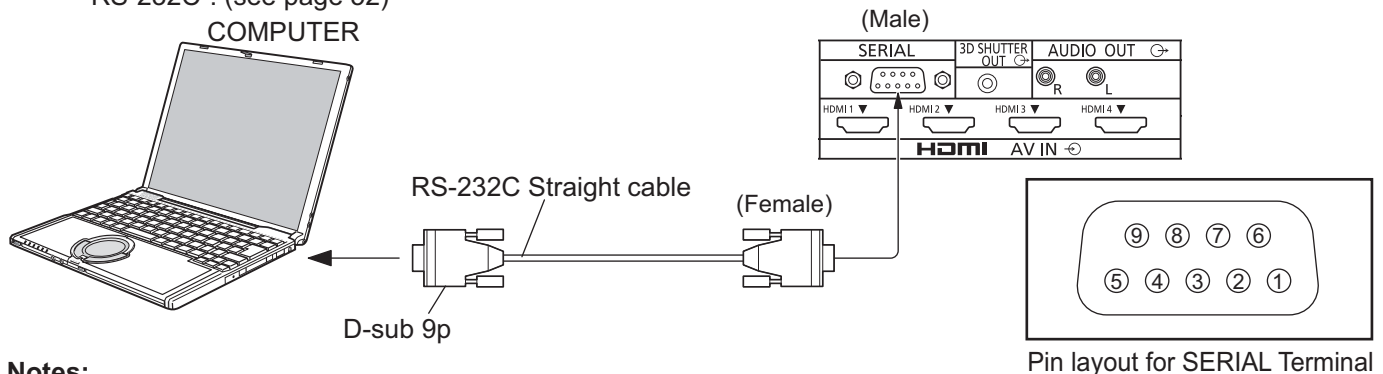

**Notes:**

- Use the RS-232C straight cable to connect the computer to the Plasma Display.
- The computer shown is for example purposes only.
- Additional equipment and cables shown are not supplied with this set.

The SERIAL terminal conforms to the RS-232C interface specification, so that the Plasma Display can be controlled by a computer which is connected to this terminal. The computer will require software which allows the sending and receiving of control data which satisfies the conditions given below. Use a computer application such as programming language software. Refer to the documentation for the computer application for details.

**Communication parameters**

Signal level	RS-232C compliant
Synchronization method	Asynchronous
Baud rate	9600 bps
Parity	None
Character length	8 bits
Stop bit	1 bit
Flow control	-

**Basic format for control data**

The transmission of control data from the computer starts with a STX signal, followed by the command, the parameters, and lastly an ETX signal in that order. If there are no parameters, then the parameter signal does not need to be sent.

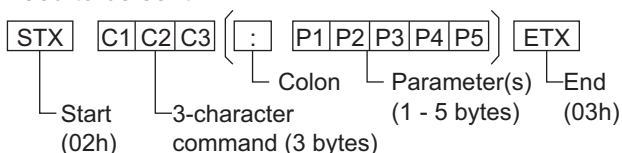

**Notes:**

- If multiple commands are transmitted, be sure to wait for the response for the first command to come from this unit before sending the next command.
- If an incorrect command is sent by mistake, this unit will send an "ER401" command back to the computer.
- S1A and S1B of Command IMS are available only when a dual input terminal board is attached.

**Signal names for D-sub 9P connector**

Pin No.	Details
②	R X D
③	T X D
⑤	GND
④ • ⑥	Non use
⑦ ⑧	(Shorted in this set)
① • ⑨	NC

These signal names are those of computer specifications.

**Command**

Command	Parameter	Control details
PON	None	Power ON
POF	None	Power OFF
AVL	**	Volume 00 - 63
AMT	0	Audio MUTE OFF
	1	Audio MUTE ON
IMS	None	Input select (toggle)
	SL1	SLOT input (SLOT INPUT)
	S1A	SLOT input (SLOT INPUT A)
	S1B	SLOT input (SLOT INPUT B)
	YP1	COMPONENT/RGB IN input (COMPONENT)
	HM1	HDMI 1 input (HDMI1)
	HM2	HDMI 2 input (HDMI2)
	HM4	HDMI 4 input (HDMI4)
DAM	None	Screen mode select (toggle)
	ZOOM	Zoom1 (For Video/SD/PC signal)
	FULL	16:9
	JUST	Just (For Video/SD signal)
	NORM	4:3 (For Video/SD/PC signal)
	ZOM2	Zoom2 (For HD signal)
	ZOM3	Zoom3 (For HD signal)
	SJST	Just (For HD signal)
	SNOM	4:3 (For HD signal)
	SFUL	4:3 Full (For HD signal)
14:9	14:9	

With the power off, this display responds to PON command only.

# Power On / Off

## Connecting the AC cord plug to the Plasma Display.

Fix the AC cord plug securely to the Plasma Display with the clamper. (see page 8, 9)

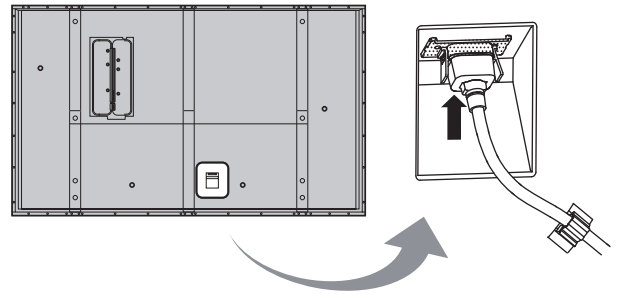

## Connecting the plug to the Wall Outlet

### Notes:

- Main plug types vary between countries. The power plug shown at right may, therefore, not be the type fitted to your set.
- When disconnecting the AC cord, be absolutely sure to disconnect the AC cord plug at the socket outlet first.

Press the Power switch on the Plasma Display to turn the set on: Power-On.

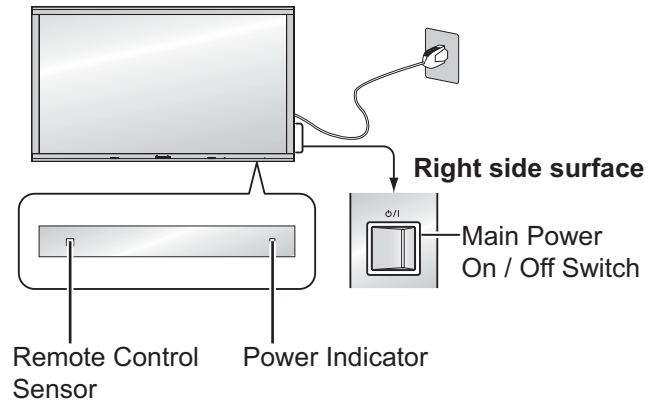

Power Indicator: Green



Press the  button on the remote control to turn the Plasma Display off.

Power Indicator: Red (standby)



Press the  button on the remote control to turn the Plasma Display on.

Power Indicator: Green

Turn the power to the Plasma Display off by pressing the  switch on the unit, when the Plasma Display is on or in standby mode.

### Note:

During operation of the power management function, the power indicator turns orange in the power off state.



**When first switching on the unit**

Following screen will be displayed when the unit is turned on for the first time. Select the items with the remote control. Unit buttons are invalid.

**OSD Language**

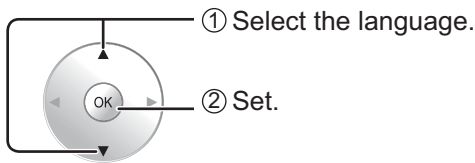

**Notes:**

- Once the language is set, this screen won't be displayed when switching on the unit next time.
- After the setting, language selection can be done from the Setup menu. (see page 43)

**3D Safety Precautions**

If the power is turned on for the next and subsequent times, 3D Safety Precautions are displayed.

If you do not want to show this message, set to hide it in the "3D Safety Precautions" on the Options menu. (see page 54)

When 3D images will be viewed by unspecified number of people or used for commercial applications, someone in authority should convey the following precautions. These precautions should be followed in the home as well.

**3D Viewing/ 3D Content/ Viewing distance/ 3D Eyewear recommendations**

- To enjoy 3D images safely and comfortably, please read the Operating Instructions fully.

# Selecting the input signal



Press to select the input signal to be played back from the equipment which has been connected to the Plasma Display.

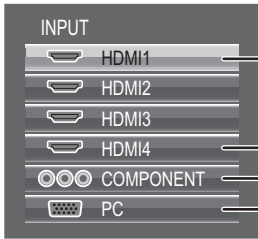

HDMI input terminals in HDMI 1 to HDMI 4.

Component or RGB input terminal in COMPONENT/RGB IN.\*

PC input terminal in PC IN.

\* "COMPONENT" may be displayed as "RGB" depending on the setting of "Component/RGB-in select". (see page 41)



When an optional Terminal Board is installed:

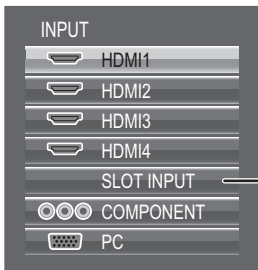

Input terminal in Terminal Board

When a dual input Terminal Board is installed, "SLOT INPUT A" and "SLOT INPUT B" are displayed.

## Using dedicated buttons for input selection



Press to select HDMI signal terminals in HDMI 1 to HDMI 4.



Press to select component or RGB signal terminal in COMPONENT/RGB IN.



Press to select PC signal terminal in PC IN.



Press to select Input terminal in Terminal Board.

For dual input Terminal Board, you can select either input terminal using A or B button.

## Notes:

- Selecting is also possible by pressing the INPUT button on the unit.
- Select to match the signals from the source connected to the component/RGB input terminals. (see page 41)
- Image retention (image lag) may occur on the plasma display panel when a still picture is kept on the panel for an extended period. The function that darkens the screen slightly is activated to prevent image retention (see page 60), but this function is not the perfect solution to image retention.

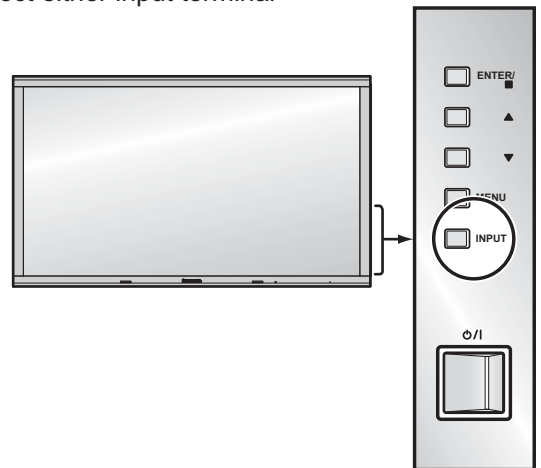

# Basic Controls

## Main Unit

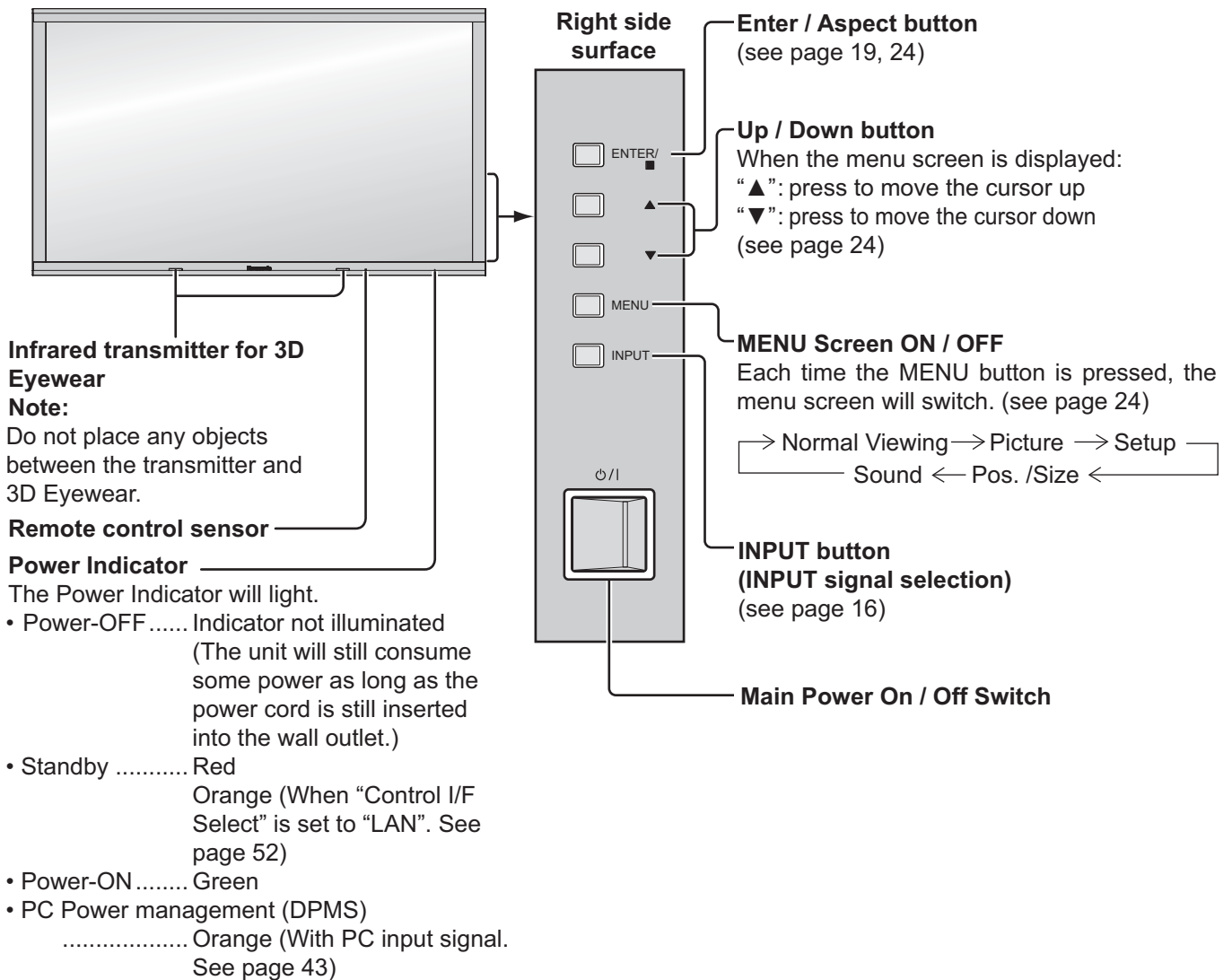

# Basic Controls

## Remote Control Transmitter

### Standby (ON / OFF) button

The Plasma Display must first be plugged into the wall outlet and turned on at the power switch (see page 14).

Press this button to turn the Plasma Display On, from Standby mode. Press it again to turn the Plasma Display Off to Standby mode.

### LIGHT button

The remote control's buttons illuminate.

### AUTO SETUP button

Automatically adjusts the position/ size of the screen. (see page 26)

### HDMI buttons

Press to select HDMI 1 to HDMI 4 input. (see page 16)

### PICTURE button

(see page 28)

### OK button

Press to make selections.

### Cursor buttons

**EXIT button**  
Exits from Menu screen.

### SLOT buttons

Press to select SLOT Terminal Board. (see page 16)

### INPUT button

Press to select input signal sequentially. (see page 16)

### RECALL button

Press the "RECALL" button to display the current system status.

- ① Input label
- ② Aspect mode (see page 19)  
During 3D images (see page 44)  
Profile name (see page 36)  
NANODRIFT Saver operating (see page 49)
- ③ Off timer  
The off timer indicator is displayed only when the off timer has been set.

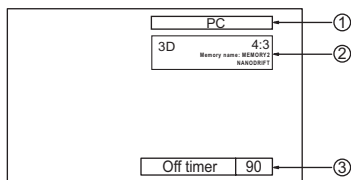

### ASPECT button

Press to adjust the aspect. (see page 19)

### Numeric buttons

(see page 36)

### MEM. LOAD button

(see page 36)

### PC button

Press to select PC input. (see page 16)

### COMPO. button

Press to select Component or RGB input. (see page 16)

### MENU button

Displays menu screen. (see page 24)

### POS. /SIZE button

(see page 25)

### RETURN button

(see page 24)  
Press the RETURN button to return to previous menu screen.

### FUNCTION buttons

(see page 54)

### VIDEO MENU button

Press to select Picture Mode. (see page 29)

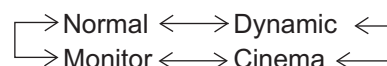

### EX.SCALER button

(see page 42)

### OFF TIMER button

The Plasma Display can be preset to switch to stand-by after a fixed period. The setting changes to 30 minutes, 60 minutes, 90 minutes and 0 minutes (off timer cancelled) each time the button is pressed.

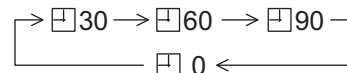

When three minutes remain, "Off timer 3" will flash.

The off timer is cancelled if a power interruption occurs.

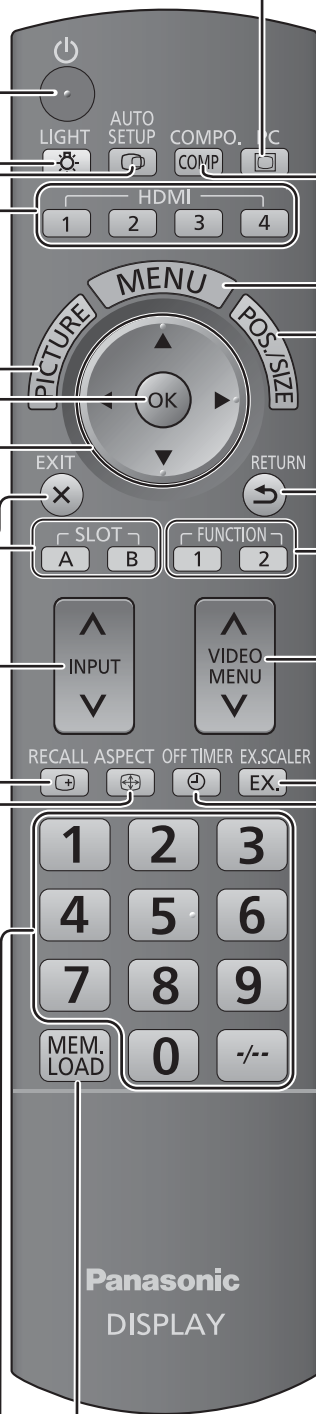

# ASPECT Controls

The Plasma Display will allow you to enjoy viewing the picture at its maximum size, including wide screen cinema format picture.

## Note:

Be aware that if you put the display in a public place for commercial purposes or a public showing and then use the aspect mode select function to shrink or expand the picture, you may be violating the copyright under copyright law. It is prohibited to show or alter the copyrighted materials of other people for commercial purposes without the prior permission of the copyright holder.



Press repeatedly to move through the aspect options:  
For details about the aspect mode, please see "List of Aspect Modes" (page 61).

[from the unit]

## Right side surface

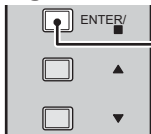

The aspect mode changes each time the ENTER button is pressed.



For VIDEO (S VIDEO) signal input:

→ 4:3 → Zoom1 → Zoom2 → Zoom3 → 16:9 → 14:9 → Just →

For PC signal input:

For SD signal input (525 (480) / 60i • 60p, 625 (575) / 50i • 50p):

→ 4:3 → Zoom → 16:9 → 4:3 → Zoom1 → Zoom2 → Zoom3 → 16:9 → 14:9 → Just →

For HD signal input [1125 (1080) / 60i • 50i • 60p • 50p • 24p • 25p • 30p • 24sF, 1250 (1080) / 50i, 750 (720) / 60p • 50p]:

→ 4:3 → 4:3 Full → Zoom1 → Zoom2 → Just ← 14:9 ← 16:9 ← Zoom3 ←

[For 3D images]

The aspect is fixed as "16:9" and you cannot switch.

## Notes:

- The aspect mode is memorized separately for each input terminal.
- Do not allow the picture to be displayed in 4:3 mode for an extended period, as this can cause a permanent image retention to remain on the Plasma Display Panel.

## All Aspect mode

Set "All Aspect" to "On" in Options menu to enable the extended aspect mode (page 53). When All Aspect mode, the aspect mode of pictures is switched as follows. For details about the aspect mode, please see "List of Aspect Modes". (page 61)

For VIDEO (S VIDEO) signal input:

→ 4:3 → Zoom1 → Zoom2 → Zoom3 → 16:9 → 14:9 → Just →

For PC signal input:

For SD signal input (525 (480) / 60i • 60p, 625 (575) / 50i • 50p):

→ 4:3 → Zoom → 16:9 → 4:3 → Zoom1 → Zoom2 → Zoom3 → 16:9 → 14:9 → Just →

For HD signal input [1125 (1080) / 60i • 50i • 60p • 50p • 24p • 25p • 30p • 24sF, 1250 (1080) / 50i, 750 (720) / 60p • 50p]:

→ 4:3 Full → Zoom1 → Zoom2 → Zoom3 → 16:9 → 14:9 → Just1 → Just2 → 4:3 (1) → 4:3 (2) →



# Viewing 3D images

You can enjoy viewing 3D images with contents or programmes corresponding to the 3D effect by wearing the 3D Eyewear (supplied).

This display supports “Frame Sequential\*1”, “Side by Side\*2” and “Top and Bottom\*3” 3D formats.

\*1: The 3D format that the images for the left and right eyes are recorded with the high definition quality and alternately played back

\*2, \*3: Other available 3D formats

## 3D Eyewear

### 3D Eyewear set

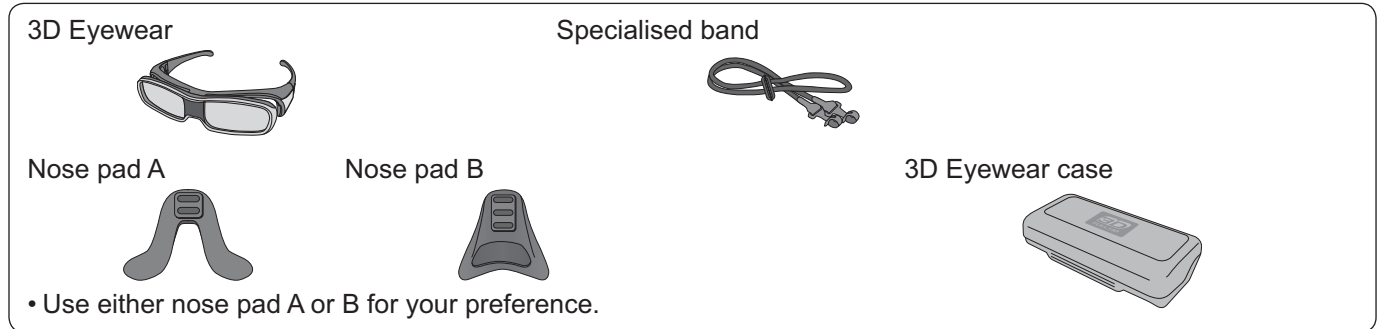

- 3D Eyewear can be worn over vision correction glasses.

### ■Part names and functions

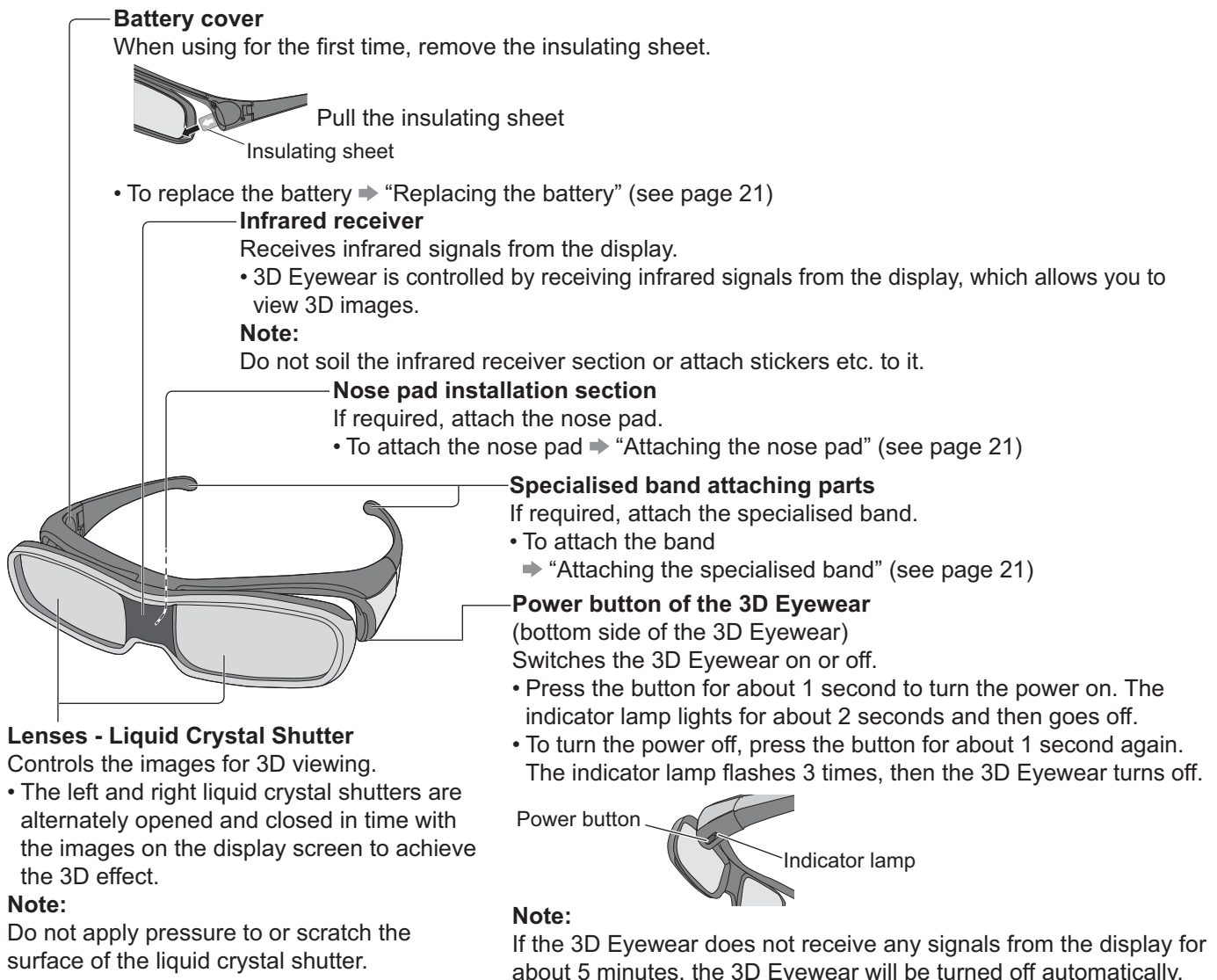



## ■ Replacing the battery

When the battery is running low, the indicator lamp flashes 5 times on turning the 3D Eyewear on. In this case, early battery replacement is recommended.

- Dispose of the old batteries as non-burnable rubbish, or in line with the waste disposal regulations in your local area.

① Loosen the screw and remove the battery cover using the supplied screwdriver

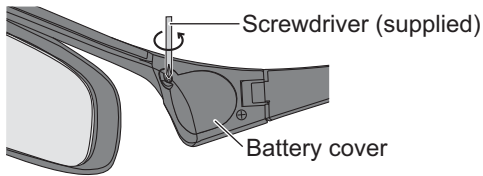

② Replace the battery

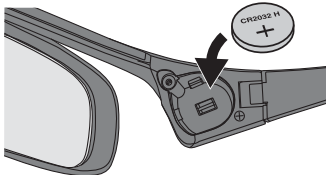

- Use the specified type of battery (coin-shaped lithium battery CR2032).
- Note the correct polarity (+ or -).

③ Replace and fasten the battery cover

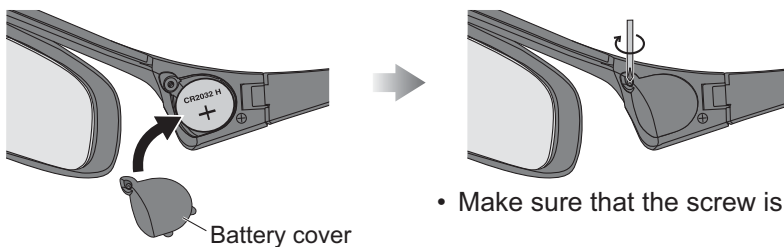

- Make sure that the screw is tightened.

## ■ Attaching the nose pad

Use either nose pad A or B for your preference.

- If you put the 3D Eyewear on vision correction glasses, the nose pad is recommended to be removed.
- You can select the positions of the nose pad A from the 2 levels of height. Use upper 2 protrusions or lower 2 protrusions on the 3D Eyewear to attach the nose pad A.
- Use all 3 protrusions on the 3D Eyewear to attach the nose pad B.

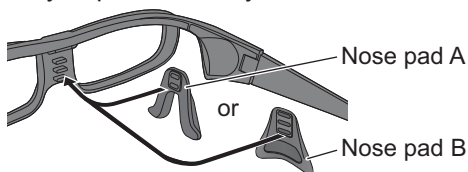

## ■ Attaching the specialised band

If the 3D Eyewear slips out of place, use the supplied specialised band to hold it in place.

- Attach the band to the left and right tips of the frame, and adjust the length.



When the end of the specialised band is straightened, form a loop at the end of the band, and fix the twisted part.

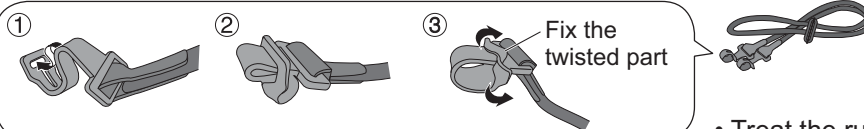

- Treat the rubber part carefully not to break it.

## ■ Storing and cleaning the 3D Eyewear

- Use the supplied 3D Eyewear case to store the 3D Eyewear.
- Avoid storing the 3D Eyewear in hot or highly humid locations.
- Use a clean, soft and dry cloth to wipe the 3D Eyewear. Otherwise, dirt or dust may scratch the eyewear.
- Do not use benzene, thinner, or wax on the 3D Eyewear, as doing so may cause the paint to peel off.
- Do not submerge the 3D Eyewear in liquid such as water when cleaning.

# To view the 3D images

---

### To view the contents of the Frame Sequential format (ex. 3D-compatible Blu-ray Disc, etc.) with 3D effect

Connect the 3D-compatible player via an HDMI cable (see page 11) and playback the contents.

- Use fully wired HDMI compliant cable.
- For the settings of the player, read the manual of the player.
- If you use the non 3D-compatible player, the images will be displayed without 3D effect.

### To view the contents of 3D formats other than Frame Sequential with 3D effect.

Match the picture format in “3D Picture Format” (see page 44) before viewing.

- You can view “Side by Side” and “Top and Bottom” with 3D effect even if you use the non 3D-compatible player.
- Please consult the suppliers of contents or programmes for availability of this service.

#### ① Turn the 3D Eyewear on

- Press the power button on the 3D Eyewear for about 1 second. (see page 20)

#### ② Put on the 3D Eyewear

- If the 3D Eyewear slips out of place, hold it in place using the specialised band, and adjust the length of the band. (see page 21)

#### ③ Watch the 3D images

### ■ To turn the 3D Eyewear off

After using the 3D Eyewear, press the power button on the 3D Eyewear for about 1 second to turn it off. (see page 20)

#### Notes:













- If the room is lit by fluorescent lights (50 Hz) and light appears to flicker when using the 3D Eyewear, switch off the fluorescent light.
- 3D content will not be correctly visible if the 3D Eyewear is worn upside down or back-to-front.
- Do not wear the 3D Eyewear when watching anything other than 3D images. Liquid crystal displays (such as computer screens, digital clocks or calculators, etc.) may be difficult to see while wearing the 3D Eyewear.
- Do not use the 3D Eyewear as sunglasses.
- 3D effects may be perceived differently depending on the person.

## Troubleshooting for 3D Eyewear

Symptoms	Checks
Cannot see 3D images	<ul style="list-style-type: none"> <li>• Has the 3D Eyewear been switched On?</li> <li>• Ensure that “3D Picture Display” in “3D Settings” is set to “3D”. (see page 44)</li> <li>• Some 3D image signals may not be automatically recognized as 3D images. Set “3D INPUT FORMAT” in “3D Settings” to match the picture format. (see page 44)</li> <li>• Check that there are no obstacles between the infrared sensors on the display and the 3D Eyewear. If the 3D Eyewear stops receiving the infrared signal for about 5 minutes, the 3D Eyewear will be turned off automatically.</li> <li>• Check the available area to use the 3D Eyewear. (see page 22)</li> <li>• Depending on the person, the 3D images may be difficult to see, or cannot be seen, especially in users that have a different level of eyesight between the left and right eyes. Take the necessary steps (wearing glasses etc.) to correct your eyesight before use.</li> </ul>
3D Eyewear is turned off automatically	<ul style="list-style-type: none"> <li>• Check that there are no obstacles between the infrared sensors on the display and the 3D Eyewear or that the 3D Eyewear is placed inside the coverage area (see page 22). If the 3D Eyewear stops receiving the infrared signal for about 5 minutes, the 3D Eyewear will be turned off automatically.</li> </ul>
There is something wrong with the 3D images	<ul style="list-style-type: none"> <li>• Check the setting of “3D Picture Sequence”. (see page 44)</li> </ul>
The indicator lamp does not light when pressing the power button on the 3D Eyewear	<ul style="list-style-type: none"> <li>• The battery may be running low or flat. Replace it.</li> <li>• If the indicator lamp does not light after the power button has been pressed for more than 1 second, the battery may be running low or flat. Replace it.</li> </ul>

## Table of images that can be seen for each 3D Picture Format and the source image format

If the picture appears to be abnormal, refer to the table below to choose the correct 3D picture format setting.

3D Picture Format \ Source image format	Auto	Side by Side	Top and Bottom	Native
Side by side	 *1	 Normal*2		
Top and bottom	 *1		 Normal*2	
Normal format (2D)	 Normal			 Normal

\*1 When the source image is not recognized correctly

\*2 When “3D Picture Display” is set to “3D”, the images will be displayed with 3D effect. When set to “2D”, displayed without 3D effect.

• Depending on the player or contents, the image may be different from the above illustrations.

# On-Screen Menu Displays

## 1 Display the menu screen.

### Remote Control



### Unit



Each time the MENU button is pressed, the menu screen will switch.

## 2 Select the menu.

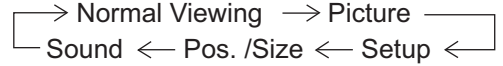
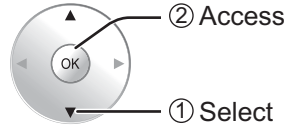
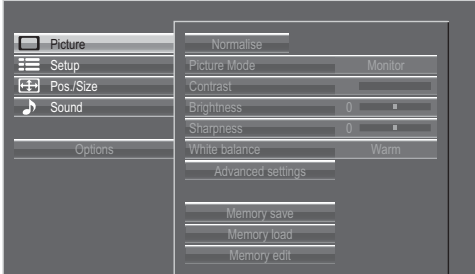

The menu can be displayed directly by pressing these buttons. (see page 25, 28)

## 3 Select the item.

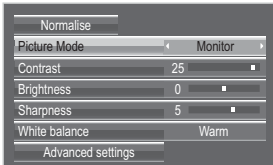

(Example: Picture menu)

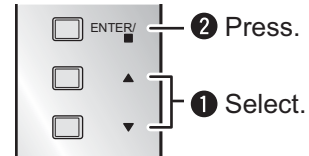

## 4 Set.

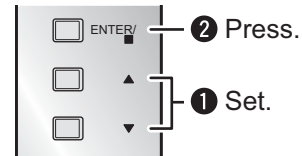

## 5 Exit the menu.



Press to return to the previous menu.

## Menu display list

### Picture menu

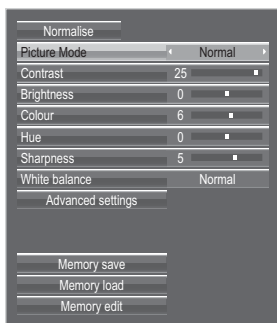

see page 28-39

### Setup menu

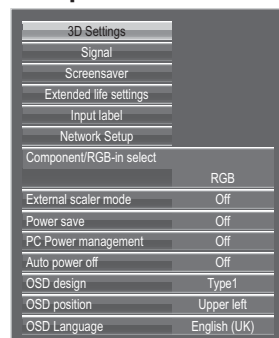

see page 41-52

### Pos. /Size menu

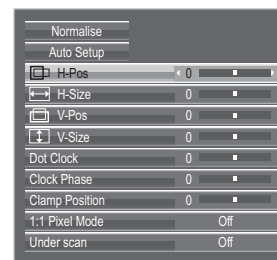

see page 25-27

### Sound menu



see page 40

# Adjusting Pos. /Size

1 Display the menu screen.



2 Select "Pos. /Size".

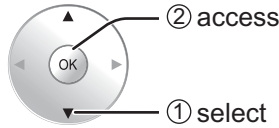

3 Select the item and set.

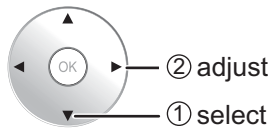
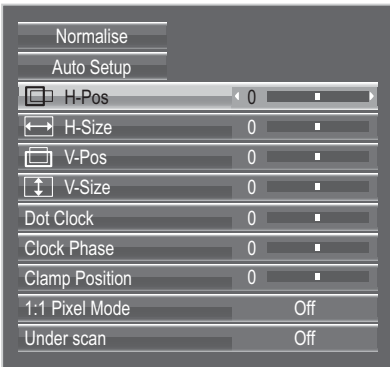

**Note:**

Unadjustable items are grayed out.

Adjustable items differ depending on the input signal and the display mode.

4 Exit the menu.



To display a menu for adjustment of the Pos. /Size menu on the bottom of the screen

To hide the menu

**Notes:**

- Adjustment details are memorized separately for different input signal formats (Adjustments for component signals are memorized for 525 (480) / 60i · 60p, 625 (575) / 50i · 50p, 1125 (1080) / 60i · 50i · 60p · 50p · 24p · 25p · 30p · 24sF, 1250 (1080) / 50i, 750 (720) / 60p · 50p each, and RGB/PC/Digital signals are memorized for each frequency.)
- If a "Cue" or "Rew" signal from a VCR or DVD player is received, the picture position will shift up or down. This picture position movement cannot be controlled by the Picture Pos./Size function.

## Helpful Hint (Normalise Normalization)

While the Pos. /Size display is active, if the OK button is pressed during "Normalise", then all adjustment values are returned to the factory settings.

# Adjusting Pos. /Size

## ● Auto Setup

H-Pos/V-Pos, H-Size/V-Size, Dot Clock and Clock Phase are automatically adjusted when the RGB or PC signal is received.

This setting is enabled under the following conditions:

- When “Component/RGB-in Select” or “YUV/RGB-in select” in the “Setup” menu (see page 41) is set to “RGB”, this setting is enabled.
- When the signal is not PC format, this setting is enabled only if “Over scan” (see page 27) is “Off” or “1:1 Pixel Mode” (see page 27) is “On”, and H-Size/V-Size is not automatically adjusted.

This setting will be invalid and will not work under the following conditions:

- Aspect is set to “Just”
- “Under scan” is set to “On”

### Using Remote Control



When  on the remote control is pressed, “Auto Setup” will be executed.

When Auto Setup does not work, “Invalid” is displayed.

### Auto mode

When the “Auto Setup” is set to “Auto” in the Options menu (see page 53), automatic position adjustment starts:

- When the display power is turned ON.
- When the input signal is switched.

### Notes:

- If the dot clock frequency is 162 MHz or higher, Dot Clock and Clock Phase cannot be made.
- When digital RGB signal input, Dot Clock and Clock Phase cannot be made.
- Auto Setup may not work when a cropped or dark image is input. In such case, switch to a bright image with borders and other objects are clearly shown, and then try auto setup again.
- Depending on the signal, out of alignment may occur after Auto Setup. Carry out fine tuning for the position/size as required.
- If Auto Setup cannot set properly for vertical frequency 60Hz XGA signal (1024×768@60Hz, 1280×768@60Hz, and 1366×768@60Hz), pre-selecting the individual signal in “XGA Mode” (see page 45) may results in correct Auto Setup.
- Auto Setup does not work well when a signal such as additional information is superimposed out of valid image period or intervals between synchronizing and image signals are short, or for image signal with tri-level synchronizing signal added.
- If Auto Setup cannot adjust correctly, select “Normalise” once and press OK button, then adjust Pos. /Size manually.

## ● H-Pos

Adjust the horizontal position.

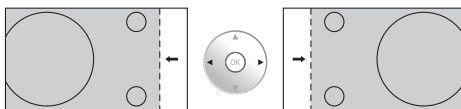

## ● V-Pos

Adjust the vertical position.

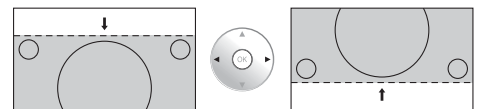

## ● H-Size

Adjust the horizontal size.

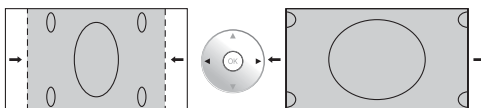

## ● V-Size

Adjust the vertical size.

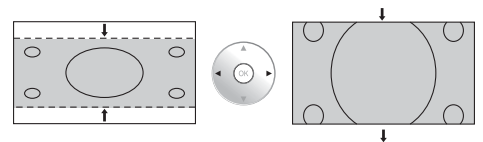

## ● Dot Clock

**(During Component, RGB and PC input signal)**

Periodic striped pattern interference (noise) may occur when a striped pattern is displayed. If this happens, adjust so that any such noise is minimized.

## ● Clock Phase **(During Component, RGB and PC input signal)**

Eliminate the flickering and distortion.

## • Over scan

Turn image over scan On/Off.

Configurable signals are as follows:

525i, 525p, 625i, 625p, 750/60p, 750/50p (Component Video, RGB, DVI, SDI, HDMI)

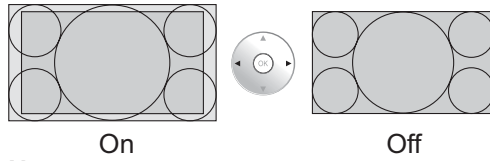

### Notes:

- When "Off" is set, "H-Size" and "V-Size" cannot be adjusted.
- When the "Under scan" is set to "On", this setting will be invalid.

## • Clamp Position

(During Component and RGB input signal)

Adjusts the clamp position when black parts of the image have no detail due to underexposure or are tinged with green.

### Optimum value for Clamp Position adjustment

When black parts have no detail due to underexposure (blackout)

→ Value that causes least blackout is the optimum.

When black parts are tinged with green

→ Value that cancels the greenishness without causing blackout is the optimum.

## • 1:1 Pixel Mode

Adjusts the display size when 1125i, 1125p or 1250i signal is input.

### Notes:

- Select On when you would like to replay 1920 × 1080 input signal.
- Applicable input signal;  
1125 (1080) / 50i · 60i · 24sF · 24p · 25p · 30p · 50p · 60p, 1250 (1080) / 50i
- Select Off when flickering is shown around the image.
- H-Size and V-Size cannot be adjusted when On is selected.

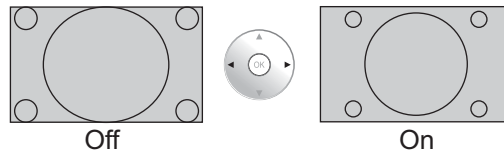

## • 1:1 Pixel Mode (2k1k) (For 2k1k signals)

When the input signal is a 2k1k signal (2048 × 1080 / 24p, 2048 × 1080 / 24sF), the display size is adjusted as follows.

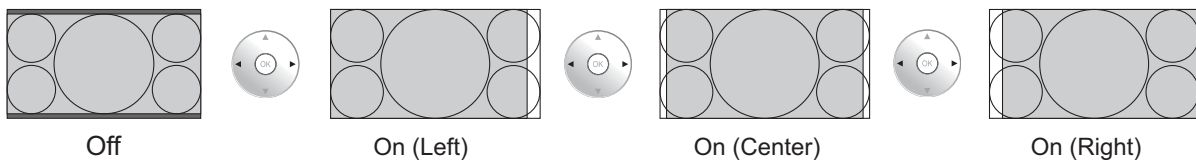

### Note:

2k1k signals can only be received when the Dual Link HD-SDI Terminal Board (TY-FB11DHD) is installed.

## • Under scan

Adjusts the image display size on screen.

**Off:** Sets the normal image display size on screen.

**On:** Sets the image display size approximately 95 % of the normal image display.

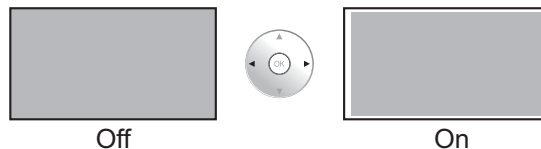

### Notes:

- "Under scan" can be modified when "Studio mode" in the Options menu is "On". When "Studio mode" is "Off", this setting is "Off" and cannot be changed. (see page 53)
- This setting is valid only when the input signals are as follows;  
525i, 525p, 625i, 625p, 750/60p, 750/50p, 1125/60i, 1125/50i, 1125/24sF, 1125/25p, 1125/24p, 1125/30p, 1125/60p, 1125/50p, 1250/50i (RGB, DVI, SDI, HDMI)
- When "Under scan" is set to "On", "H-Pos" and "V-Pos" in "Pos. /Size" can be adjusted.
- Refer to each board's operating instruction for DVI, SDI's corresponding signals.

# Picture Adjustments

1 Display the menu screen.



2 Select "Picture".

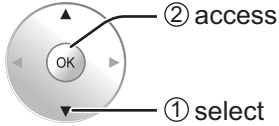
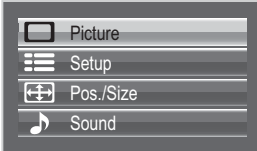

3 Select the item and set.

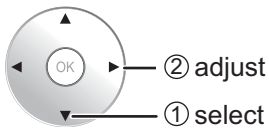
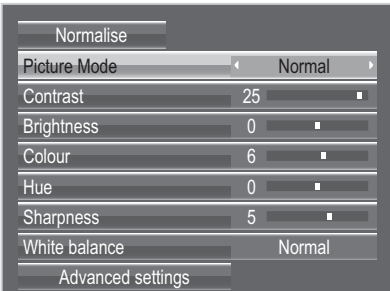

**Note:**

Menu that cannot be adjusted is grayout. Adjustable menu changes depending on signal, input and menu setting.

4 Exit the menu.



To display a menu for adjustment of the Picture menu on the bottom of the screen,

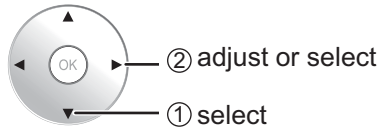

To display a menu for Advanced settings adjustment, press PICTURE button again.



To hide the menu

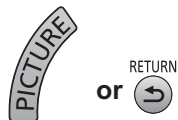

## Helpful Hint (Normalise Normalization)

While the "Picture" menu is displayed, if the OK button is pressed during "Normalise", then all adjustment values are returned to the factory settings.



## ● Picture Mode

You can switch to the optimal picture mode for the video source and viewing environment.

### Normal:

For viewing in standard (evening lighting) environments. This menu selects the normal levels of Brightness and Contrast.

### Dynamic:

For viewing in brighter environments. This menu selects higher than normal levels of Brightness and Contrast.

### Notes:

- When "Monitor" is selected in Picture Mode, the following menu items cannot be set.  
Picture menu: Contrast  
Extended life settings: Peak limit (see page 49)  
Setup menu: Power save (see page 43)
- If you would like to change the picture and colour of the selected Picture menu to something else, adjust using the items in the Picture menu. (see below)

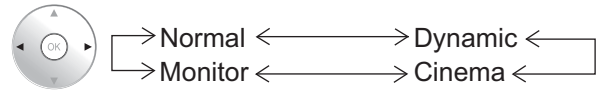

### Cinema:

Ideal for movies.

### Monitor:

For use when creating broadcast or movie content. With this picture, even if the overall average picture level (APL) changes, the brightness of areas with the same signal level does not change.

● **Contrast** Adjusts the proper picture contrast.

● **Brightness** Adjusts for easier viewing of dark pictures such as night scenes and black hair.

● **Colour** Adjusts colour saturation.

● **Hue** Adjusts for nice skin colour.

● **Sharpness** Adjusts picture sharpness.

Less  More

Darker  Brighter

Less  More

Reddish  Greenish

Less  More

● **White balance** Switches to various screen color tones.

**Normal:** Intermediate color temperature.

**Warm:** Colors with a reddish tinge.

**Warm2:** Colors with a reddish tinge (6100K).

**Warm3:** Colors with a reddish tinge (5600K).

**Studio:** Optimal color temperature for studio viewing (3200K).

**Cool:** Colors with a bluish tinge.

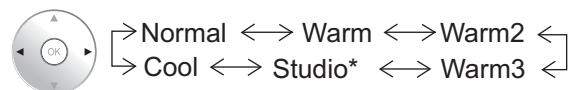

\* "Studio" can be modified when "Studio mode" in the Options menu is "On". (see page 53)

### Notes:

- You can change the level of each function (Contrast, Brightness, Colour, Hue, Sharpness) for each Picture Mode.
- The setting details for Normal, Dynamic, Cinema and Monitor respectively are memorized separately for each input terminal.
- In Contrast, there is not a noticeable change even when contrast is increased with a bright picture or reduced with a dark picture.

## Advanced settings

Enables fine picture adjustment at a professional level.

**Notes:**

- The adjustment values are memorized separately for each input terminal.
- The adjustment range values should be used as an adjustment reference.

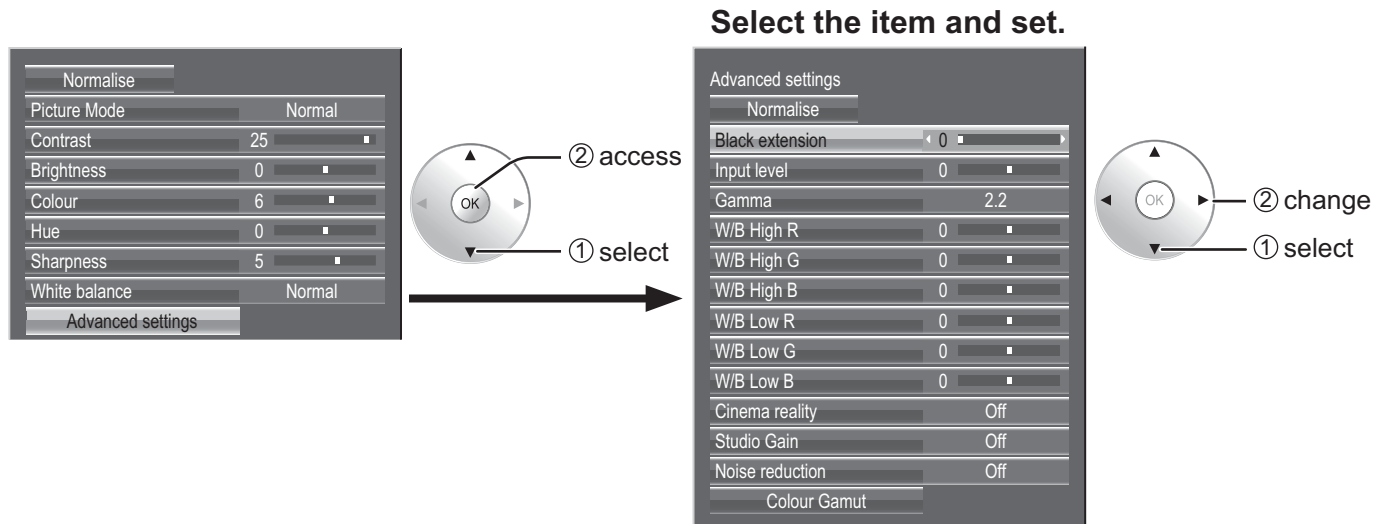

- Black extension** Adjusts the dark shades of the image in gradation.
 

Less  More
- Input level** Adjustment of parts which are extremely bright and hard to see.
 

Less  More
- Gamma**

↳ S Curve ◀────────▶ 1.0\* ◀────────▶ 2.0 ◀────────▶ 2.2 ◀────────▶ 2.6 ◀

\* When 2k1k signals are received with the Dual Link HD-SDI Terminal Board (TY-FB11DHD), Gamma “1.0” cannot be selected.

Down  Up
- “W/B” adjustment**

W/B High R	◀ 0
W/B High G	◀ 0
W/B High B	◀ 0
W/B Low R	◀ 0
W/B Low G	◀ 0
W/B Low B	◀ 0

Adjusts the white balance for light red, light green or light blue areas.

Adjusts the white balance for dark red, dark green or dark blue areas.

Less  More

Carry out “W/B” adjustment as follows.

1. Adjust the white balance of the bright sections using the “W/B High R”, “W/B High G” and “W/B High B” settings.
2. Adjust the white balance of the dark sections using the “W/B Low R”, “W/B Low G” and “W/B Low B” settings.
3. Repeat steps 1 and 2 to adjust.

Steps 1 and 2 affect each other’s settings, so repeat each step in turn to make the adjustment.

- **Cinema reality** When “on”, the display attempts to reproduce a more natural interpretation of sources such as movie pictures, which are recorded at 24 frames per second. If the picture is not stable, turn the setting to “off”.



**Note:**

When “On”, this setting only affects the following signal input:

- 525i (480i), 625i (575i), 1125 (1080) / 60i signal input during “Component” input signal.

- **Studio Gain** Sharpens the contrast for a better view when a part of the image is too light to see.



**Off:** Disables “Studio Gain”.

**On:** Enables “Studio Gain”.

**Notes:**

- “Studio Gain” can be modified when “Studio mode” in the Options menu is “On”. When “Studio mode” is “Off”, this setting is “Off” and cannot be changed. (see page 53)
- This setting is valid only when the input signals are as follows:  
Component Video, RGB (analog), SDI, HDMI

- **Noise reduction** Sets the following three NR (Noise Reduction) functions together.  
P-NR, Block NR, Mosquito NR

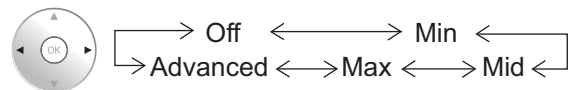

**[Advanced NR]**

Sets the three NR functions separately.

**1 Select “Advanced”.**

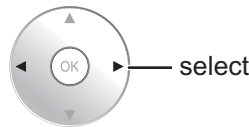

**2 Select the item and set.**

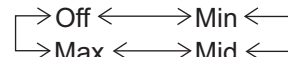
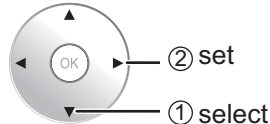

**P-NR:** Automatically reduces unwanted picture noise.

**Block NR:** Reduces block noise when playing MPEG videos.

**Mosquito NR:** Reduces mosquito noise around subtitles on MPEG videos.

**Note:**

“Noise reduction” cannot be adjusted while a PC signal is being applied.

**Helpful Hint (Normalise Normalization)**

On the remote control unit, while the “Advanced settings” menu is displayed, if the OK button is pressed during “Normalise”, then all adjustment values are returned to the factory settings.

## Colour space adjustment (Colour Gamut)

Changes the colour space to BT.709 signal standard chromaticity point and fine-tunes it.

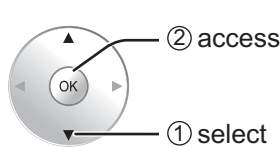
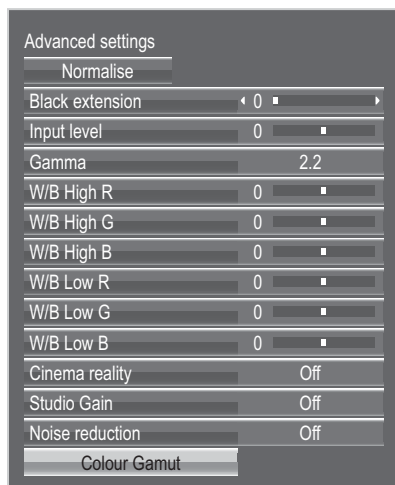

### Select the item and set.

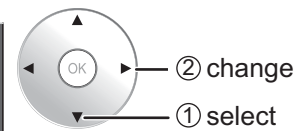
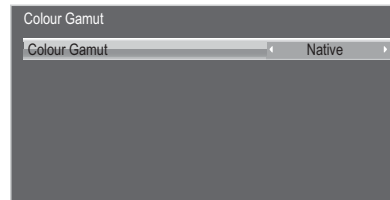

### • Colour Gamut

**DIGITAL CINEMA COLOUR:** Sets color gamut to reproduce the original color of movies.

**Custom:** Enables the colour space adjustment, the colour space adjustment set in the “EDIT” is reflected.

**Native:** Disables the colour space adjustment, images are displayed in the original colour gamut of the panel.

**HDTV Colour:** Changes the colour space to BT.709 signal standard chromaticity point.

#### Notes:

- This setting is memorized separately for each input terminal and “Picture Mode”.
- For 3D images, this setting becomes “Native” and no setting is available.

### • Edit

Colour space is fine-tuned.

#### Notes:

- This setting is valid when “Colour Gamut” is “Custom”.
- This setting is memorized separately for each input terminal and “Picture Mode”.

1 Select “Edit”.

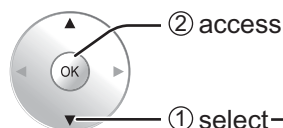

2 Select an adjustment item.

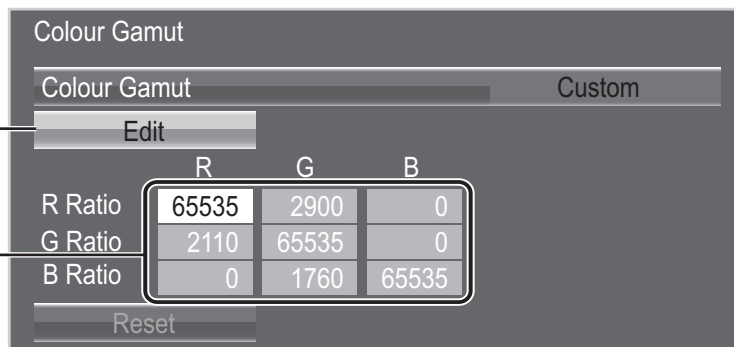
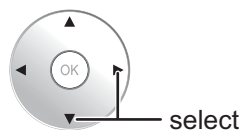

3 Change the numerical value. 65535

[To adjust with the ▲ ▼ button]

- 1 Press the button.
- 2 Change the numerical value with the ▲ ▼ button.
- 3 Press the button.

[To input the numerical value directly]

- 1 Input the numerical value from 0 to 9
- Pressing the will cancel the value change.
- 2 Press the button.

4 Press the button.  
Adjustment is ended.

- **Reset** Resets the adjustment value of colour space.

**Note:**

This setting is reflected only for the selected input terminal and the “Picture Mode”.

- 1 Select “Reset”.

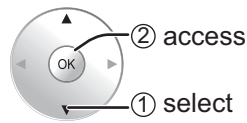
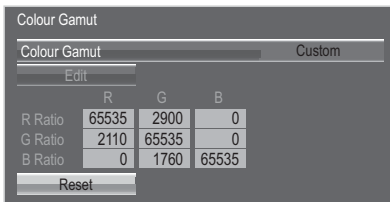

- 2 Select “Ok”.

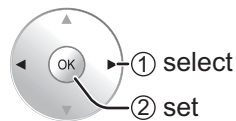
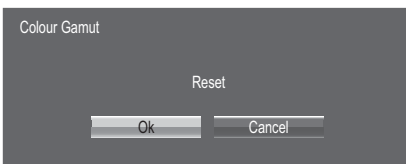

- **Chromaticity diagram** The RGB triangle representing current colour space is shown.

**Colour Gamut: Custom**

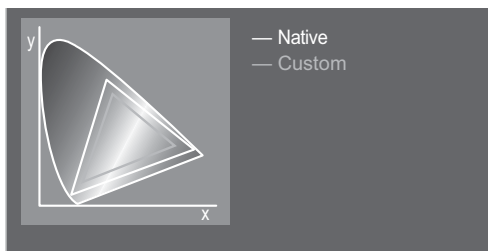

White line: Colour gamut with “Native” setting (original colour gamut.)  
 Yellow line: Colour gamut with “Custom” setting (current colour gamut.)

# Picture Profiles

Up to 16 combinations of picture adjustment values (in the Picture menu and Advanced settings) can be stored in the display memory as profiles and applied as needed, for a convenient way to enjoy your preferred picture settings.

**Note:**

If setting items (Picture menu and Advanced settings) are set differently between Memory save and Memory load, they may not reflect for Memory load.

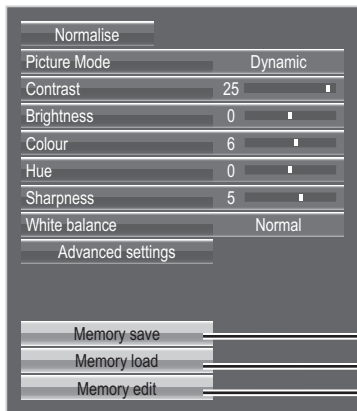

**Save profiles**(page 35)

**Load profiles**(page 36)

**Edit profiles**(page 37)

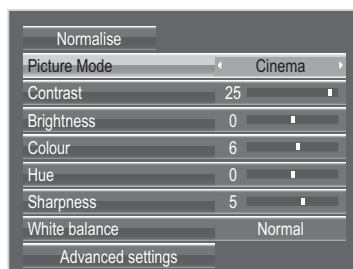

**Save profiles**

Save the picture adjustment values in the MEMORY1 profile

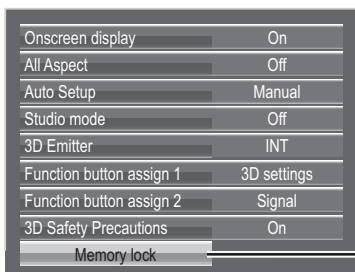

**Lock profiles**(page 38, 39)

**Edit the profile**  
Delete or rename the profile

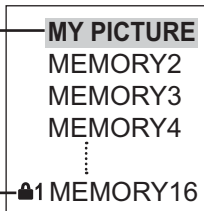

**Locked profile**

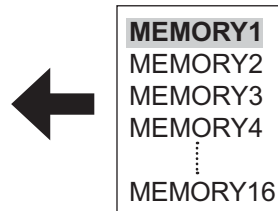

**Load the profile**

Apply the MEMORY1 profile



**Original picture**



**Custom picture**

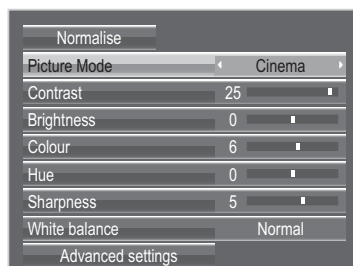
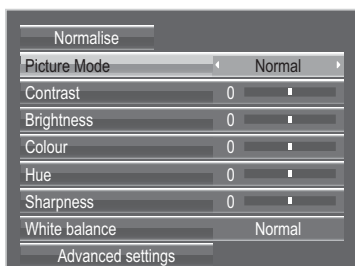

# Saving profiles

Follow these steps to save picture adjustment values as profiles.

**Note:**

When the settings are locked in “Extended life settings”, profiles cannot be saved.

**1** Specify the picture quality in the Picture menu and Advanced settings. (see page 28-33)

**2** In the Picture menu, select “Memory save”.



**3** Select a profile name for saving the picture adjustment values.

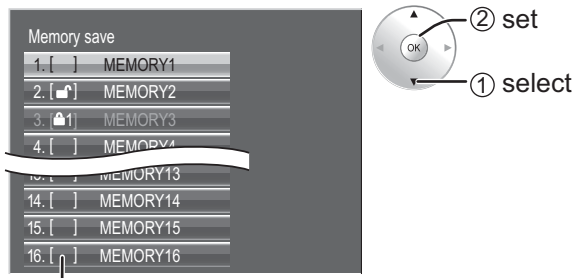

Profiles are labeled with these icons to indicate their locked status. (see page 36)

[ ] , [■]: Settings can be saved in this profile.  
 [▲1] , [▲2]: Settings cannot be saved in this profile.

**4** Select “Ok”.

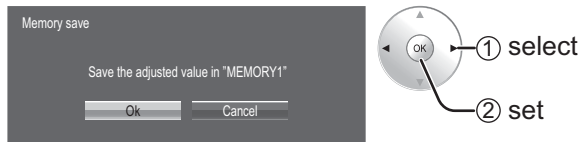

**5** Enter a name for the profile.

**[Entering profile names]**

Profile names can be up to 40 characters.

To enter text, select characters in the on-screen keyboard.

Edit the default profile name in the text box as desired.



**Example: Specifying “MY PICTURE”**

**①** Select “All delete”.



All text is deleted.

To delete individual characters, select “Delete”.

**②** Select “M”.



Repeat this process to enter the next character.

**③** Select “Y”.



**④** Select “Space”.



**6** When you finished entering the profile name, select “Ok”.

To cancel saving the profile, select “Cancel”.

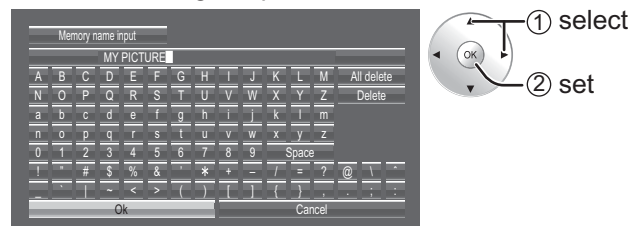

## Loading profiles

Load profiles and apply the picture adjustment values to the display as follows.

### Notes:

- Loaded profiles are stored in memory according to the selected input terminal (see page 16).
- When the settings are locked in “Extended life settings”, profiles cannot be loaded.

### <Loading profiles from the Picture menu>

**1** In the Picture menu, select “Memory load”.

**2** Select the profile to load.

Profiles are labeled with these icons to indicate their locked status. (see below)

### <Loading profiles from on the remote control>

**1** Press  to list the profiles.

**2** Select the profile to load.

Profiles are labeled with these icons to indicate their locked status. (see below)

### <Loading profiles directly from the remote control>

To load profiles 1–9

**1** Press a button in the range **1** – **9**.

**2** Select “Ok”.

To load profiles 10–16

Example: To load profile 16

**1** Press  **1** **6**.

The profile number is displayed in the upper-right corner of the screen.



**2** Select “Ok”.

### Loading locked profiles...

In the Picture menu, profiles are labeled with these icons to indicate their locked status.

**1**: Lock1  
**2**: Lock2

When profile is being loaded, profile name is displayed.

Operations with locked profiles are restricted. (see page 38)

Picture adjustment values in the Picture menu cannot be changed, except for the “Picture Mode”. Once you edit the “Picture Mode” setting, you can edit “Contrast”, “Brightness”, and other picture adjustment values.

#### **1** Lock1

Picture adjustment values are shown.

Can be specified.

Cannot be specified.

#### **2** Lock2

Picture adjustment values are hidden.

Can be specified.

Cannot be specified.



# Editing profiles

Delete or rename profiles as follows.

## <Deleting profiles>

**Note:**

Locked profiles and profiles currently in use cannot be deleted.

**1** In the Picture menu, select “Memory edit”.



**2** Select “Memory delete”.



**3** Select the profile to delete.  
To delete all profiles, select “All delete”.



**4** Select “Ok”.

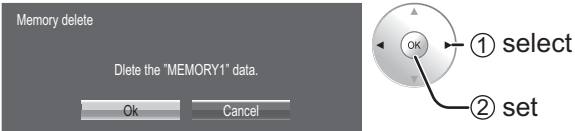

## <Renaming profiles>

**Note:**

Locked profiles cannot be renamed.

**1** In the Picture menu, select “Memory edit”.



**2** Select “Memory name change”.



**3** Select the profile to rename.



**4** Enter a name for the profile.  
Entering profile names → page 35

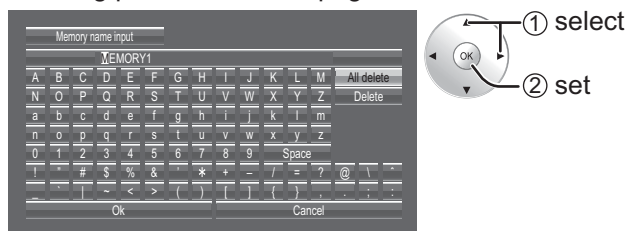

**5** When you finished entering the profile name, select “Ok”.

To cancel renaming the profile, select “Cancel”.

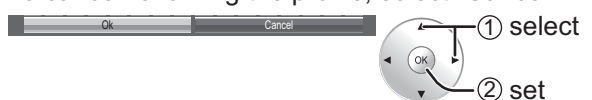



## Locking profiles

You can lock saved profiles to restrict operations when the profiles are loaded. You can also set passwords.

### Notes:

- When the lock is set in “Extended life settings”, profile cannot be locked.
- If profile is locked, the menu operations of “Extended life settings” are restricted. (see page 49)

### <Locking and unlocking profiles>

- 1 Display the menu screen. 
- 2 Select “Options” and hold  for 3 seconds or more.
 

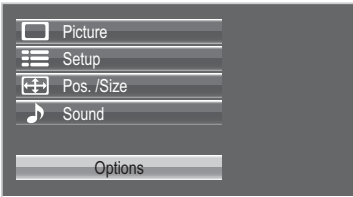

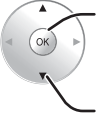

② access (3 seconds or more)

① select
- 3 Select “Memory lock”.
 

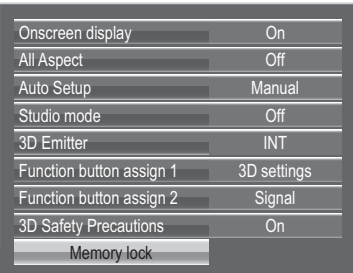



② access

① select
- 4 Enter a 4-digit password. The default password is “0123”.
 

④

③

②

①

0

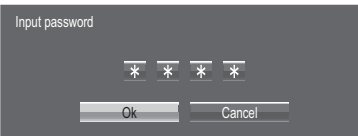

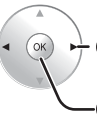

① select

② set
- 5 Select “Ok”.
 

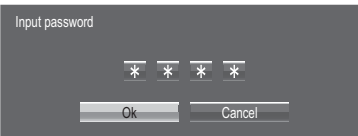

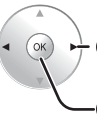

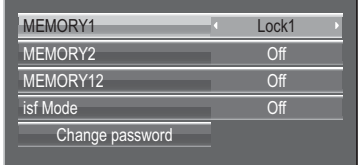

① select

② set
- 6 Select the profile and specify the desired lock setting.
 

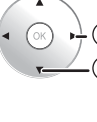



② adjust

① select
- 7 Exit the menu. 

Once a profile is locked, the following operations are restricted when the profile is loaded.

Setting	Editing the Profile (Memory edit)	Editing Picture Adjustment Values via the Menu (Picture menu, Advanced settings)	Saving Picture Adjustment Values (Memory save)
Off (unlocked)	Allowed	Allowed	Allowed
Lock1	Prohibited	Prohibited (picture adjustment values are shown)	Allowed
Lock2	Prohibited	Prohibited (picture adjustment values are hidden)	Prohibited

### <Changing passwords>

- 1 Follow steps 1–5 in the previous procedure, <Locking and unlocking profiles>.
- 2 Select “Change password”.
 

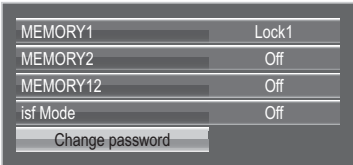



② access

① select
- 3 Enter a new 4-digit password.
 

③

②

①

0

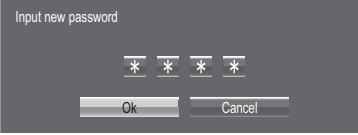

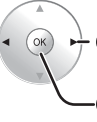

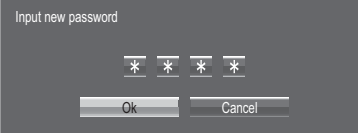

① select

② OK
- 4 Select “Ok”.
 

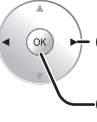



① select

② OK
- 5 Exit the menu. 

### Note:

Make a note of the new password to remember it.

## <isf Mode Setting>

Switches to "Picture Mode" mode display.

**1** Follow steps 1–5 in the previous procedure, <Locking and unlocking profiles>.

**2** Select "isf Mode".

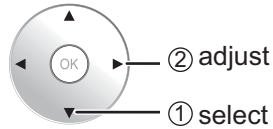
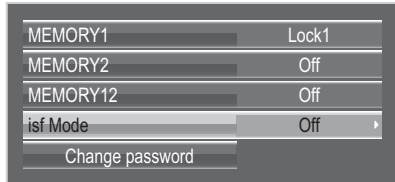

**3** Specify "On" or "Off".

**4** Exit the menu.



Specifying "On" for isf Mode changes the "Picture Mode" mode display as follows.

### "Picture Mode" mode display

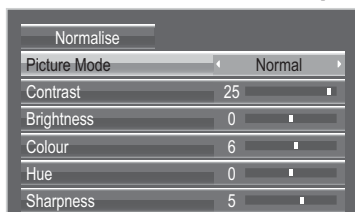

isf Mode: Off	isf Mode: On
Normal	Normal
Dynamic	isf Mode Day
Cinema	isf Mode Night
Monitor	Monitor

Mode display when  is selected

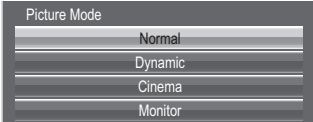
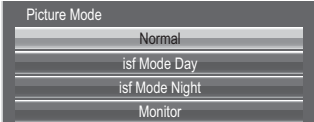

isf Mode: Off	isf Mode: On
	

# Sound Adjustment

1 Display the menu screen.



2 Select "Sound".

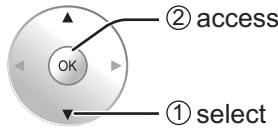

3 Select the item and set.

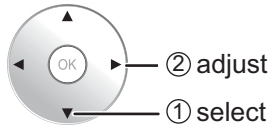

4 Exit the menu.



Item	Details
<b>Balance</b>	Adjusts left and right volumes.
<b>Volume</b>	Adjusts the sound volume level.

## Helpful Hint (Normalise Normalisation)

While the "Sound" menu is displayed, if the OK button is pressed during "Normalise", then all adjustment values are returned to the factory settings.

# SDI Sound Output

This menu is displayed when HD-SDI Terminal Board with audio (TY-FB10HD) or Dual Link HD-SDI Terminal Board (TY-FB11DHD) is installed to the unit.

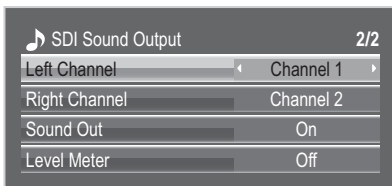

**Note:**

This menu is available only when selecting a slot that HD-SDI Terminal Board with audio (TY-FB10HD) or Dual Link HD-SDI Terminal Board (TY-FB11DHD) is installed.

Item	Details
<b>Left Channel</b>	<b>Channel 1 to Channel 16</b> Selects left audio channel.
<b>Right Channel</b>	<b>Channel 1 to Channel 16</b> Selects right audio channel.
<b>Sound Out</b>	<b>On</b> <math>\longleftrightarrow</math> <b>Off</b> <b>On:</b> Enables audio output. <b>Off:</b> Disables audio output.
<b>Level Meter</b>	<b>Off</b> <math>\longleftrightarrow</math> <b>1-8ch</b> <math>\longleftrightarrow</math> <b>9-16ch</b> Sets audio channels to show in the audio level meter. 8 channels are displayed in the audio level meter; 4 channels each on both right and left sides of the display. <b>Off:</b> Hides the audio level meter. <b>1-8ch:</b> Displays the audio level meter (1-8ch) <b>9-16ch:</b> Displays the audio level meter (9-16ch)

# Setup menu

1 Display the menu screen.



2 Select "Setup".

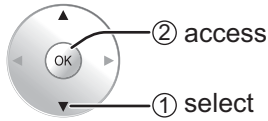
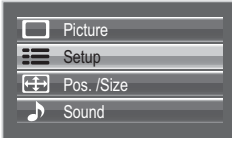

3 Select the item and set.

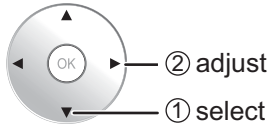
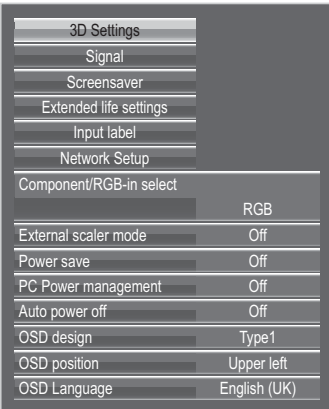

4 Exit the menu.



---

## Component / RGB-in select

---

Component  $\longleftrightarrow$  RGB

Select to match the signals from the source connected to the Component / RGB or PC input terminals.

Y, P<sub>B</sub>, P<sub>R</sub> signals  $\leftrightarrow$  "Component"

RGB signals  $\leftrightarrow$  "RGB"

**Note:**

Make setting of the selected input terminal (COMPONENT RGB IN or PC IN).

---

## YUV / RGB-in select

---

YUV  $\longleftrightarrow$  RGB

Select to match the signals from the source connected to the DVI input terminals.

YUV signals  $\leftrightarrow$  "YUV"

RGB signals  $\leftrightarrow$  "RGB"

**Notes:**

- Selection may not be possible, depending on which optional board is installed.
- Make setting of the selected input terminal (SLOT).

# External scaler mode

### Off ↔ On

This menu can be used to specify whether the built-in scaler or an external scaler is used for scaler functions such as resizing and picture quality adjustment.

The setting is valid with the following input signals.

1125 (1080) / 24p•25p•30p•50p•60p

**Off:** Use the built-in scaler.

**On:** Use an external scaler.

### Note:

If “On” is set when other than corresponding signal is input, “Input signal must be 1125p(1080p)” message is displayed.

### Using Remote Control

Each time you press <sup>EX.SCALER</sup> **EX.**, an external scaler is activated or deactivated.

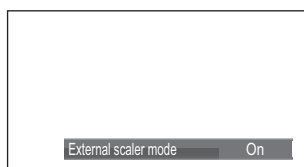

### Note:

Selecting “On” in this setting deactivates the following settings and disables these operations.

Pos. /Size menu: H-Size, V-Size, 1:1 Pixel Mode, Display size (see page 26, 27)

Picture menu: Brightness, Colour, Hue, Sharpness, Memory save, Memory load (see page 29, 35, 36)

Advanced settings: Cinema reality, Noise reduction (see page 31)

Signal menu: XGA Mode (see page 45)

Options menu: All Aspect (see page 53)

ASPECT Controls (see page 19)

“EXT. SCALER” is displayed in the menu screen to indicate that an external scaler is in use.

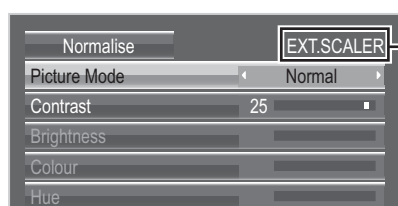

## Power save

Off ↔ On

When this function is turned On, luminous level of the Plasma Display is suppressed, so power consumption is reduced.

## PC Power management

Off ↔ On

When this function is set to On, it operates under the following conditions to turn the power on or off automatically. When no pictures (HD/VD sync signals) are detected for 30 or so seconds during PC signal input:

→ Power is turned off (standby); the power indicator lights up orange.

When pictures (HD/VD sync signals) are subsequently detected:

→ Power is turned on; the power indicator lights up green.

### Notes:

- This function operates only during PC signal input.
- This function is effective when "Sync" is set to "Auto", "Component / RGB-in select" is set to "RGB" and during normal viewing (one picture screen).

## Auto power off

Off ↔ On

Equipment power supply is turned Off when there is no signal.

When this is set to On, the power supply of the unit goes Off 10 minutes after the input signals stop.

## OSD design

Choose the background color (transparency).

→ Type1 ↔ Type2 ↔ Type3 ←

## OSD position

Choose the display position.

Each time you press ◀ or ▶, the on-screen menu display position changes.

Display example

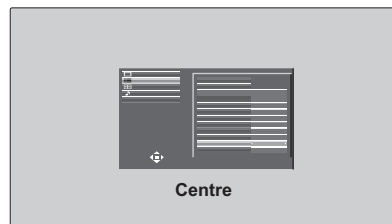
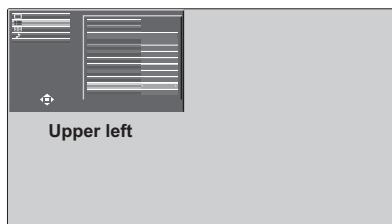

## OSD Language

Select your preferred language.

### ■ Selectable languages

- English(UK)
- Deutsch
- Français
- Italiano
- Español
- ENGLISH(US)
- 中文.....(Chinese)
- 日本語.....(Japanese)
- Русский.....(Russian)

# 3D Settings

If the 3D images are not displayed correctly or seem unusual, please adjust and setup the 3D settings.

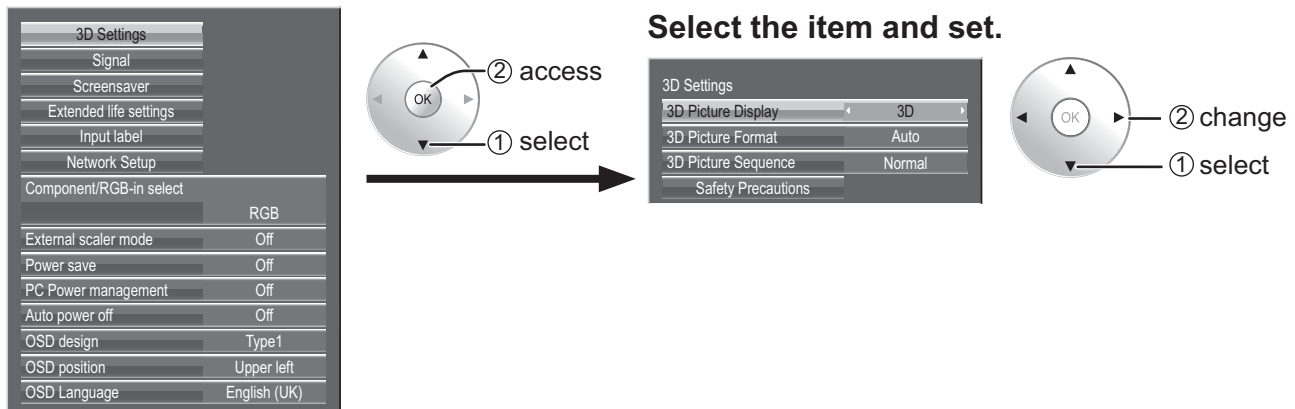

### • 3D Picture Display

**3D** ↔ **2D**

**3D:** Use of 3D Eyewear. You can see 3D images for 3D image signal and 2D images for 2D image signal.

**2D:** No use of 3D Eyewear. You can see 2D images instead of 3D images.

When set to "3D", "3D" is displayed during 3D images.

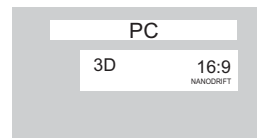

### • 3D Picture Format

3D images method is set.

**Auto:** 3D images are automatically displayed according to the signal.

**Side by Side/Top and Bottom:** One of the formats of the 3D standard. Select these formats as necessary.

**Native:** Displays the input signal as it is. Use to identify the format type of the input signal.

### • 3D Picture Sequence

**Reverse** ↔ **Normal**

This function calibrates the timing to switch the right and left images as well as the timing to switch the shutter of right and left 3D Eyewear.

Select "Reverse" if you feel that the sense of depth is unusual.

### • Safety Precautions

Displays the precautions for viewing 3D images.



# Signal menu

## Note:

“Signal” setup menu displays a different setting condition for each input signal.

**Select the item and set.**

② access  
① select

**For Video (S VIDEO)**

Signal [ AV ]  
3D Y/C Filter (NTSC) On  
Colour system Auto

**For Component**

Signal [ Component ]  
FRAME CREATION ON  
XGA Mode Auto  
H-Freq. 33.7 kHz  
V-Freq. 60.0 Hz  
Signal Format 1125(1080)/60i

**For RGB**

Signal [ RGB ]  
Sync Auto  
XGA Mode 1024 x768  
H-Freq. 33.7 kHz  
V-Freq. 60.0 Hz  
Signal Format 1125(1080)/60i

**For Digital (Example: HDMI input)**

Signal [ Digital ]  
24p SMOOTH FILM Off  
3D 24p Film Display 60Hz  
HDMI Range Auto  
H-Freq. 33.7 kHz  
V-Freq. 60.0 Hz  
Dot Clock Freq. 108.0 MHz  
Signal Format 1125(1080)/60i

**Input signal display**  
Displays the frequency and the type of the current input signal.  
This display is valid only for Component / RGB / PC and Digital input signal.  
Display range:  
Horizontal 15 - 110 kHz  
Vertical 48 - 120 Hz  
The dot clock frequency is displayed during digital signal input.

## • 3D Y/C Filter

This menu is displayed when BNC Dual Video Terminal Board (TY-FB9BD) is installed to the unit.

On ↔ Off

### Note:

When On, this setting only affects NTSC input signals.

## • Colour system

This menu is displayed when BNC Dual Video Terminal Board (TY-FB9BD) is installed to the unit.

→ Auto ↔ PAL ↔ SECAM ↔ M.NTSC ↔ NTSC ←

Set the colour system to match the input signal. When “Auto” is set, Colour system will be automatically selected from NTSC/PAL/SECAM /M.NTSC.

To display PAL60 signal, select “Auto” or “PAL”.

### If the picture image becomes unstable:

With the system set on Auto, under conditions of low level or noisy input signals the image may in rare cases become unstable. Should this occur, set the system to match the format of the input signal.

## • XGA Mode

This menu is displayed when the input signal is analog (Component/PC). This unit supports three types of XGA signals with 60Hz vertical frequency having different aspect ratios and sampling rates (1,024 × 768 @ 60Hz, 1,280 × 768 @ 60Hz and 1,366 × 768 @ 60Hz).

Auto ↔ 1024×768 ↔ 1280×768 ↔ 1366×768

**Auto:** Automatically selected from 1024×768/1280×768/1366×768.

Switch the setting to suit the input signal for better display depends on the angle of view or display resolution condition.

### Note:

After making this setting, be sure to make each adjustment (such as “Auto Setup”) on the “Pos. /Size” menu as necessary. (see page 25)

## Setup menu

---

### • Sync

This function operates only during input from PC IN terminal.

#### Setting RGB sync signal

Confirm that the input is set to RGB input (this setting is valid only for RGB input signal).

**Auto:** The H and V sync or synchronized signal is automatically selected. If both input, it is selected the H and V sync.



**on G:** Uses a synchronized signal on the Video G signal, which is input from the G connector.



**VBS:** Uses a synchronized signal of Composite Sync input, which is input from the HD connector.

#### Setting Component sync signal

Confirm that the input is set to Component input (this setting is valid only for Component input signal).

**Auto:** The H and V sync or synchronized signal is automatically selected. If both input, it is selected the H and V sync.



**on Y:** Uses a synchronized signal on the Video Y signal, which is input from the Y connector.

#### Note:

Accepts only RGB signals from COMPONENT/RGB IN terminal with "Sync on G".

### • SDI Through

Set the active through function of the Dual Link HD-SDI Terminal Board (TY-FB11DHD).

**Off** ↔ **On**

**On:** Enables active through.

**Off:** Disables active through.

#### Note:

Settings can only be performed for this menu when a slot mounted with a Dual Link HD-SDI Terminal Board (TY-FB11DHD) is selected.

### • FRAME CREATION

Displays reducing screen flicker image for 50Hz/25Hz signal input.

**Off** ↔ **On**

#### Note:

This function activates only for 50Hz/25Hz signal input with 2D images.

### • 24p SMOOTH FILM

During 2D or 3D viewing, images captured at 24 frames per second are provided in a smooth manner.

**Off** ↔ **On**

#### Note:

This function can be set only for 24p signal input with 2D or 3D images.

### • 3D 24p FILM DISPLAY

For 3D images, images captured at 24 frames per second are set.

**60Hz** ↔ **48Hz**

**60Hz:** Increases the number of frames to reproduce more natural movement images.

**48Hz:** Reproduces images like film-specific.

#### Note:

This function can be set only for 24p signal input with 3D images.

### • HDMI Range

Switches the dynamic range according to the input signal from HDMI 1 to HDMI 4 terminals.

**Video(16-235)** ↔ **Full(0-255)** ↔ **Auto**

**Video(16-235):** If the input signal is the video range, Example: HDMI terminal output for DVD player

**Full(0-255):** If the input signal is full range, Example: HDMI terminal output for personal computer

**Auto:** Switches the dynamic range automatically between "Video(16-235)" and "Full(0-255)" according to the input signal.

#### Note:

This function can be set only for HDMI 1 to HDMI 4 terminal input.

# Screensaver

Do not display a still picture, especially in 4:3 mode, for any length of time.  
If the display must remain on, a Screensaver should be used.

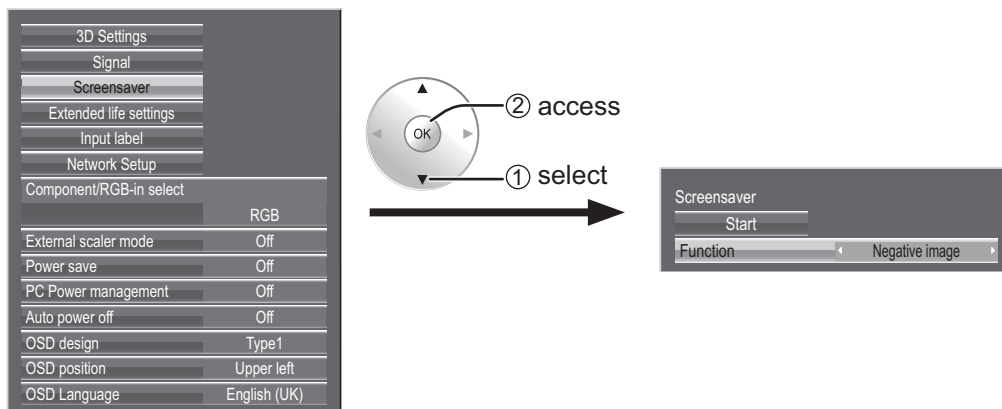

## 1 Function selection

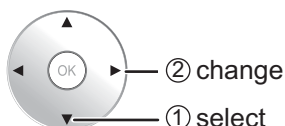

⇨ **Negative image** ⇨ ⇩ **Scrolling bar only** ⇨ ⇩  
 ⇨ **White screen** ⇨ ⇩ **Overlay scrolling bar** ⇨ ⇩

**Negative image** : Negative image will be displayed on the screen.  
**Scrolling bar only** : A white bar will scroll from left to right. The image won't be displayed.

**Overlay scrolling bar** : The brightness of the image will be decreased and a white bar will scroll on it.

**White screen** : The whole screen will be white.

## 2 Start setting

Select "Start".

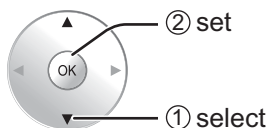

The menu screen will disappear and the Screensaver will be activated. **To stop the Screensaver under On, press any button.**

**Note:** When the display is turned off, the Screensaver will be deactivated.

## Extended life settings

The following settings are setup to reduce image retention:

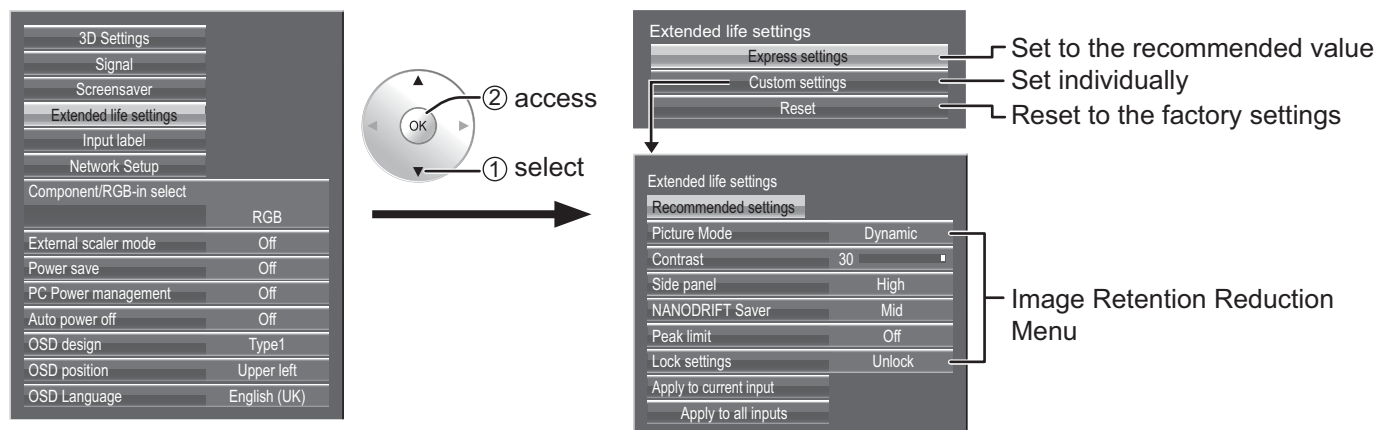

### Image Retention Reduction Menu

“Extended life settings” enables you to set the following 5 menus (Image Retention Reduction Menu) as recommended values or set them individually.

#### Picture Mode

##### Contrast

“Picture Mode” and “Contrast” are same as “Picture” menu items (see page 29). The settings of this menu will be reflected to the “Picture” menu.

#### Side panel

Do not display a picture in 4:3 mode for an extended period, as this can cause an image retention to remain on the side panels on either side of the display field.

To reduce the risk of such an image retention, illuminate the side panels.

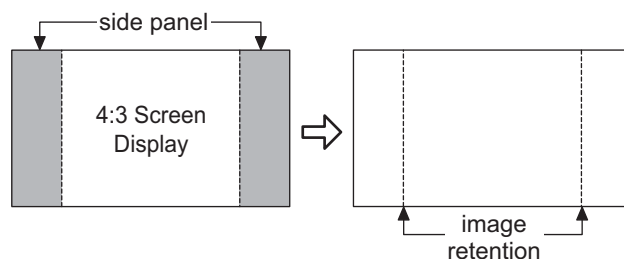

This function may be applicable to the non-picture area.

**Off:** Darken both ends.

**Low:** Make it dark gray.

**Mid:** Make it gray.

**High:** Make it light gray.

#### Notes:

- To reduce the occurrence of image retention, set the Side panel to High.
- The side panel may flash (alternate black/white) depending on the picture being shown on the screen. Using Cinema mode will reduce such flashing.

## NANODRIFT Saver

Moves the display position of the screen slightly to reduce image retention on the display panel.

**Low–High:** NANODRIFT Saver operates. The display position of the screen moves at set time intervals. You can set the screen movement range. Some of the screen may appear to be missing as a result of this operation. If you change the value, a mask is displayed in the range where the picture is missing as a result of position movement.

When “NANODRIFT” Image Retention Reduction is operating, “NANODRIFT” is displayed.

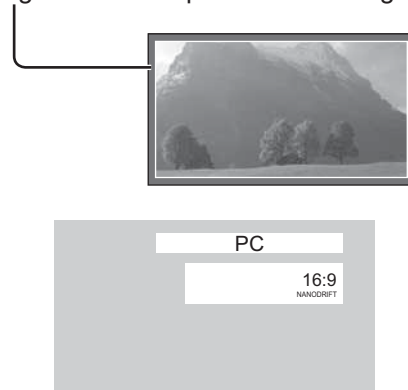

## Peak limit

**On:** Suppresses image contrast (peak brightness).

**Note:** When a still picture is viewed for an extended time, the screen may become slightly darker. (see page 60)

### Extended life settings when profile is locked

If profile is locked with “Memory lock” of the Options menu, the operations of this settings menu are restricted as shown below. “Locking profiles” ➔ page 38

Express settings: Cannot be set.

Custom settings: “Picture Mode”, “Contrast” and “Lock settings” cannot be set.

Reset: “Picture Mode” and “Contrast” are not reset.

## Express settings

Set the “Image Retention Reduction” menu to the recommended settings.

All menus will be locked.

Picture Mode: Normal

Contrast: Recommended setting for each model

Side panel: High

NANODRIFT Saver: Mid

Peak limit: On

### 1 Select “Express settings”.



### 2 Select the input to apply the settings.

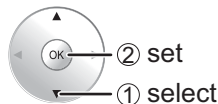
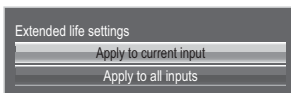

### 3 Select “Yes”.

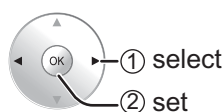
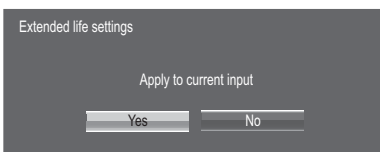

# Setup menu

## Custom settings

Set the individual "Image Retention Reduction" menu.

**1** Select "Custom settings".

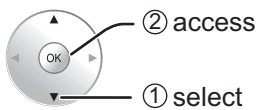

**2** To set each menu to the recommended setting:  
Select "Recommended settings".

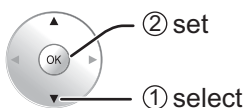
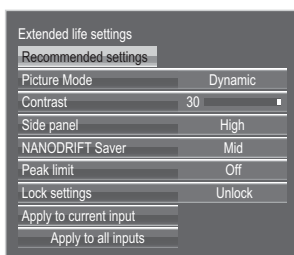

Each menu will be set as same as the "Express settings".

**3** Set each menu.

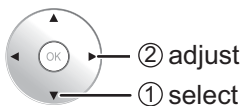
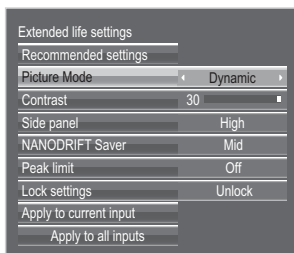

**4** To lock each menu setting:  
Set the "Lock settings" to "Lock".

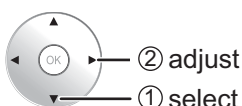
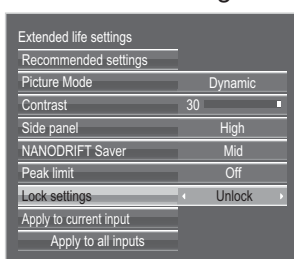

## Reset

Reset the "Image Retention Reduction" menu to the factory settings. Each menu will be unlocked.

**1** Select "Reset".

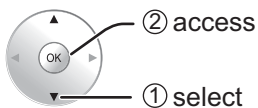
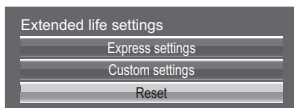

**2** Select the input to reset the settings.

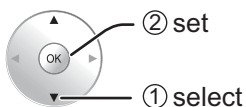
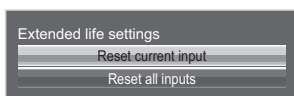

When a menu is locked, it is grayed out and cannot be set.

"Picture Mode" and "Contrast" will no longer be able to set in the "Picture" menu, and they are labeled with icon to indicate their locked status. Also, "Normalise", "Memory save" and "Memory load" are not available.

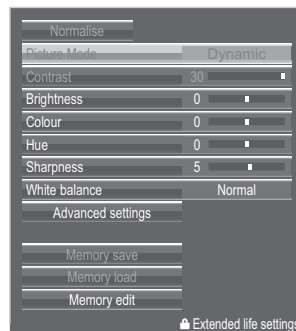

**5** Select the input to apply the settings.

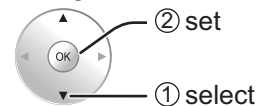
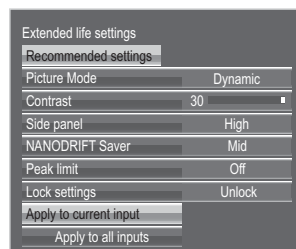

**6** Select "Yes".

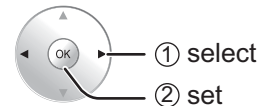
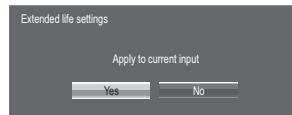

# Customizing the Input labels

This function can change the label of the Input signal to be displayed. (see page 16)

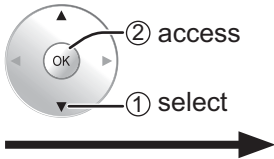
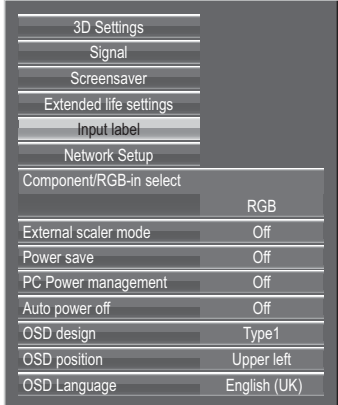

### Select an input terminal and set.

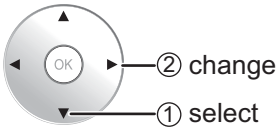
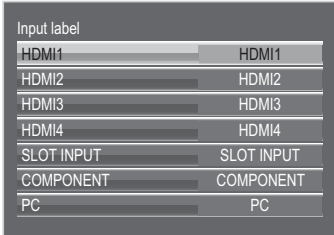

**Note:**  
The setting items are the same as the input terminal list of "Selecting the input signal" (page 16).

The input label changes as follows each time the ◀ or ▶ button is pressed.



(Skip) : The INPUT button press will skip its input.

## Network Setup

Make the various settings to use the network function.

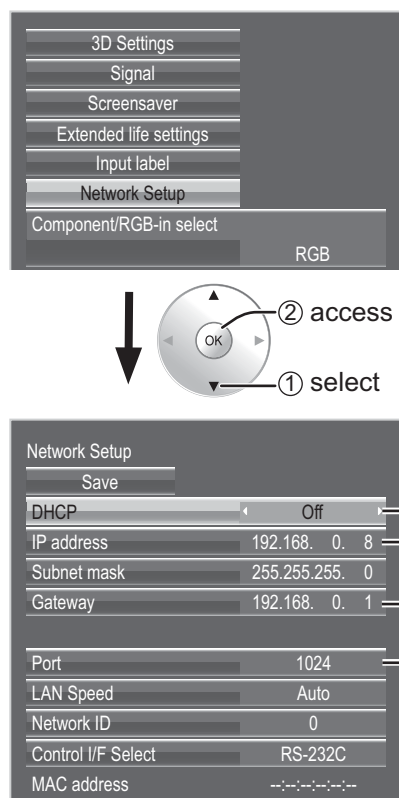

### DHCP, IP address, Subnet mask and Gateway settings

- 1** Set DHCP.  
When "Off" is selected, IP address and other settings can be set manually.
- 2** Select the item and press **OK**.
- 3** Enter an address.  
IP address: 192.168. 0. 8
  - ① Use **◀▶** to select a digit.
  - ② Use **▲▼** to change a number or input the numerical value from **0** to **9**.
  - ③ Press **OK**.
 Pressing **RETURN** will cancel the address change.
- 4** Select "Save" and press **OK**.

### Port setting

- 1** Select "Port" and press **OK**.
- 2** Enter a port number.  
Port: 1024
  - ① Use **◀▶** to select a digit.
  - ② Use **▲▼** to change a number or input the numerical value from **0** to **9**.
  - ③ Press **OK**.
 Pressing **RETURN** will cancel the port number change.

### Save

Save the current network Setup. Each value set for DHCP, IP address, Subnet mask, and Gateway will be saved. If "NG" is displayed, check the same IP address is not used within the same network.

### DHCP (DHCP client function)

To obtain an IP address automatically using a DHCP server, set this to "On". If DHCP server is not used, set this to "Off".

### IP address (IP address display and setting)

Enter an IP address if DHCP server is not used.

### Subnet mask (Subnet mask display and setting)

Enter a subnet mask if DHCP server is not used.

### Gateway (Gateway address display and setting)

Enter a gateway address if DHCP server is not used.

### Port

Set the port number used for command control. The available setting range is 1024 – 65535. When the PLink™ protocol is used, the port setting is not necessary.

### LAN Speed

Set the connection speed of the LAN environment. Select the value from Auto, 10 Half, 10 Full, 100 Half or 100 Full.

### Network ID

Set the ID to identify this unit. The available setting range is 0 – 99.

### Control I/F Select

Set whether to control with RS-232C (serial) or LAN. When "LAN" is set, power is supplied to LAN circuit, and power indicator is lit orange under the condition of power "Off" with remote control (stand-by state).

### MAC address

Display the MAC address of this unit. However, the MAC address is not displayed when the "Control I/F Select" is set to "RS-232C".

### Notes:

- To use a DHCP server, make sure the DHCP server is started.
- Contact your network administrator for details on settings.



# Options Adjustments

1 Display the menu screen.



2 Select "Options".

3 Press for more than 3 seconds.

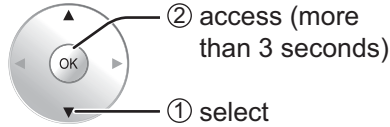
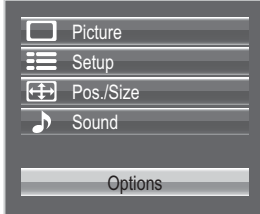

4 Select the item and set.

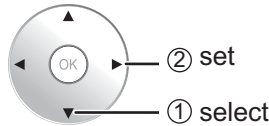
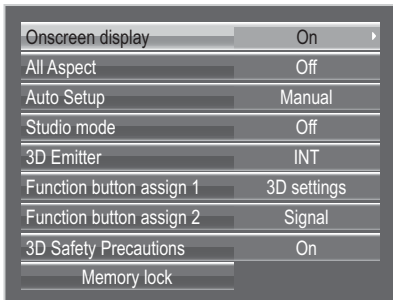

5 Exit the menu.



Item	Adjustments												
<b>Onscreen display</b>	<p><b>On:</b> Displays all the following on screen.</p> <ul style="list-style-type: none"> <li>• Power on display</li> <li>• Input signal switch display</li> <li>• No signal display</li> <li>• Remaining time of off-timer after  was pressed.</li> </ul> <p><b>Off:</b> Hides all the items above from view.</p>												
<b>All Aspect</b>	<p>Sets All Aspect mode (advanced aspect setting) or default aspect mode.</p> <p>With each press of  button, the aspect changes in the selected mode.</p> <p><b>Off:</b> Default aspect mode  <b>On:</b> All Aspect mode</p> <p>Aspect mode of each setting is as follows:            (Example: HD signal)  <b>Off</b> 4:3→4:3 Full→Zoom1→Zoom2→Zoom3→16:9→14:9→Just  <b>On</b> 4:3 (1)→4:3 (2)→4:3 Full→Zoom1→Zoom2→Zoom3→16:9→14:9→Just1→Just2</p>												
<b>Auto Setup</b>	<p>Sets the operational mode of the automatic position adjustment in the Pos./Size menu.</p> <p><b>Manual:</b> Automatic position adjustment starts when  is pressed on the remote control or automatic position adjustment is executed from the Pos./Size menu.</p> <p><b>Auto:</b> Other than remote control or menu operation, automatic position adjustment starts:            When the display power is turned ON.            When the input signal is switched.</p>												
<b>Studio mode</b>	<p>For switching functions in setting menus used for television studio applications.</p> <table border="1"> <thead> <tr> <th></th> <th>Studio mode: On</th> <th>Studio mode: Off</th> </tr> </thead> <tbody> <tr> <td><b>White balance</b></td> <td>"Studio" can be selected.</td> <td>"Studio" not available.</td> </tr> <tr> <td><b>Studio Gain</b></td> <td>Can be switched On and Off.</td> <td>Cannot be specified (set to "Off" and cannot be changed).</td> </tr> <tr> <td><b>Under scan</b></td> <td>Can be switched On and Off.</td> <td>Cannot be specified (set to "Off" and cannot be changed).</td> </tr> </tbody> </table>		Studio mode: On	Studio mode: Off	<b>White balance</b>	"Studio" can be selected.	"Studio" not available.	<b>Studio Gain</b>	Can be switched On and Off.	Cannot be specified (set to "Off" and cannot be changed).	<b>Under scan</b>	Can be switched On and Off.	Cannot be specified (set to "Off" and cannot be changed).
	Studio mode: On	Studio mode: Off											
<b>White balance</b>	"Studio" can be selected.	"Studio" not available.											
<b>Studio Gain</b>	Can be switched On and Off.	Cannot be specified (set to "Off" and cannot be changed).											
<b>Under scan</b>	Can be switched On and Off.	Cannot be specified (set to "Off" and cannot be changed).											

# Options Adjustments

Item	Adjustments
3D Emitter	Set the infrared transmitter for the 3D Eyewear. <b>INT:</b> Use the infrared transmitter of the unit. <b>EXT:</b> Use the external 3D IR TRANSMITTER (available separately.)
Function button assign 1 Function button assign 2	Set the function to operate when the FUNCTION button 1 to 2 on the remote control is pressed. <b>3D settings:</b> The "3D Settings" menu is displayed. <b>Scrolling bar:</b> The screen saver activates, and after 15 minutes, the display power shuts down (standby). <b>Test patterns:</b> The test pattern is displayed by switching among seven patterns. <b>Blue only:</b> The screen displays only blue color for image adjustment. <b>Signal:</b> The "Signal" menu is displayed.
3D Safety Precautions	3D Safety Precautions show/hide is set during power ON. <b>On:</b> 3D Safety Precaution is shown every time when the power is ON. <b>Off:</b> 3D Safety Precaution is not shown when the power is ON. When the setting changes from "On" to "Off", the confirmation screen is displayed as below. Pressing "YES" switches the setting.
Memory lock	Locks or unlocks saved profiles. Also for setting passwords. (see page 38)

## Using FUNCTION button

Pressing the FUNCTION button activates one of the following five functions. The settings of functions are performed with the "Function button assign 1" and "Function button assign 2" on the Options menu. (see above)

The factory preset functions are as described below.

FUNCTION 1 Button: 3D Settings

FUNCTION 2 Button: Signal

### 3D Settings / Signal

The menu screen is displayed.  
(Example: 3D Settings)

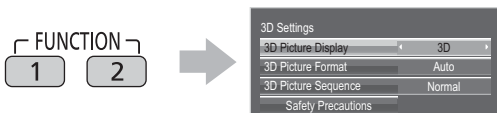

Pressing the FUNCTION button clears the menu.



### Scrolling bar / Test patterns / Blue only

Confirmation screen (Example: Scrolling bar)

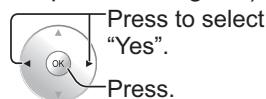

The operation starts.

#### Scrolling bar

Activates the "Scrolling bar only" screensaver. After 15 minutes, the display enters standby mode.



To exit this mode, press any button.

#### Blue only

The screen displays only blue color for image adjustment.

To exit this mode, press FUNCTION button.

#### Note:

"PC Power management" and "Auto power off" are deactivated during "Scrolling bar" or "Test patterns" operation. (see page 43)

#### Test patterns

Each time you press , a different test pattern is displayed (seven in all).

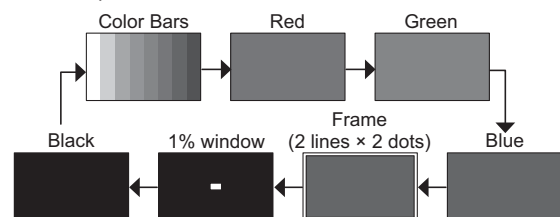

To exit this mode, press any button other than .

# Using Network Function

This unit has a network function to control the network connected display with your computer.

**Note:**

To use the network function, set each "Network Setup" setting and make sure to set the "Control I/F Select" to "LAN". (see page 52)

When "LAN" is set, power is supplied to LAN circuit, and power indicator is lit orange under the condition of power "Off" with remote control (stand-by state).

## Example of Network Connection

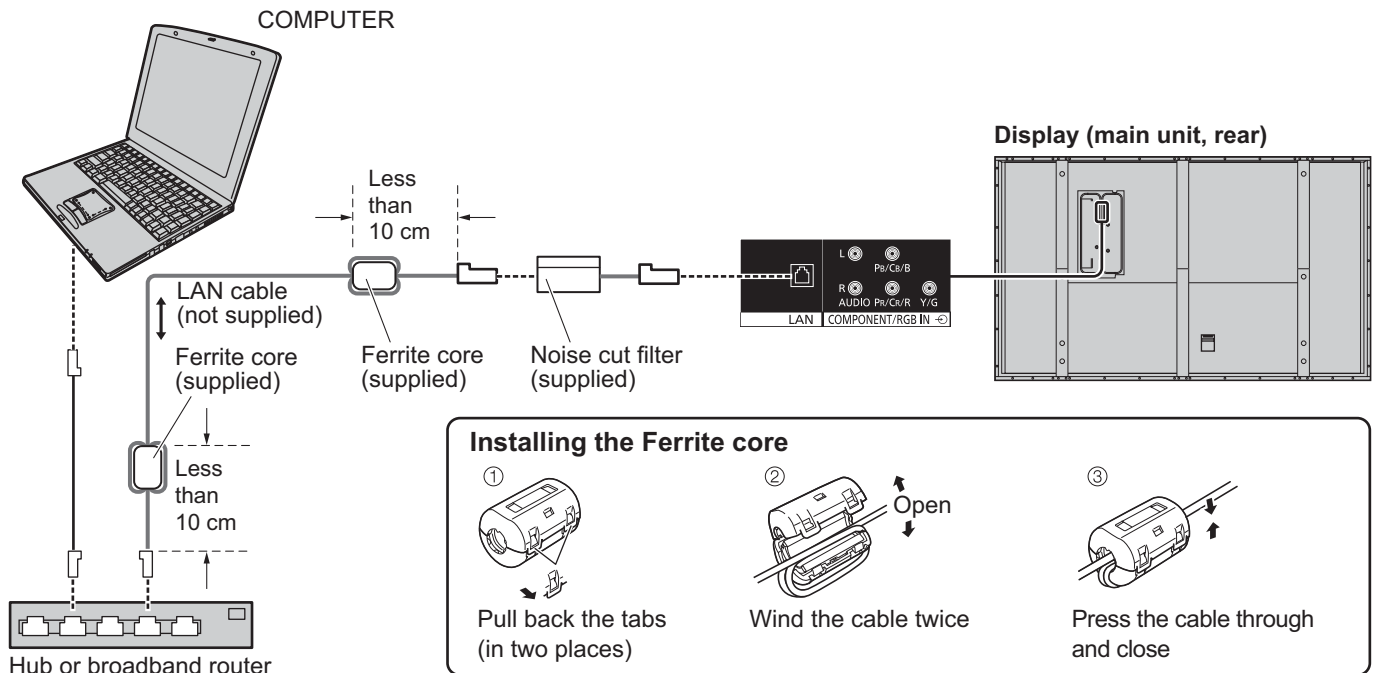

**Notes:**

- Lay the LAN cable away from other connection cables (excluding the power cord).
- Make sure the broadband router or hub supports 10BASE-T/100BASE-TX.
- To connect a device using 100BASE-TX, use "category 5" LAN cable.
- Touching the LAN terminal with a statically charged hand (body) may cause damage due to its discharge. Do not touch the LAN terminal or a metal part of the LAN cable.
- For instructions on how to connect, consult your network administrator.

**Securing the LAN cable (TH-85VX200W)**

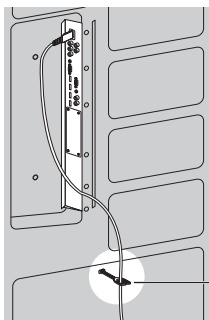

When using a pedestal (TY-ST85P12) for the installation of the display, use a clammer supplied with the display to secure the LAN cable. For use with another method of installation, refer to the corresponding Installation Instructions.

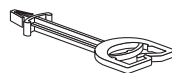

**Note:** In accordance with the Installation Instructions, secure the LAN cable so that it will not become near the display unit.

## Command Control

Network function of the unit can control the unit in the same way as serial control from a network.

**Supported commands**

Commands used in the serial control are supported. (see page 13)

**Note:**

Consult your local Panasonic dealer for detail instructions on command usage.

# PJLink™ Protocol

The network function of the unit conforms with PJLink™ class 1 and you can operate the following actions from your computer using PJLink™ protocol.

- Display setup
- Display status query

### Supported commands

Commands to control the unit with PJLink™ protocol are shown in the table below.

Command	Control	Remark
POWR	Power control	Parameter 0 = Standby 1 = Power "On"
POWR?	Power status query	Parameter 0 = Standby 1 = Power "On"
INPT	Input switch	Parameter See the parameter for command INST?
INPT?	Input switch query	
AVMT	Shutter control	Parameter 10 = Picture On (picture mute deactivated), 11 = Picture Off (picture on mute) 20 = Audio On (audio mute deactivated), 21 = Audio Off (audio on mute) 30 = Shutter mode Off (picture and audio mute deactivated) 31 = Shutter mode On (picture and audio on mute)
AVMT?	Shutter control query	Parameter 11 = Picture Off (picture on mute) 21 = Audio Off (audio on mute) 30 = Shutter mode Off (picture and audio mute deactivated) 31 = Shutter mode On (picture and audio on mute)
ERST?	Error status query	Parameter First byte: Means fan error. 0 or 2. Second byte: 0 Third byte: 0 Fourth byte: 0 Fifth byte: 0 Sixth byte: Means other error. 0 or 2. Meaning of the 0 – 2 settings: 0 = Error is not detected, 2 = Error
LAMP?	Lamp status query	Not supported
INST?	Input switch list query	Parameter Numbers 11 to 13 are depending on the slot installation condition 11: PC IN input (PC) When a single input terminal board is attached 11: SLOT input (SLOT INPUT) 12: PC IN input (PC)  21: COMPONENT/RGB IN input (COMPONENT) 31: HDMI 1 input (HDMI1) 33: HDMI 3 input (HDMI3)  When a dual input terminal board is attached 11: SLOT input (SLOT INPUT A) 12: SLOT input (SLOT INPUT B) 13: PC IN input (PC)  32: HDMI 2 input (HDMI2) 34: HDMI 4 input (HDMI4)
NAME?	Projector name query	Returns empty character (no name information)
INF1?	Manufacturer name query	Returns "Panasonic"
INF2?	Model name query	Returns "TH-103VX200" (for 103-inch model)
INFO?	Other information query	Returns version number
CLSS?	Class information query	Returns "1"

### PJLink™ security authentication

Set "Panasonic" for the PJLink™ password.

- PJLink™ is a pending trademark in Japan, the United States, and other countries or areas.

# Using Web Browser Control

You can use a Web browser to control the unit and set up a network and password.

## Before Using Web Browser Control

To use the Web browser control, the unit and computer setups are required.

### Unit Setup

Set each “Network Setup” setting and make sure to set the “Control I/F Select” to “LAN”. (see page 52)

### Computer Setup

Disable the proxy server settings and enable JavaScript.

#### (Windows)

##### Disable proxy server settings

- 1 Display [Internet Properties] window.  
Click [Start] – [Control Panel] – [Network and Internet Connections] – [Internet Options].
- 2 Click the [Connections] tab and then [LAN Settings].
- 3 Deselect the [Use automatic configuration script] and [Use a proxy server for your LAN] boxes.
- 4 Click [OK].

##### Enable JavaScript

- 1 Display [Internet Properties] window.  
Click [Start] – [Control Panel] – [Network and Internet Connections] – [Internet Options].
- 2 Set the security level on the [Security] tab to [Default Level]. Alternatively enable [Active scripting] from the [Custom Level] button.

#### (Macintosh)

##### Disable proxy server settings

- 1 From the [Safari] menu, click [Preferences].  
General screen is displayed.
- 2 From the [Advanced] tab, click the [Change Settings...] button next to [Proxies]. Click [Proxies] and set up a proxy server.
- 3 Deselect the [Web Proxy] and [Automatic Proxy Configuration] boxes.
- 4 Click [Apply Now].

##### Enable JavaScript

- 1 Display [Security] of Safari.
- 2 Select [Enable JavaScript] under [Web content].

## Access from Web Browser

Access to the TOP screen of the Web browser control using a Web browser.

- 1 Start your Web browser.
- 2 Enter the IP address set with the “Network Setup” of the unit. (see page 52)

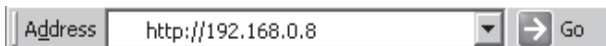

- 3 Enter the user name and password when the Authentication screen is displayed.

### Authentication screen



- 4 Click [OK].  
After logged in, the TOP screen of the Web browser control is displayed. (see page 58)

### Notes:

- The password used here is the same password used for command control and the PJLink™ security authentication.
- Default user name and password are as follows:  
User name: user1  
Password: Panasonic
- The password can be changed on the Password Setup screen after logging in (see page 59). The user name cannot be changed.
- Under no circumstances, Panasonic Corporation or its associated companies will ask customers their password directly.  
Even if you are asked directly, please do not reveal your password.

# Using Web Browser Control

## TOP screen structure of the Web browser control

After logging in, the TOP screen of the Web browser control is displayed.

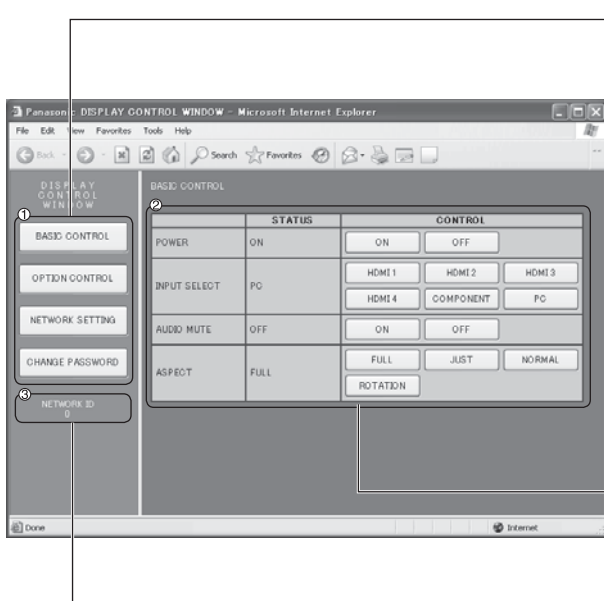

① **Menu**

Menu items are displayed. When a button is clicked, setup screen of each item is displayed.

Item	Details
BASIC CONTROL	BASIC CONTROL screen is displayed. (see below)
OPTION CONTROL	OPTION CONTROL screen is displayed. (see below)
NETWORK SETTING	Network Setup screen is displayed. (see page 59)
CHANGE PASSWORD	Password setup screen is displayed. (see page 59)

② According to the selected item from the main menu, setup status or set items are displayed.

③ **Network ID information**

ID to identify the unit is displayed.

## Display Control (BASIC CONTROL/OPTION CONTROL Screen)

Click BASIC CONTROL or OPTION CONTROL from the menu. Various controls of the unit can be set.

### BASIC CONTROL screen

Click BASIC CONTROL from the menu. Unit status and buttons to change settings are displayed.

	STATUS	CONTROL
POWER	ON	<input type="button" value="ON"/> <input type="button" value="OFF"/>
INPUT SELECT	PC	<input type="button" value="HDMI 1"/> <input type="button" value="HDMI 2"/> <input type="button" value="HDMI 3"/> <input type="button" value="HDMI 4"/> <input type="button" value="COMPONENT"/> <input type="button" value="PC"/>
AUDIO MUTE	OFF	<input type="button" value="ON"/> <input type="button" value="OFF"/>
ASPECT	FULL	<input type="button" value="FULL"/> <input type="button" value="JUST"/> <input type="button" value="NORMAL"/> <input type="button" value="ROTATION"/>

Item	Details
POWER	Switch ON/OFF of the unit power.
INPUT SELECT	Switch the input signals. Displayed buttons vary according to the connection status of the video device.
AUDIO MUTE	Switch ON/OFF of the sound mute.
ASPECT	Switch the screen modes

### OPTION CONTROL screen

Click OPTION CONTROL from the menu. Command input field for command control of the unit is displayed.



Item	Details
COMMAND	Enter a command. Use the same command used for the serial control. (see page 13)
RESPONSE	Response from the unit is displayed.
SEND	Command is sent and run.

**Note:**

After the settings are changed, it may take a while till the display status is displayed.

## NETWORK SETTING (Network Setup Screen)

Click NETWORK SETTING from the menu. Various settings of a network can be set. For the details of the setting items, please check Network Setup under the Set up of the unit. (see page 52)

DHCP	<input type="radio"/> OFF <input type="radio"/> ON
IP ADDRESS	192.168.0.8
SUBNET MASK	255.255.255.0
GATEWAY	192.168.0.1
PORT	1024
LAN SPEED	<input type="radio"/> AUTO <input type="radio"/> 10 HALF <input type="radio"/> 10 FULL <input type="radio"/> 100 HALF <input type="radio"/> 100 FULL
NETWORK ID	0
<input type="button" value="SAVE"/>	

**Notes:**

- To use a DHCP server, make sure the DHCP server is started.
- During a DHCP server is used, IP ADDRESS, SUBNET MASK, and GATEWAY values cannot be entered.
- When the set values are changed properly, "NETWORK SETTING CHANGED." message and the changed set items are displayed.

Item	Details
DHCP	Set to ON when a DHCP server is used, or OFF when it is not used.
IP ADDRESS	Enter an IP address.
SUBNET MASK	Enter a subnet mask.
GATEWAY	Enter a gateway address.
PORT	Enter the port number used for command control. The available setting range is 1024 - 65535.
LAN SPEED	Set the connection speed of the LAN environment.
NETWORK ID	Set the ID to identify this unit. The available setting range is 0 - 99.
SAVE	Save the each set value.

## Password Setting (Password Setup Screen)

Click CHANGE PASSWORD from the menu. Password to access the Web browser control can be set. When the password is changed in this screen, the password used for command control and the PJLink™ security authentication is also changed.

OLD PASSWORD	*****
NEW PASSWORD	*****
NEW PASSWORD (RETYPE)	*****
<input type="button" value="SAVE"/>	

**Notes:**









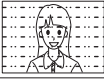

- The default password is "Panasonic".
- Up to 32 alphanumeric characters can be used for a password.
- When the password is changed properly, "Password has changed." message is displayed.

Item	Details
OLD PASSWORD	Enter the old password.
NEW PASSWORD	Enter the new password.
NEW PASSWORD (RETYPE)	Enter the password entered in "NEW PASSWORD" for confirmation.
SAVE	Save the new password. The confirmation screen is displayed. Click OK to change the password.



# Troubleshooting

Before you call for service, determine the symptoms and make a few simple checks as shown below.



Symptoms		Checks
Picture	Sound	
 Interference	 Noisy Sound	Electrical Appliances Cars / Motorcycles Fluorescent light
 Normal Picture	 No Sound	Volume (Check whether the mute function has been activated on the remote control.)
 No Picture	 No Sound	Not plugged into AC outlet Not switched on Picture and Brightness/Volume setting (Check by pressing the power switch or stand-by button on the remote control.)
 No Picture	 Normal Sound	If a signal with a non-applicable colour system format, or frequency is input, only the input terminal indication is displayed.
 No Colour	 Normal Sound	Colour controls set at minimum level (see page 28-33) Colour system (see page 45)
No remote control operations can be performed.		Check whether the batteries have discharged completely and, if they have not, whether they were inserted properly. Check whether the remote control sensor is exposed to an outdoor light or a strong fluorescent light. Check whether the remote control designed specifically for use with the unit is being used. (The unit cannot be operated by any other remote control.)
A cracking sound is sometimes heard from the unit.		If there is nothing wrong with the picture or sound, this is the sound of the cabinet undergoing very slight contractions in response to changes in the room temperature. There are no adverse effects on the performance or other aspects.
The top or bottom of the picture on the screen is cut off when I use the zoom function.		Adjust the position of the picture on the screen.
Areas at the top and bottom of the screen where the image is missing appear when I use the zoom function.		When using a video software program (such as a cinema size program) with a screen wider than one in the 16:9 mode, blank areas separate from the images are formed at the top and bottom of the screen.
I can hear sounds coming from inside the unit.		When the power is turned on, a sound of the display panel being driven may be heard: This is normal and not indicative of malfunctioning.
Parts of the unit become hot.		Even when the temperature of parts of the front, top and rear panels has risen, these temperature rises will not pose any problems in terms of performance or quality.
Power automatically turns off unexpectedly.		Check the settings of "PC Power management" and "Auto power off" in the Setup menu. Any of them may be set to "On". (see page 43)
Power indicator is blinking in red.		There is possibility of malfunction. Please contact an Authorized Service Center.
This Plasma Display uses special image processing. Hence a slight time lag may occur between image and audio, depending on the type of input signal. However, this is not a malfunction.		

## Plasma Display panel

Symptoms	Check
The screen darkens slightly when bright pictures with minimal movements are shown.	The screen will darken slightly when photos, still images of a computer or other pictures with minimal movements are shown for an extended period. This is done to reduce image retention on the screen and the shortening of the screen's service life: It is normal and not indicative of malfunctioning.
It takes a while for the picture to appear.	The unit digitally processes the various signals in order to reproduce esthetically pleasing images. As such, it sometimes takes a few moments for the picture to appear when the power has been turned on, when the input has been switched or when the images for the main picture and sub picture on the two screens are swapped.
The edges of the images flicker.	Due to the characteristics of the system used to drive the panel, the edges may appear to flicker in the fast-moving parts of the images: This is normal and not indicative of malfunctioning.
The brightness on both sides of images in the 4:3 mode changes.	When viewing the side panels at the "High" or "Mid" setting, the brightness on both sides may change depending on the kind of program shown: This is normal and not indicative of malfunctioning.
Some parts of the screen do not light up.	The plasma display panel is manufactured using an extremely high level of precision technology, however, sometimes some parts of the screen may be missing picture elements or have luminous spots. This is not a malfunction.
 Image retention appears	Do not allow a still picture to be displayed for an extended period, as this can cause a permanent image retention to remain on the Plasma Display. Examples of still pictures include logos, video games, computer images, teletext and images displayed in 4:3 mode. <b>Note:</b> The permanent image retention on the Plasma Display resulting from fixed image use is not an operating defect and as such is not covered by the Warranty. This product is not designed to display fixed images for extended periods of time.
Whirring sounds can be heard from the display unit.	The display unit is fitted with a cooling fan to dissipate heat generated during normal use. The whirring sound is caused by rotation of the fan and is not a malfunction.

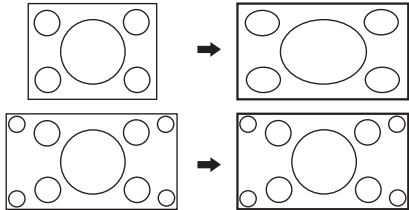
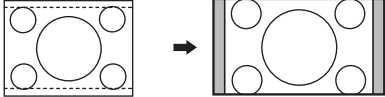
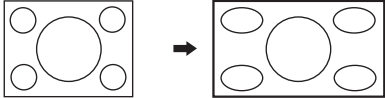
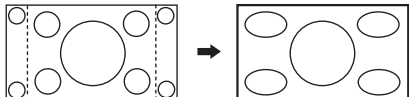
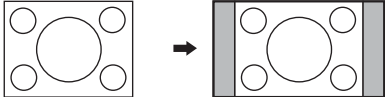
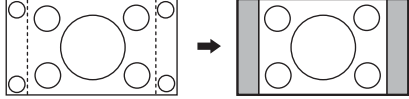
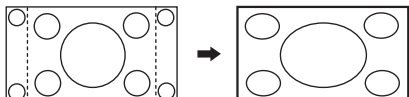
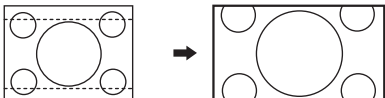
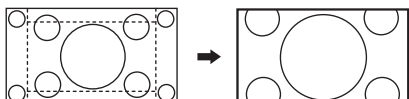

# List of Aspect Modes

Aspect mode		Picture → Enlarged screen	Description
All Aspect: On	Factory setting All Aspect: Off		
16:9	16:9		The display of the pictures fills the screen. In the case of SD signals, pictures with a 4:3 aspect ratio are enlarged horizontally, and displayed. This mode is suited to displaying anamorphic pictures with a 16:9 aspect ratio.
14:9	14:9		Letterbox pictures with a 14:9 aspect ratio are enlarged vertically and horizontally so that their display fills the screen vertically and is slightly smaller than the screen horizontally. The top and bottom edges of the pictures are cut off. Side panels are displayed at the left and right edges of the screen.
Just ----- Just1	Just		Pictures with a 4:3 aspect ratio are enlarged horizontally so that the picture distortion is minimized. The display of the areas around the left and right edges of the screen is slightly elongated.
Just2	–		The pictures with a 4:3 aspect ratio among the 16:9 aspect ratio signals are enlarged horizontally so that the picture distortion is minimized. The left and right edges of the pictures are cut off. The display of the areas around the left and right edges of the screen is slightly elongated.
4:3 ----- 4:3 (1)	4:3		Pictures with a 4:3 aspect ratio are displayed with their original aspect ratio. Side panels are displayed at the left and right edges of the screen.
4:3 (2)	–		The pictures with a 4:3 aspect ratio among the 16:9 aspect ratio signals are displayed with their original aspect ratio. The left and right edges of the pictures are masked with side panels.
4:3 Full	4:3 Full		The pictures with a 4:3 aspect ratio among the 16:9 aspect ratio signals are enlarged horizontally so that their display fills the screen. The left and right edges of the pictures are cut off.
Zoom ----- Zoom1	Zoom1		Letterbox pictures with a 16:9 aspect ratio are enlarged vertically and horizontally so that their display fills the screen. The top and bottom edges of the pictures are cut off.
Zoom2	Zoom2		The letterbox pictures with a 2.35:1 aspect ratio among the 16:9 aspect ratio signals are enlarged vertically and horizontally so that their display fills the screen. The top and bottom edges as well as the left and right edges of the pictures are cut off.
Zoom3	Zoom3		Letterbox pictures with a 2.35:1 aspect ratio are enlarged vertically and horizontally so that their display fills the screen vertically and is slightly larger than the screen horizontally. The top and bottom edges as well as the left and right edges of the pictures are cut off.

# Applicable Input Signals

\*Mark: Applicable input signal

	Signal name	Horizontal frequency (kHz)	Vertical frequency (Hz)	COMPONENT / RGB IN / PC IN (Dot clock (MHz))	HDMI 1-4
1	525 (480) / 60i	15.73	59.94	* (13.5)	*
2	525 (480) / 60p	31.47	59.94	* (27.0) *5	*
3	625 (575) / 50i	15.63	50.00	* (13.5)	
4	625 (576) / 50i	15.63	50.00		*
5	625 (575) / 50p	31.25	50.00	* (27.0)	
6	625 (576) / 50p	31.25	50.00		*
7	750 (720) / 60p	45.00	60.00	* (74.25)	*
8	750 (720) / 50p	37.50	50.00	* (74.25)	*
9	1,125 (1,080) / 60p	67.50	60.00	* (148.5) *1	*
10	1,125 (1,080) / 60i	33.75	60.00	* (74.25) *1	*
11	1,125 (1,080) / 50p	56.26	50.00	* (148.5) *1	*
12	1,125 (1,080) / 50i	28.13	50.00	* (74.25) *1	*
13	1,125 (1,080) / 24sF	27.00	48.00	* (74.25) *2	
14	1,125 (1,080) / 30p	33.75	30.00	* (74.25) *1	
15	1,125 (1,080) / 25p	28.13	25.00	* (74.25) *1	
16	1,125 (1,080) / 24p	27.00	24.00	* (74.25) *1	*
17	1,250 (1,080) / 50i	31.25	50.00	* (74.25) *3	
18	2,048 × 1,080 / 24sF *7	27.00	48.00		
19	2,048 × 1,080 / 24p *7	27.00	24.00		
20	640 × 400 @70 Hz	31.46	70.07	* (25.17)	
21	640 × 480 @60 Hz	31.47	59.94	* (25.18) *6	*
22	640 × 480 @72 Hz	37.86	72.81	* (31.5)	
23	640 × 480 @75 Hz	37.50	75.00	* (31.5)	
24	640 × 480 @85 Hz	43.27	85.01	* (36.0)	
25	800 × 600 @56 Hz	35.16	56.25	* (36.0)	
26	800 × 600 @60 Hz	37.88	60.32	* (40.0)	*
27	800 × 600 @72 Hz	48.08	72.19	* (50.0)	
28	800 × 600 @75 Hz	46.88	75.00	* (49.5)	
29	800 × 600 @85 Hz	53.67	85.06	* (56.25)	
30	852 × 480 @60 Hz	31.47	59.94	* (33.54) *6	
31	1,024 × 768 @50 Hz	39.55	50.00		
32	1,024 × 768 @60 Hz	48.36	60.00	* (65.0)	*
33	1,024 × 768 @70 Hz	56.48	70.07	* (75.0)	
34	1,024 × 768 @75 Hz	60.02	75.03	* (78.75)	
35	1,024 × 768 @85 Hz	68.68	85.00	* (94.5)	
36	1,066 × 600 @60 Hz	37.64	59.94	* (53.0)	
37	1,152 × 864 @60 Hz	53.70	60.00		
38	1,152 × 864 @75 Hz	67.50	75.00	* (108.0)	
39	1,280 × 768 @60 Hz	47.70	60.00	* (80.14)	
40	1,280 × 960 @60 Hz	60.00	60.00	* (108.0)	
41	1,280 × 960 @85 Hz	85.94	85.00	* (148.5)	
42	1,280 × 1,024 @60 Hz	63.98	60.02	* (108.0)	*
43	1,280 × 1,024 @75 Hz	79.98	75.03	* (135.0)	
44	1,280 × 1,024 @85 Hz	91.15	85.02	* (157.5)	
45	1,366 × 768 @50 Hz	39.55	50.00		
46	1,366 × 768 @60 Hz	48.36	60.00	* (86.71)	
47	1,400 × 1,050 @60 Hz	65.22	60.00		
48	1,600 × 1,200 @60 Hz	75.00	60.00	* (162.0)	
49	1,600 × 1,200 @65 Hz	81.25	65.00	* (175.5)	
50	1,920 × 1,080 @60 Hz	67.50	60.00	* (148.5) *4	
51	1,920 × 1,200 @60 Hz	74.04	59.95		
52	Macintosh13" (640 × 480)	35.00	66.67	* (30.24)	
53	Macintosh16" (832 × 624)	49.72	74.54	* (57.28)	
54	Macintosh21" (1,152 × 870)	68.68	75.06	* (100.0)	

\*1: Based on SMPTE 274M standard.

\*2: Based on SMPTE RP211 standard.

\*3: Based on SMPTE 295M standard.

\*4: The input signal is recognized as 1,125 (1,080) / 60p.

\*5: When selected the RGB format and 525p signal input to the PC IN terminal, it is recognized as VGA 60Hz signal.

\*6: When inputted VGA 60Hz format signal from the other than PC IN terminal, it is recognized as 525p signal.

\*7: Based on SMPTE 292M and 372M standards. These signals can be received when the Dual Link HD-SDI Terminal Board (TY-FB11DHD) is installed.

**Note:** Signals without above specification may not be displayed properly.

# Shipping condition

This function allows you to reset the unit to the factory setting.

## 1 Display the menu screen.



## 2 Select "Setup".

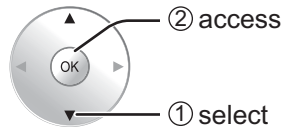
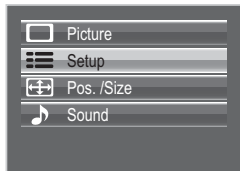

## 3 Select "OSD Language".

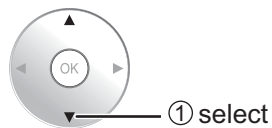
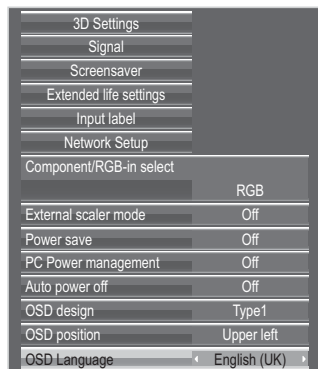

## 4 Press for more than 5 seconds.



## 5 Select "YES".

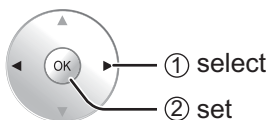
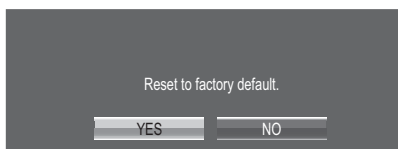

## 6 Select "YES" and wait for 10 sec.

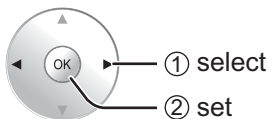
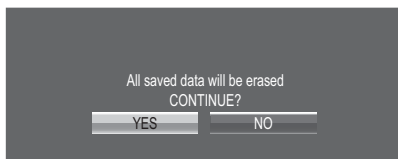

### Note:

Press  to return to Setup menu when confirmation screen is displayed.

[from the unit]

- 1 Press the MENU button till the Setup menu is displayed.
- 2 Press the ▲ or ▼ button to select "OSD Language".
- 3 Press the ENTER button for more than 5 seconds.
- 4 Press the ▲ or ▼ button to select "YES".
- 5 Press the ENTER button.
- 6 Press the ▲ or ▼ button to select "YES".
- 7 Press the ENTER button and wait for 10 sec.

**Executing this function restores all settings and adjustment values in the following menus to the factory-set default values, as shipped.**

On-screen menu: Picture, Advanced settings, Setup, Pos. /Size, Sound, Options  
Unlocking profiles (Memory lock: Off, Password: 0123)

# Specifications

	TH-85VX200W	TH-103VX200W
<b>Power Source</b>	200 - 240 V AC, 50/60 Hz	
<b>Power Consumption</b>		
Power on	1,200 W	1,450 W
Stand-by condition	0.5 W	0.5 W
Power off condition	0.3 W	0.3 W
<b>Plasma Display panel</b>	Drive method : AC type 85-inch, 16:9 aspect ratio	Drive method : AC type 103-inch, 16:9 aspect ratio
<b>Screen size</b>	1,889 mm (W) × 1,062 mm (H) × 2,167 mm (diagonal)	2,269 mm (W) × 1,276 mm (H) × 2,603 mm (diagonal)
(No. of pixels)	2,073,600 (1,920 (W) × 1,080 (H)) [5,760 × 1,080 dots]	
<b>Operating condition</b>		
Temperature	0 °C - 40 °C	
Humidity	20 % - 80 %	
<b>Applicable signals</b>		
Colour System	NTSC, PAL, PAL60, SECAM, Modified NTSC	
Scanning format	525 (480) / 60i · 60p, 625 (575) / 50i · 50p, 750 (720) / 60p · 50p, 1125 (1080) / 60i · 60p · 50i · 50p · 24p · 25p · 30p · 24sF, 1250 (1080) / 50i	
PC signals	VGA, SVGA, XGA, SXGA UXGA .... (compressed) Horizontal scanning frequency 15 - 110 kHz Vertical scanning frequency 48 - 120 Hz	
<b>Connection terminals</b>		
LAN	RJ45 10BASE-T/100BASE-TX, compatible with PLink™	
COMPONENT/RGB IN		
Y/G	RCA Pin jack	with sync 1.0 Vp-p (75 Ω)
PB/CB/B	RCA Pin jack	0.7 Vp-p (75 Ω)
PR/CR/R	RCA Pin jack	0.7 Vp-p (75 Ω)
AUDIO L-R	RCA Pin jack × 2	0.5 Vrms
PC IN	High-Density Mini D-sub 15 Pin	Y or G with sync 1.0 Vp-p (75 Ω) Y or G without sync 0.7 Vp-p (75 Ω) PB/CB/B: 0.7 Vp-p (75 Ω) PR/CR/R: 0.7 Vp-p (75 Ω) HD/VD: 1.0 - 5.0 Vp-p (high impedance) with picture 1.0 Vp-p (high impedance) without picture 0.3 Vp-p (high impedance)
	VBS (use HD port)	0.5 Vrms
AUDIO	Stereo mini jack (M3) × 1	
AV IN	HDMI 1-4	TYPE A Connector × 4 HDMI (Version 1.4 with 3D)
SERIAL	External Control Terminal D-sub 9 Pin	RS-232C compatible
3D SHUTTER OUT	M3 jack × 1, for 3D IR TRANSMITTER	
AUDIO OUT	L-R	RCA PIN JACK × 2 (L / R) Output level: Variable (-∞ — 0 dB)
[INPUT 1 kHz / 0 dB, 10 kΩ Load]		
<b>Dimensions (W × H × D)</b>	2,015 mm × 1,195 mm × 99 mm	2,412 mm × 1,419 mm × 129 mm (141 mm when including protruding portion of terminals)
<b>Mass (weight)</b>	approx. 117.0 kg net	approx. 199.0 kg net

## Notes:

- Design and specifications are subject to change without notice. Mass and dimensions shown are approximate.
- This equipment complies with the EMC standards listed below.  
EN55022, EN55024, EN61000-3-2, EN61000-3-3.

## Information for Users on Collection and Disposal of Old Equipment and used Batteries



These symbols on the products, packaging, and/or accompanying documents mean that used electrical and electronic products and batteries should not be mixed with general household waste. For proper treatment, recovery and recycling of old products and used batteries, please take them to applicable collection points, in accordance with your national legislation and the Directives 2002/96/EC and 2006/66/EC.

By disposing of these products and batteries correctly, you will help to save valuable resources and prevent any potential negative effects on human health and the environment which could otherwise arise from inappropriate waste handling.

For more information about collection and recycling of old products and batteries, please contact your local municipality, your waste disposal service or the point of sale where you purchased the items. Penalties may be applicable for incorrect disposal of this waste, in accordance with national legislation.

### For business users in the European Union

If you wish to discard electrical and electronic equipment, please contact your dealer or supplier for further information.

### [Information on Disposal in other Countries outside the European Union]

These symbols are only valid in the European Union. If you wish to discard these items, please contact your local authorities or dealer and ask for the correct method of disposal.

### Note for the battery symbol (bottom two symbol examples):

This symbol might be used in combination with a chemical symbol. In this case it complies with the requirement set by the Directive for the chemical involved.



Cd

## <Software Information for This Product>

This product has software installed partially licensed under the Free BSD LICENSE.

Free BSD LICENSE regulations under the above specifications are as follows:

(These regulations are set by the third party; therefore the original (English) regulations are stated.)

Copyright © 1980, 1986, 1993

The Regents of the University of California. All rights reserved.

Redistribution and use in source and binary forms, with or without modification, are permitted provided that the following conditions are met:

1. Redistributions of source code must retain the above copyright notice, this list of conditions and the following disclaimer.
2. Redistributions in binary form must reproduce the above copyright notice, this list of conditions and the following disclaimer in the documentation and/or other materials provided with the distribution.
3. All advertising materials mentioning features or use of this software must display the following acknowledgement:  
This product includes software developed by the University of California, Berkeley and its contributors.
4. Neither the name of the University nor the names of its contributors may be used to endorse or promote products derived from this software without specific prior written permission.

THIS SOFTWARE IS PROVIDED BY THE REGENTS AND CONTRIBUTORS "AS IS" AND ANY EXPRESS OR IMPLIED WARRANTIES, INCLUDING, BUT NOT LIMITED TO, THE IMPLIED WARRANTIES OF MERCHANTABILITY AND FITNESS FOR A PARTICULAR PURPOSE ARE DISCLAIMED. IN NO EVENT SHALL THE REGENTS OR CONTRIBUTORS BE LIABLE FOR ANY DIRECT, INDIRECT, INCIDENTAL, SPECIAL, EXEMPLARY, OR CONSEQUENTIAL DAMAGES (INCLUDING, BUT NOT LIMITED TO, PROCUREMENT OF SUBSTITUTE GOODS OR SERVICES; LOSS OF USE, DATA, OR PROFITS; OR BUSINESS INTERRUPTION) HOWEVER CAUSED AND ON ANY THEORY OF LIABILITY, WHETHER IN CONTRACT, STRICT LIABILITY, OR TORT (INCLUDING NEGLIGENCE OR OTHERWISE) ARISING IN ANY WAY OUT OF THE USE OF THIS SOFTWARE, EVEN IF ADVISED OF THE POSSIBILITY OF SUCH DAMAGE.

### Customer's Record

The model number and serial number of this product can be found on its rear panel. You should note this serial number in the space provided below and retain this book, plus your purchase receipt, as a permanent record of your purchase to aid in identification in the event of theft or loss, and for Warranty Service purposes.

Model Number \_\_\_\_\_

Serial Number \_\_\_\_\_

**Panasonic Corporation**

Web Site : <http://panasonic.net>

© Panasonic Corporation 2010

Pursuant to the directive 2004/108/EC, article 9(2)

Panasonic Testing Centre

Panasonic Service Europe, a division of Panasonic Marketing Europe GmbH  
Winsbergring 15, 22525 Hamburg, F.R. Germany