

GEEMARC

# CLEAR SOUND™

HEAR THE DIFFERENCE

## loophear™

# LH600



English

# CONTENTS

<b>CONTENTS</b>	<b>1</b>
<b>INTRODUCTION</b>	<b>2</b>
Unpacking the LH600	3
<b>DESCRIPTION</b>	<b>4</b>
<b>INSTALLATION</b>	<b>7</b>
Setting Up	7
Wall Mounting	8
<b>USING THE LH600</b>	<b>10</b>
Turn the LH600 On/Off	10
Volume Control	10
Tone Control	10
Telephone Use	10
Microphone SENSE Switch	10
Line Input Selector	11
Microphone Input Selector	11
<b>TROUBLESHOOTING</b>	<b>12</b>
<b>SAFETY INFORMATION</b>	<b>13</b>
<b>GUARANTEE</b>	<b>14</b>
<b>RECYCLING DIRECTIVES</b>	<b>16</b>

# INTRODUCTION

Congratulations on purchasing your Geemarc™ LH600. This is a portable induction loop system that is suitable for the home. It is easy to setup and use and fits into any home environment with its sleek and inconspicuous design. The sound quality of the LH600 is unparalleled and will bring great pleasure during its everyday use.

This induction loop system allows a hearing aid user to listen to the TV, radio, CD, ipod, telephone or any other audio device directly into their hearing aid via the telecoil 'T' setting. This means you can listen to one single audio device with no other background noise interfering. Also, the volume can be adjusted without affecting anyone else.

The system simply picks up sound from the audio device. This is done via a microphone or a connection between the audio device and the amplifier. The sound is fed into the amplifier. The amplifier passes the sound into the loop cable (setup around the listening area). This loop transmits the sound to the hearing aid set to the 'T' position.

**Note:** users of digital hearing aids must make sure their aids have been programmed for use with the 'T' setting.

It is important that you read the instructions below in order to use your Geemarc™ LH600 to its full potential. Keep this user guide in a safe place for future reference.



# INTRODUCTION

## Unpacking the LH600

---

When unpacking the LH600 you should find the following in the box:

- 1 LH600 Amplifier Unit
- 1 Power adaptor/charging Unit.
- 1 Telephone line cord
- 1 Telephone adaptor
- 1 External microphone with 3m extension lead and lapel clip
- 1 3.5mm stereo jack to RCA convertor
- 1 2m audio cable with 3.5mm stereo plug
- 1 SCART to RCA jack adaptor
- 1 Loop Cable
- 100 cable clips for the wall
- 1 Wall Mount
- 1 User Guide

# DESCRIPTION

## General Description

---

### Top View

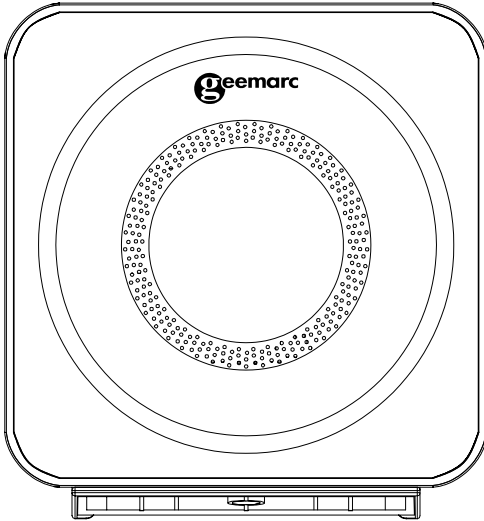

# DESCRIPTION

## Left View

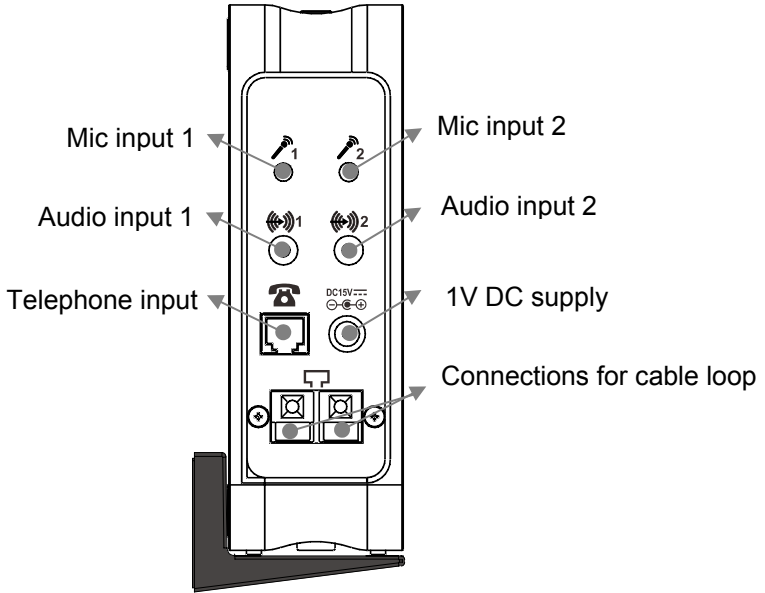

## Right View

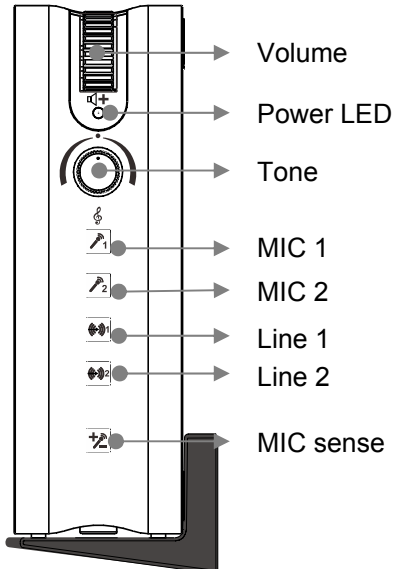

# DESCRIPTION

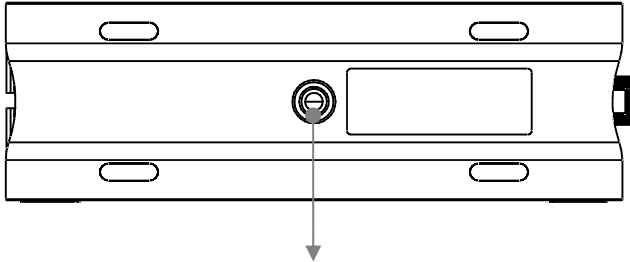

Wall Mount Hanger

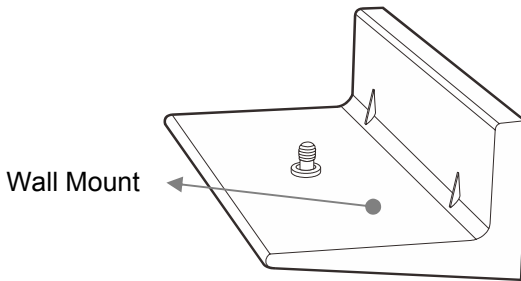

Wall Mount

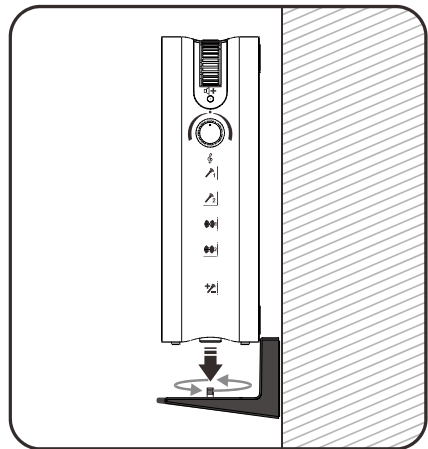
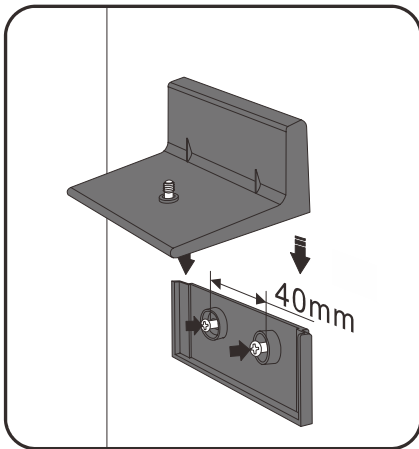

# INSTALLATION

## Setting Up

---

### Connect Amplifier to the Sound Source

Place the amplifier near the sound source and connect the audio leads between the sound source and the amplifier. This direct connection method with leads gives the best results.

#### TV Connection:

**For a TV with SCART connector audio output:** connect the SCART adaptor to the TV set; connect the RCA jack on the SCART adaptor using the RCA convertor cable; connect the 3.5mm stereo cable to the RCA convertor cable; connect the other end of the 3.5mm stereo cable to the unit



stereo jack of LINE 1 .

**For a TV with RCA connector audio output:** connect the RCA convertor cable to the TV set; connect the 3.5mm stereo cable to the RCA convertor cable; connect the other end of the 3.5mm stereo cable to the unit stereo



jack of LINE 1 .

**For a TV with 3.5mm stereo jack audio output:** connect the 3.5mm stereo cable to the TV set; connect the other end of the 3.5mm stereo cable to the





unit stereo jack of LINE1 .

If you have another audio device you wish to connect, use the stereo jack of



LINE2 . You will have to purchase the extra audio leads.

You can test the connection between Line 1 and the loop by pushing the

LINE1 button . The indicator  will light red to confirm. The same can be done to test the connection between Line 2 and the loop. Simply press the LINE2 button and the LINE 2 LED will light up red to confirm the connection.



# INSTALLATION

## Telephone Connection:

Plug the supplied telephone cord into the TEL jack . The other end of the cord should be connected to a telephone convertor adaptor. Push the plug of the telephone convertor into the telephone wall socket.

## Connect the Loop Wire

The unit comes with a 38 meters loop wire. Place the wire on the floor following the wall edges so that the wire runs around the whole room, starting and ending at the amplifier. Either tuck the wire under the carpet or fix to the skirting board or wall using the clips provided. Place the loop wire in the nail clip and hammer the nail clip to the wall in order to fix the loop wire position. Have a space of 20cm between each nail clip. Any excess loop wire can either be cut or tied up. The minimum length of loop wire is

10meters. Insert the two ends of the wire into speaker clip terminals  of the unit. Ensure that only bare wire and not the plastic insulation is inserted.

## Connect the Power Supply

Connect the plug of the supplied power adaptor into the DC jack . Plug the other end of AC power adaptor into the mains wall socket.

## Wall Mounting

---

To wall mount the LH600, drill two holes and insert two screws 40mm apart. Leave about 5 mm of the screw projecting from the wall,. Guide the wall mounting apertures of the wall mount over the screws and slide the wall mount downwards.

Clip the LH600 unit onto the wall mount using the wall mount hanger found on the base of the unit.



Caution: Ensure there are no electrical lines, water pipes etc. in the wall where the holes are drilled

# INSTALLATION



## Connect the Microphone

If for some reason a direct connection is not possible a microphone can be used to pick up the sound source. Or, a microphone can be used simultaneously with line input to pick up background noise e.g. the doorbell. A microphone can also be used for someone to speak directly into the loop system whilst the hearing aid user is listening to a sound source.

Connect the external microphone wire provided into the 2.5mm stereo jack,

marked MIC1  on the unit. Push the button MIC1  to turn on the microphone, the indicator will light red .

If you want to use a second microphone, use the 2.5mm stereo jack, marked

MIC2  on the unit. Push the button MIC2  to turn on the second microphone and the indicator will light red .

# USING THE LH600

## Turn the LH600 On/Off

---

To turn the unit on, turn the rotary volume control clockwise. The rotary volume is located at the corner position of the unit. The power LED will turn



GREEN  to indicate the power is on. To turn the unit off, turn the rotary volume control fully counter-clockwise. The power LED goes off to indicate the unit power is off.

## Volume Control

---

The rotary volume control adjusts the volume received by the hearing aid. Turn fully clockwise for the maximum volume. The power LED will glow red if the signal output is high enough. This power LED indicates that a strong signal is being transmitted around the loop cable.

## Tone Control

---

Turn the tone control clockwise for treble tone control. Turn the tone control counter-clockwise for bass tone control

## Telephone Use



---

When an incoming call is received, the ring signal will be added to the loop output and a ringing sound will be heard. The audio and microphone input will be muted for 10 seconds. The audio source will resume automatically after 10 seconds.

## Microphone SENSE Switch

---

You can select the SENSE switch to select the microphone gain. If you

press the SENSE switch , the red LED will glow red  and the microphone sensitivity is normal. If you want to concentrate on the other sound sources, press the SENSE switch so that the microphone sense LED

is off . The microphone input will be stopped

The microphone sensitivity switch is useful if the room is noisy as the background noise will appear to be reduced.

## Line Input Selector

---

The line selection switches allow you to flick between two different sound sources e.g. television and iPod without having to change leads. Select LINE1 or LINE2 depending on which audio device you require.

Please note: You cannot select both Lines.

# USING THE LH600

## **Microphone Input Selector**

---

The microphone selection switches allow you to flick between two different microphone sources.. Select MIC1 or MIC2 depending on which source you require. Alternatively, you can use both input sources at the same time, simply press both MIC1 and MIC2.

# TROUBLESHOOTING

## **The LH600 is producing no sound**

- Check all connections are secure (microphone, audio sources, loop cable, power cable)
- Ensure the LH600 is turned on (check the Power LED is on)
- Ensure hearing aid is switched to 'T'

## **The sound produced is very quiet**

- Turn the audio device volume higher
- Turn the LH600 volume higher
- Move the microphone closer to the sound source
- Check the loop cable is wired correctly

## **The sound produced is very loud**

- Turn the audio device volume lower
- Turn the LH600 volume lower
- Move the microphone away from the sound source

## **There is a buzz in the background**

- Turn the LH600 off. If the buzz persists, this is interference from other electrical items. However, if the buzz disappears on turning the LH600 off there might be a fault with the system. Contact Geemarc at the address below.

**UK:** 5 Swallow Court Swallowfields Welwyn Garden City Hertfordshire AL7 1SB.

# SAFETY INFORMATION

## **General**

Do not open the unit. Contact the helpline for all repairs.

## **Cleaning**

Clean the LH600 with a soft cloth. Never use polish or cleaning agents - they could damage the finish or the electronics inside.

## **Environmental**

Do not expose to direct sunlight.

Always ensure there is a free flow of air over the surfaces of the LH600.

Do not place any part of your product in water and do not use it in damp or humid conditions e.g. bathrooms.

Do not expose your product to fire or other hazardous conditions.

# GUARANTEE

From the moment your Geemarc™ product is purchased, Geemarc™ guarantee it for the period of one year. During this time, all repairs or replacements (at our discretion) are free of charge. Should you experience a problem then contact our help line or visit our website at [www.geemarc.com](http://www.geemarc.com). The guarantee does not cover accidents, negligence or breakages to any parts. The product must not be tampered with or taken apart by anyone who is not an authorised Geemarc™ representative. The Geemarc™ guarantee in no way limits your legal rights.

IMPORTANT: YOUR RECEIPT IS PART OF YOUR GUARANTEE AND MUST BE RETAINED AND PRODUCED IN THE EVENT OF A WARRANTY CLAIM.

Please note: The guarantee applies to the United Kingdom only

**DECLARATION:** Geemarc™ Telecom SA hereby declares that this product is in compliance with the essential requirements and other relevant provisions of the Radio and Telecommunications Terminal Equipment Directive 1999/5/EEC and in particular article 3 section 1a, 1b and section 2.

*The declaration of conformity may be consulted at [www.geemarc.com](http://www.geemarc.com)*



# GUARANTEE

**Electrical connection:** The apparatus is designed to operate from a 230V 50Hz supply only. (Classified as 'hazardous voltage' according to EN60950 standard).



# RECYCLING DIRECTIVES

The WEEE (Waste Electrical and Electronic Equipment) has been put in place for the products at the end of their useful life are recycled in the best way.

When this product is finished with, please do not put it in your domestic waste bin.

Please use one of the following disposal options:

- Remove the batteries and deposit them in an appropriate WEEE skip.

Deposit the product in an appropriate WEEE skip.

- Or, hand the old product to the retailer. If you purchase a new one, they should accept it.

Thus if you respect these instructions you ensure human health and environmental protection.



For product support and help visit our website at [www.geemarc.com](http://www.geemarc.com)

Telephone 01707 384438

Or fax 01707 832529



UGLoopHear600\_En\_V.1.1

**geemarc** UK

5 Swallow Court  
Swallowfields  
Welwyn Garden City  
Hertfordshire, AL7 1SB  
For product support:  
01707 384438

[www.geemarc.com](http://www.geemarc.com)

**geemarc** FRANCE

Parc de l'Etoile  
2 rue Galilée BP20061  
59791 GRANDE SYNTHÉ CEDEX  
TEL. SERVICE APRES VENTE:  
03 28 58 75 99

[www.geemarc.com](http://www.geemarc.com)

**geemarc** GERMANY

Siemensstrasse 10,  
53121 Bonn  
Germany  
Tel: +49(0)228/ 74 87 09 0  
Fax: +49(0)228/ 74 87 09 20

[www.geemarc.com](http://www.geemarc.com)