

## Operating Instructions Functional Manual

DLP™ Projector Commercial Use

---

Model No. **PT-DZ870E**  
**PT-DW830E**  
**PT-DX100E**

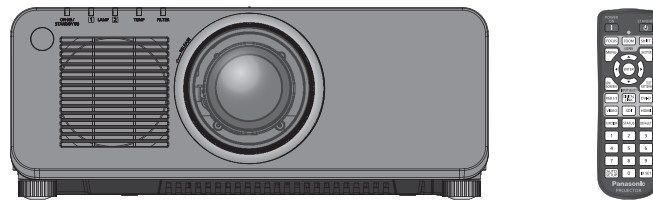

Thank you for purchasing this Panasonic product.

- This manual is common to all the models regardless of suffixes of the Model No.
  - W : White model, the standard zoom lens supplied    LW : White model, the lens sold separately
  - K : Black model, the standard zoom lens supplied    LK : Black model, the lens sold separately
- Before operating this product, please read the instructions carefully and save this manual for future use.
- Before using your projector, be sure to read “Read this first!” (➔ pages 2 to 9).

real D 3D

# Read this first!

**WARNING:** THIS APPARATUS MUST BE EARTHED.

**WARNING:** To prevent damage which may result in fire or shock hazard, do not expose this appliance to rain or moisture.  
This device is not intended for use in the direct field of view at visual display workplaces. To avoid incommoding reflexions at visual display workplaces this device must not be placed in the direct field of view.  
The equipment is not intended for used at a video workstation in compliance BildscharbV.

The sound pressure level at the operator position is equal or less than 70 dB (A) according to ISO 7779.

**WARNING:**

1. Remove the plug from the mains socket when this unit is not in use for a prolonged period of time.
2. To prevent electric shock, do not remove cover. No user serviceable parts inside. Refer servicing to qualified service personnel.
3. Do not remove the earthing pin on the mains plug. This apparatus is equipped with a three prong earthingtype mains plug. This plug will only fit an earthing-type mains socket. This is a safety feature. If you are unable to insert the plug into the mains socket, contact an electrician. Do not defeat the purpose of the earthing plug.

**WARNING:**

This is a class A product. In a domestic environment this product may cause radio interference in which case the user may be required to take adequate measures.

**CAUTION:** To assure continued compliance, follow the attached installation instructions, which include using the provided power cord and shielded interface cables when connecting to computer or peripheral device. If you use serial port to connect PC for external control of projector, you must use a commercial RS-232C serial interface cable with ferrite core. Any unauthorized changes or modifications to this equipment will void the user's authority to operate.

This is a device to project images onto a screen, etc., and is not indented for use as indoor lighting in a domestic environment.

Directive 2009/125/EC

**Importer's name and address within the European Union**

**Panasonic Marketing Europe GmbH**

**Panasonic Testing Center**

**Winsbergring 15, 22525 Hamburg, Germany**

**Product information (for Turkey only)**

EEE Yönetmeliğine Uygundur.

EEE Complies with Directive of Turkey.

## IMPORTANT: THE MOULDED PLUG (U.K. only)

### FOR YOUR SAFETY, PLEASE READ THE FOLLOWING TEXT CAREFULLY.

This appliance is supplied with a moulded three pin mains plug for your safety and convenience. A 13 amp fuse is fitted in this plug. Should the fuse need to be replaced, please ensure that the replacement fuse has a rating of 13 amps and that it is approved by ASTA or BSI to BS1362.

Check for the ASTA mark  or the BSI mark  on the body of the fuse.

If the plug contains a removable fuse cover, you must ensure that it is refitted when the fuse is replaced. If you lose the fuse cover, the plug must not be used until a replacement cover is obtained. A replacement fuse cover can be purchased from an Authorised Service Center.

**If the fitted moulded plug is unsuitable for the mains socket in your home, then the fuse should be removed and the plug cut off and disposed of safely. There is a danger of severe electrical shock if the cut off plug is inserted into any 13 amp socket.**

If a new plug is to be fitted, please observe the wiring code as shown below.

If in any doubt, please consult a qualified electrician.

**WARNING:** THIS APPLIANCE MUST BE EARTHED.

**IMPORTANT:** The wires in this mains lead are coloured in accordance with the following code:

Green - and - Yellow: Earth

Blue: Neutral

Brown: Live

As the colours of the wire in the mains lead of this appliance may not correspond with the coloured markings identifying the terminals in your plug, proceed as follows.

The wire which is coloured GREEN - AND - YELLOW must be connected to the terminal in the plug which is marked with the letter E or by the Earth symbol  or coloured GREEN or GREEN - AND - YELLOW.

The wire which is coloured BLUE must be connected to the terminal in the plug which is marked with the letter N or coloured BLACK.

The wire which is coloured BROWN must be connected to the terminal in the plug which is marked with the letter L or coloured RED.

How to replace the fuse: Open the fuse compartment with a screwdriver and replace the fuse.

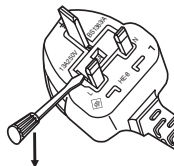

## **WARNING:**

### **■ POWER**

**The wall outlet or the circuit breaker shall be installed near the equipment and shall be easily accessible when problems occur. If the following problems occur, cut off the power supply immediately.**

Continued use of the projector in these conditions will result in fire or electric shock.

- If foreign objects or water get inside the projector, cut off the power supply.
- If the projector is dropped or the cabinet is broken, cut off the power supply.
- If you notice smoke, strange smells or noise coming from the projector, cut off the power supply.

Please contact an Authorized Service Center for repairs, and do not attempt to repair the projector yourself.

**During a thunderstorm, do not touch the projector or the cable.**

Electric shocks can result.

**Do not do anything that might damage the power cord or the power plug.**

If the power cord is used while damaged, electric shocks, short-circuits or fire will result.

- Do not damage the power cord, make any modifications to it, place it near any hot objects, bend it excessively, twist it, pull it, place heavy objects on top of it or wrap it into a bundle.

Ask an Authorized Service Center to carry out any repairs to the power cord that might be necessary.

**Completely insert the power plug into the wall outlet and the power connector into the projector terminal.**

If the plug is not inserted correctly, electric shocks or overheating will result.

- Do not use plugs which are damaged or wall outlets which are coming loose from the wall.

**Do not use anything other than the provided power cord.**

Failure to observe this will result in fire or electric shocks. Please note that if you do not use the provided power cord to ground the device on the side of the outlet, this may result in electric shocks.

**Clean the power plug regularly to prevent it from becoming covered in dust.**

Failure to observe this will cause a fire.

- If dust builds up on the power plug, the resulting humidity can damage the insulation.

Pull the power plug out from the wall outlet and wipe it with a dry cloth regularly.

**Do not handle the power plug and power connector with wet hands.**

Failure to observe this will result in electric shocks.

**Do not overload the wall outlet.**

If the power supply is overloaded (ex., by using too many adapters), overheating may occur and fire will result.

### **■ ON USE/INSTALLATION**

**Do not place the projector on soft materials such as carpets or sponge mats.**

Doing so will cause the projector to overheat, which can cause burns, fire or damage to the projector.

**Do not set up the projector in humid or dusty places or in places where the projector may come into contact with oily smoke or steam, ex. a bathroom.**

Using the projector under such conditions will result in fire, electric shocks or deterioration of components.

Deterioration of components (such as ceiling mount brackets) may cause the projector which is mounted on the ceiling to fall down.

**Do not install this projector in a place which is not strong enough to take the full weight of the projector or on top of a surface which is sloped or unstable.**

Failure to observe this will cause projector to fall down or tip over the projector, and severe injury or damage could result.



**WARNING:**

**Do not cover the air intake/exhaust ports or place anything within 500 mm (20") of them.**

Doing so will cause the projector to overheat, which can cause fire or damage to the projector.

- Do not place the projector in narrow, badly ventilated places.
- Do not place the projector on cloth or papers, as these materials could be drawn into the air intake port.

**Do not place your hands or other objects close to the air exhaust port.**

Doing so will cause burns or damage your hands or other objects.

- Heated air comes out of the air exhaust port. Do not place your hands or face, or objects which cannot withstand heat close to this port.

**Do not look at the light emitted from the lens while the projector is being used.**

Doing so can cause loss of sight.

- Strong light is emitted from the projector's lens. Do not directly look at this light.
- Be especially careful not to let young children look into the lens. In addition, turn off the power and disconnect the power plug when you are away from the projector.

**Never attempt to remodel or disassemble the projector.**

High voltages can cause fire or electric shocks.

- For any inspection, adjustment and repair work, please contact an Authorized Service Center.

**Do not project an image with the lens cover attached.**

Doing so can cause fire.

**Do not allow metal objects, flammable objects, or liquids to enter inside of the projector. Do not allow the projector to get wet.**

Doing so may cause short circuits or overheating, and result in fire, electric shock, or malfunction of the projector.

- Do not place containers of liquid or metal objects near the projector.
- If liquid enters inside of the projector, consult your dealer.
- Particular attention must be paid to children.

**Use the ceiling mount bracket specified by Panasonic.**

Using the ceiling mount bracket other than the specified one will result in falling accidents.

- Attach the supplied safety cable to the ceiling mount bracket to prevent the projector from falling down.

**Installation work (such as ceiling mount bracket) should only be carried out by a qualified technician.**

If installation is not carried out and secured correctly it can cause injury or accidents, such as electric shocks.

- Do not use anything other than an authorized ceiling mount bracket.
- Be sure to use the provided accessory wire with an eye bolt as an extra safety measure to prevent the projector from falling down. (Install in a different location to the ceiling mount bracket.)

**WARNING:**

■ **ACCESSORIES**

**Do not use or handle the batteries improperly, and refer to the following.**

Failure to observe this will cause burns, batteries to leak, overheat, explode or catch fire.

- Use AAA/R03 batteries.
- Do not use unspecified batteries.
- Do not use chargeable batteries.
- Do not disassemble dry cell batteries.
- Do not heat the batteries or place them into water or fire.
- Do not allow the + and – terminals of the batteries to come into contact with metallic objects such as necklaces or hairpins.
- Do not store or carry batteries together with metallic objects.
- Store the batteries in a plastic bag and keep them away from metallic objects.
- Make sure the polarities (+ and –) are correct when inserting the batteries.
- Do not use a new battery together with an old battery or mix different types of batteries.
- Do not use batteries with the outer cover peeling away or removed.

**If the battery fluid leaks, do not touch it with bare hands, and take the following measures if necessary.**

- Battery fluid on your skin or clothing could result in skin inflammation or injury.  
Rinse with clean water and seek medical advice immediately.
- Battery fluid coming in contact with your eyes could result in loss of sight.  
In this case, do not rub your eyes. Rinse with clean water and seek medical advice immediately.

**Do not disassemble the lamp unit.**

If the lamp breaks, it could cause injury.

**Lamp replacement**

The lamp has high internal pressure. If improperly handled, an explosion and severe injury or accidents will result.

- The lamp can easily explode if struck against hard objects or dropped.
- Before replacing the lamp unit, be sure to turn the power off and to disconnect the power plug from the wall outlet.  
Electric shocks or explosions can result if this is not done.
- When replacing the lamp unit, turn the power off and allow the lamp to cool for at least one hour before handling it otherwise it can cause burns.

**Do not use the supplied power cord with devices other than this projector.**

- Using the supplied power cord with devices other than this projector may cause short circuits or overheating, and result in electric shock or fire.

**Do not allow children to reach the batteries (AAA/R03).**

Accidentally swallowing them can cause physical harm.

- If swallowed, seek medical advice immediately.

**Remove the depleted batteries from the remote control promptly.**

- Leaving them in the unit may result in fluid leakage, overheating, or explosion of the batteries.

## CAUTION:

### ■ POWER

**When disconnecting the power cord, be sure to hold the power plug and power connector.**

If the power cord itself is pulled, the lead will become damaged, and fire, short-circuits or serious electric shocks will result.

**When not using the projector for an extended period of time, disconnect the power plug from the wall outlet.**

Failure to do so may result in fire or electric shock.

**Disconnect the power plug from the wall outlet before carrying out any cleaning and replacing the unit.**

Failure to do so may result in electric shock.

### ■ ON USE/INSTALLATION

**Do not place heavy objects on top of the projector.**

Failure to observe this will cause the projector to become unbalanced and fall, which could result in damage or injury. The projector will be damaged or deformed.

**Do not put your weight on this projector.**

You could fall or the projector could break, and injury will result.

- Be especially careful not to let young children stand or sit on the projector.

**Do not place the projector in extremely hot locations.**

Doing so will cause the outer casing or internal components to deteriorate, or result in fire.

- Take particular care in locations exposed to direct sunlight or near stoves.

**Do not place your hands in the openings beside the optical lens, while shifting the lens.**

Failure to observe this could cause injury.

**Do not stand in front of the lens while the projector is being used.**

Doing so can cause damage and burns to clothing.

- Extremely strong light is emitted from the projector's lens.

**Do not place objects in front of the lens while the projector is being used.**

Doing so can cause damage to the object and can cause the set to malfunction.

- Extremely strong light is emitted from the projector's lens.

**Always disconnect all cables before moving the projector.**

Moving the projector with cables still attached can damage the cables, which will cause fire or electric shocks to occur.

**When mounting the projector on the ceiling, keep mounting screws and power cord from contact with metal parts inside the ceiling.**

Contact with metal parts inside the ceiling can cause electric shocks.

### ■ ACCESSORIES

**Do not use the old lamp unit.**

If used it could cause lamp explosion.

**If the lamp has broken, ventilate the room immediately. Do not touch or bring your face close to the broken pieces.**

Failure to observe this will cause the user to absorb the gas which was released when the lamp broke and which contains nearly the same amount of mercury as fluorescent lamps, and the broken pieces will cause injury.

- If you believe that you have absorbed the gas or that the gas has got into your eyes or mouth, seek medical advice immediately.
- Ask your dealer about replacing the lamp unit and check the inside of the projector.

**When not using the projector for an extended period of time, remove the batteries from the remote control.**

Failure to observe this will cause the batteries to leak, overheat, catch fire or explode, which may result in fire or contamination of surrounding area.

**CAUTION:**

■ **MAINTENANCE**

**Do not touch the fan with your fingers or any other parts of your body when replacing the lamp unit.**  
Doing so can cause injury.

**Ask your dealer about cleaning inside the projector once a year.**  
Continuous use while dust is accumulated inside the projector may result in fire.

- For cleaning fee, ask your dealer.

■ **VIEWING 3D VIDEO**

**Those with a medical history of oversensitivity to light, heart problems, or poor physical health should not view 3D images.**

This may lead to a worsening of medical conditions.

**If you feel tiredness or discomfort, or other abnormality while viewing with 3D Eyewear, discontinue viewing.**

Continuing use may cause health problems. Take a break as necessary.

**When viewing 3D movies, aim to view one movie at a time and take a break as necessary.**

**When viewing 3D images, for example when playing 3D games or using a PC where two way interaction is possible, take an appropriate break every 30 to 60 minutes.**

Watching for long periods of time may cause eye fatigue.

**When preparing contents, use contents properly created to be used for 3D.**

This may cause eye fatigue or health problems.

**When viewing 3D images, pay attention to people and objects in the vicinity.**

3D video may be mistaken for actual objects, and the related bodily movements can cause damage to objects and lead to injury.

**Use 3D Eyewear when viewing 3D videos.**

**Do not tilt your head when viewing with 3D Eyewear.**

**Those who are near or far sighted, those with weaker eyesight in one eye, or those with astigmatism should use corrective glasses etc. when using 3D Eyewear.**

**If the image appears distinctly double when viewing 3D video, discontinue viewing.**

Watching for long periods of time may cause eye fatigue.

**View at a distance of at least three times the effective height of the screen.**

Viewing at distance closer than the recommended distance may cause eye fatigue. As with movies, if there are black bands at the top and bottom of the video, view at a distance of 3 times or more of the height of the video section.

**Children younger than 5 or 6 years old should not use 3D Eyewear.**

As it is difficult to gauge the reactions of children to fatigue and discomfort their condition may worsen suddenly. If a child uses the 3D Eyewear, guardians should beware of the child's eyes becoming tired.



## To remove the battery

### Remote Control Battery

1. Press the guide and lift the cover.

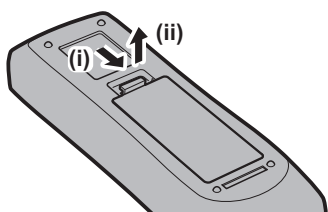

2. Remove the batteries.

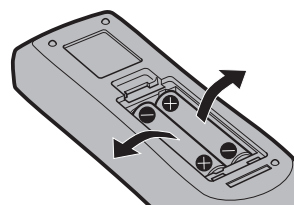

---

## ■ Trademarks

- Windows®, Windows Vista®, and Internet Explorer® are registered trademarks or trademarks of Microsoft Corporation in the United States and other countries.
- Mac, Mac OS, OS X, and Safari are trademarks of Apple Inc., registered in the United States and other countries.
- PJLink™ is a registered trademark or pending trademark in Japan, the United States, and other countries and regions.
- HDMI, the HDMI Logo, and High-Definition Multimedia Interface are trademarks or registered trademarks of HDMI Licensing LLC in the United States and other countries.
- VGA and XGA are trademarks of International Business Machines Corporation in the United States.
- SVGA is a trademark or registered trademark of Video Electronics Standards Association.
- RoomView and Crestron RoomView are registered trademarks of Crestron Electronics, Inc.  
Crestron Connected and Fusion RV are trademarks of Crestron Electronics, Inc.
- Adobe Flash Player is a trademark or registered trademark of Adobe Systems Inc. in the United States and/or other countries.
- RealD 3D is a trademark of RealD Inc.
- Some of the fonts used in the on-screen menu are Ricoh bitmap fonts, which are manufactured and sold by Ricoh Company, Ltd.
- All other names, company names, and product names mentioned in this manual are trademarks or registered trademarks of their respective owners.  
Please note that the ® and ™ symbols are not specified in this manual.

## ■ Illustrations in this manual

- Illustrations of the projector, screen, and other parts may vary from the actual product.

## ■ Reference pages

- Reference pages in this manual are indicated as (➡ page 00).

## ■ Term

- In this manual, the “Wireless/wired remote control unit” accessory is referred to as “Remote control”.

## Features of the Projector

### High luminance, high contrast, and high color reproduction

- ▶ With a unique optical system and advanced lamp drive system, high luminance of 10 000 lm\*1 and high contrast of 10 000:1, and high color reproduction are achieved even with its compact size.

\*1 For PT-DX100E  
PT-DZ870E and PT-DW830E is 8 500 lm.

### Easy and highly flexible setup

- ▶ Easy and highly flexible setup is achieved by compatibility to DIGITAL LINK and Art-Net, 3D function support, 3G-SDI standard support\*1, standard support of geometric adjustment function\*1, and a lineup of various optional lenses.

\*1 Only for PT-DZ870E.

### Energy conservation achieved through the ECO function

- ▶ Environment-friendly projector with the recommended lamp replacement interval of 4 000 H\*1 and with a low standby power.

\*1 When [LAMP POWER] is set to [ECO]

## Quick Steps

For details, refer to the corresponding pages.

1. Set up the projector.  
(⇒ page 32)



2. Attach the projection lens.  
(⇒ page 47)



3. Connect with external devices.  
(⇒ page 49)



4. Connect the power cord.  
(⇒ page 54)



5. Switch on the projector.  
(⇒ page 55)



6. Make initial settings.  
(⇒ page 22)

- Take this step when you switch on the power for the first time after purchasing the projector.



7. Select the input signal.  
(⇒ page 58)



8. Adjust the image.  
(⇒ page 58)

# Contents

Be sure to read “Read this first!” from page 2.

## Read this first! ..... 2

### Chapter 1 Preparation

<b>Precautions for use</b> .....	<b>16</b>
Cautions when transporting .....	16
Cautions when installing .....	16
Security .....	18
DIGITAL LINK .....	18
Art-Net menu .....	18
Disposal .....	18
Cautions on use .....	19
Accessories .....	20
Optional accessories .....	21
<b>Start-up display</b> .....	<b>22</b>
Focus adjustment .....	22
Initial setting (display language) .....	22
Initial setting (installation setting) .....	23
Initial setting (stand by mode) .....	23
Initial setting (screen setting) .....	24
<b>About your projector</b> .....	<b>25</b>
Remote control .....	25
Projector body .....	26
<b>Using the remote control</b> .....	<b>29</b>
Inserting and removing the batteries .....	29
Setting the remote control ID numbers .....	29
Connecting to the projector with a cable .....	30

### Chapter 2 Getting Started

<b>Setting up</b> .....	<b>32</b>
Installation mode .....	32
Parts for ceiling mount (optional) .....	32
Screen size and throw distance .....	33
Adjusting adjustable feet .....	46
<b>Removing/attaching the projection lens</b> .....	<b>47</b>
Removing the projection lens .....	47
Attaching the projection lens .....	48
<b>Connecting</b> .....	<b>49</b>
Before connecting .....	49
Connecting example: AV equipment .....	50
Connecting example: Computers .....	51
Connecting example: Twisted-pair-cable transmitter .....	52

### Chapter 3 Basic Operations

<b>Switching on/off the projector</b> .....	<b>54</b>
Connecting the power cord .....	54
Power indicator .....	54
Switching on the projector .....	55
Making adjustments and selections .....	56
Switching off the projector .....	57
Direct power off function .....	57
<b>Projecting</b> .....	<b>58</b>
Selecting the input signal .....	58
Adjusting the focus, zoom, and shift .....	58
Moving the lens to the home position .....	59
Adjustment range by the lens position shift (optical shift) .....	59
<b>Operating with the remote control</b> .....	<b>61</b>
Using the shutter function .....	61
Using the on-screen display function .....	61
Switching the input signal .....	62
Using the status function .....	62
Using the automatic setup function .....	63
Using the function button .....	63
Displaying the internal test pattern .....	63

### Chapter 4 Settings

<b>Menu navigation</b> .....	<b>65</b>
Navigating through the menu .....	65
Main menu .....	66
Sub-menu .....	67
<b>[PICTURE] menu</b> .....	<b>71</b>
[PICTURE MODE] .....	71
[CONTRAST] .....	71
[BRIGHTNESS] .....	71
[COLOR] .....	72
[TINT] .....	72
[COLOR TEMPERATURE] .....	72
[WHITE GAIN] .....	74
[GAMMA] .....	74
[SYSTEM DAYLIGHT VIEW] .....	74
[SHARPNESS] .....	75
[NOISE REDUCTION] .....	75
[DYNAMIC IRIS] .....	75
[SYSTEM SELECTOR] .....	76
sRGB-compliant video .....	77



## Contents

<b>[POSITION] menu</b> .....	<b>78</b>	<b>[DISPLAY OPTION] menu</b> .....	<b>95</b>
[SHIFT].....	78	[COLOR MATCHING].....	95
[ASPECT].....	78	[COLOR CORRECTION].....	96
[ZOOM].....	79	[SCREEN SETTING].....	96
[CLOCK PHASE].....	80	[AUTO SIGNAL].....	97
[GEOMETRY(2D)].....	80	[AUTO SETUP].....	97
[KEYSTONE(3D)].....	82	[RGB IN].....	98
[KEYSTONE].....	83	[DVI-D IN].....	98
<b>[ADVANCED MENU] menu</b> .....	<b>84</b>	[HDMI IN].....	99
[DIGITAL CINEMA REALITY].....	84	[DIGITAL LINK IN].....	99
[BLANKING].....	84	[SDI IN].....	100
[INPUT RESOLUTION].....	85	[ON-SCREEN DISPLAY].....	101
[CLAMP POSITION].....	85	[CLOSED CAPTION SETTING] (NTSC or 480i Y <sub>C</sub> B <sub>C</sub> R signal input only).....	102
[EDGE BLENDING].....	86	[BACK COLOR].....	103
[FRAME RESPONSE].....	87	[STARTUP LOGO].....	103
[FRAME LOCK].....	88	[UNIFORMITY].....	103
[RASTER POSITION].....	88	[SHUTTER SETTING].....	104
<b>[DISPLAY LANGUAGE] menu</b> .....	<b>89</b>	[FREEZE].....	105
Changing the display language.....	89	[WAVEFORM MONITOR].....	105
<b>[3D SETTINGS] menu</b> .....	<b>90</b>	[CUT OFF].....	106
[3D SYSTEM SETTING].....	90	<b>[PROJECTOR SETUP] menu</b> .....	<b>108</b>
[DLP Link].....	90	[PROJECTOR ID].....	108
[3D SYNC SETTING].....	90	[PROJECTION METHOD].....	108
[3D SIMUL INPUT SETTING].....	91	[COOLING CONDITION].....	109
[3D INPUT FORMAT].....	91	[HIGH ALTITUDE MODE].....	109
[3D 24Hz IMAGE PROJECTION].....	92	[LAMP SELECT].....	109
[3D 24Hz IMAGE POSITION].....	92	[LAMP RELAY].....	110
[LEFT/RIGHT SWAP].....	92	[LAMP POWER].....	111
[SUB CLOCK PHASE].....	93	[BRIGHTNESS CONTROL].....	111
[3D FRAME DELAY].....	93	[STANDBY MODE].....	116
[3D TEST MODE].....	93	[SCHEDULE].....	116
[3D TEST PATTERN].....	93	[STARTUP INPUT SELECT].....	117
[SAFETY PRECAUTIONS MESSAGE].....	94	[RS-232C].....	118
[3D SAFETY PRECAUTIONS].....	94	[STATUS].....	119
		[NO SIGNAL SHUT-OFF].....	120
		[REMOTE2 MODE].....	121
		[FUNCTION BUTTON].....	121
		[DATE AND TIME].....	121
		[LENS CALIBRATION].....	122
		[SAVE ALL USER DATA].....	122
		[LOAD ALL USER DATA].....	123
		[INITIALIZE].....	123
		[SERVICE PASSWORD].....	123
		<b>[P IN P] menu</b> .....	<b>124</b>
		Using P IN P function.....	124
		<b>[TEST PATTERN] menu</b> .....	<b>126</b>
		[TEST PATTERN].....	126

## Contents

<b>[SIGNAL LIST] menu</b> .....	<b>127</b>	<b>Precautions for Ceiling Mount Bracket</b> .....	<b>187</b>
Registering new signals .....	127	<b>Index</b> .....	<b>188</b>
Renaming the registered signal .....	127		
Deleting the registered signal .....	127		
Protecting the registered signal .....	128		
Expanding signal lock-in range .....	128		
Sub memory .....	129		
<b>[SECURITY] menu</b> .....	<b>130</b>		
[SECURITY PASSWORD] .....	130		
[SECURITY PASSWORD CHANGE] .....	130		
[DISPLAY SETTING] .....	131		
[TEXT CHANGE] .....	131		
[CONTROL DEVICE SETUP] .....	131		
[CONTROL DEVICE PASSWORD CHANGE]			
.....	133		
<b>[NETWORK] menu</b> .....	<b>134</b>		
[DIGITAL LINK MODE] .....	134		
[DIGITAL LINK SETUP] .....	134		
[DIGITAL LINK STATUS] .....	135		
[NETWORK SETUP] .....	135		
[NETWORK CONTROL] .....	136		
[NETWORK STATUS] .....	136		
[DIGITAL INTERFACE BOX] .....	136		
[Art-Net SETUP] .....	136		
Network connections .....	137		
Connecting to a twisted-pair-cable transmitter			
.....	137		
Accessing from the web browser .....	138		

## Chapter 5 Maintenance

<b>Lamp/temperature/filter indicators</b> .....	<b>157</b>
When an indicator lights up .....	157
<b>Maintenance/replacement</b> .....	<b>159</b>
Before performing maintenance/replacement .....	159
Maintenance .....	159
Replacing the unit .....	160
<b>Troubleshooting</b> .....	<b>164</b>

## Chapter 6 Appendix

<b>Technical information</b> .....	<b>167</b>
PJLink protocol .....	167
Using Art-Net function .....	168
Control commands via LAN .....	170
<SERIAL IN>/<SERIAL OUT> terminal .....	171
<REMOTE 2 IN> terminal .....	176
Two-window display combination list .....	177
Control device password .....	177
Upgrade Kit .....	178
List of compatible signals .....	178
<b>Specifications</b> .....	<b>183</b>
<b>Dimensions</b> .....	<b>186</b>

# Chapter 1 Preparation

---

This chapter describes things you need to know or check before using the projector.

# Precautions for use

## Cautions when transporting

- If you purchased the projector with the standard zoom lens, remove the lens cushion before use, and store it for the future use. When transporting the projector, move the lens position to the home position and attach the lens cushion. If you purchased the projector with the lens sold separately, remove the lens hole cover before use, and store it for the future use. When transporting the projector, move the lens position to the home position, remove the projection lens, and then attach the lens hole cover.
- For the steps to move the lens to the home position, refer to “Moving the lens to the home position” (➔ page 59).

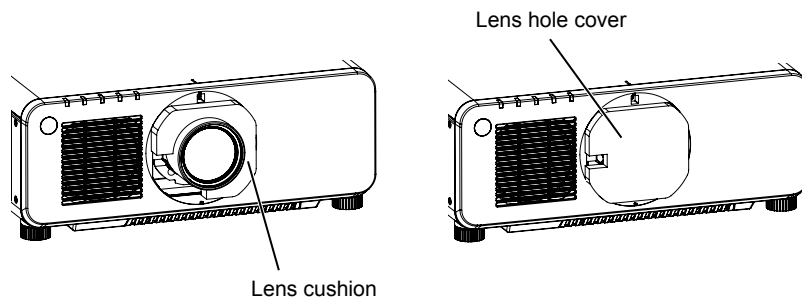

- When transporting the projector, hold it securely by its bottom and avoid excessive vibration and impacts. They may damage the internal components and result in malfunctions.
- Do not transport the projector with the adjustable feet extended. Doing so may damage the adjustable feet.

## Cautions when installing

### ■ After attachment of the projection lens, be sure to attach the Lens Mount Cover.

Otherwise dust will accumulate inside and may cause malfunctions.

### ■ Do not set up the projector outdoors.

The projector is designed for indoor use only.

### ■ Do not set up the projector in the following locations.

- Places where vibration and impacts occur such as in a car or vehicle: Doing so may cause damage to internal components or malfunction.
- Near the exhaust of an air conditioner: Depending on the conditions of use, the screen may fluctuate in rare cases due to the heated air from the air exhaust port or the hot or cooled air. Make sure that the exhaust from the projector or other equipment, or the air from the air conditioner does not blow toward the front of the projector.
- Places with sharp temperature fluctuations such as near lights (studio lamps): Doing so may shorten the life of the lamp, or result in deformation of the outer case due to heat, which may cause malfunctions.  
The operating environment temperature of the projector should be between 0 °C (32 °F) and 45 °C (113 °F) when using it at elevations lower than 1 400 m (4 593') above sea level, and between 0 °C (32 °F) and 40 °C (104 °F) when using it at high altitudes (1 400 m (4 593') or higher – lower than 2 700 m (8 858') above sea level).
- Near high-voltage power lines or near motors: Doing so may interfere with the operation of the projector.
- Places where there is high-power laser equipment: Directing a laser beam onto the projection lens surface causes damage to the DLP chips.

### ■ Be sure to ask a specialized technician or your dealer when installing the projector on a ceiling.

The optional Ceiling Mount Bracket is required.

Model No.: ET-PKD120H (for high ceilings), ET-PKD120S (for low ceilings), ET-PKD120B (Projector Mount Bracket)

### ■ Ask a qualified technician or your dealer to install the cable wiring for DIGITAL LINK connection.

Image and sound may be disrupted if cable transmission characteristics cannot be obtained due to inadequate installation.

■ **The projector may not work properly due to strong radio wave from the broadcast station or the radio.**

If there is any facility or equipment, which outputs strong radio wave, near the installation location, install the projector at a location sufficiently far from the source of the radio wave. Or, wrap the LAN cable connected to the <DIGITAL LINK/LAN> terminal by using a piece of metal foil or a metal pipe, of which is grounded at both ends.

■ **Focus adjustment**

The high clarity projection lens is thermally affected by the light from the light source, making the focus unstable in the period just after switching on the power. Wait at least 30 minutes with the image projected before adjusting the lens focus.

■ **Make sure to set [HIGH ALTITUDE MODE] to [ON] when using the projector at elevations between 1 400 m (4 593') or higher and lower than 2 700 m (8 858') above sea level.**

Failure to do so may shorten the life of the components and result in malfunctions.

■ **Make sure to set [HIGH ALTITUDE MODE] to [OFF] when using the projector at elevations lower than 1 400 m (4 593') above sea level.**

Failure to do so may shorten the life of the components and result in malfunctions.

■ **Do not install the projector at elevations of 2 700 m (8 858') or higher above sea level.**

Doing so may shorten the life of the components and result in malfunctions.

■ **Do not use the projector tilted to the right or left.**

Using the projector at a vertical angle that exceeds 15° may reduce product life or result in malfunction.

■ **Cautions when setting up the projector**

- When installing the projector at the section other than the floor by using the adjustable feet, use six screw holes for ceiling mount for fixing the projector (as shown in the figure).  
(Screw diameter: M6, tapping depth inside the set: 12 mm (15/32"), torque: 4±0.5 N·m)
- Make a clearance of at least 20 mm (25/32") between the projector bottom and the setting surface by inserting spacers (metallic) between them.

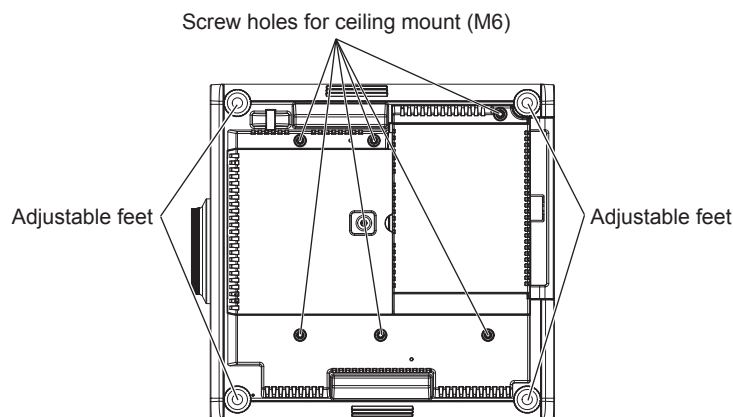

The positions of screw holes for ceiling mount and adjustable feet

- Use the adjustable feet only for the floor standing installation and for adjusting the angle. Using them for other purposes may damage the projector.
- Do not stack projectors on top of each other.
- Do not use the projector supporting it by the top.
- Do not use the projector tilted at an angle that exceeds ±15° from the horizontal plane.
- Do not block the ventilation ports (intake and exhaust) of the projector.

- Prevent hot and cool air from the air conditioning system to blow directly to the ventilation ports (intake and exhaust) of the projector.

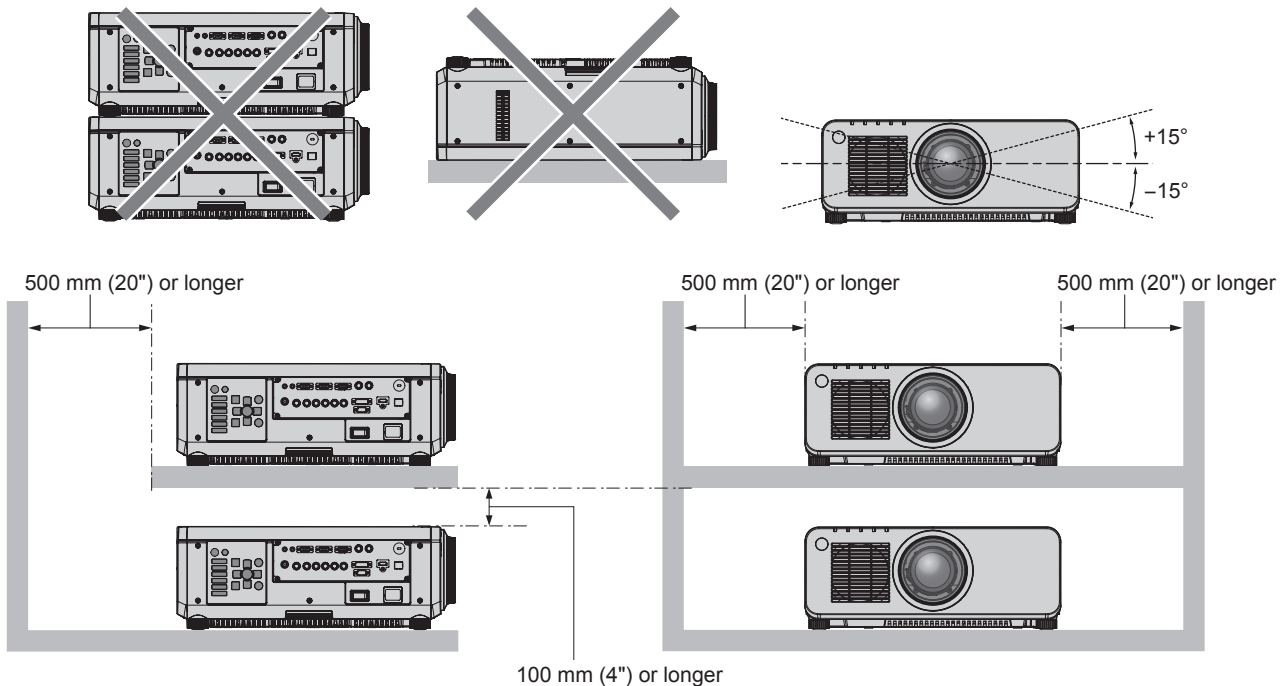

- Do not install the projector in a confined space.  
When it is necessary to install the projector in a confined space, install the air conditioning or ventilation separately. Exhaust heat may accumulate when the ventilation is not enough, triggering the protection circuit of the projector.

## Security

When using this product, take safety measures against the following incidents.

- Personal information being leaked via this product
- Unauthorized operation of this product by a malicious third party
- Interfering or stopping of this product by a malicious third party

Take sufficient security measures. (➔ pages 130, 152)

- Make your password difficult to guess as much as possible.
- Change your password periodically.
- Panasonic Corporation or its affiliate companies will never ask for your password directly. Do not divulge your password in case you receive such inquiries.
- The connecting network must be secured by a firewall, etc.
- Set a password for the web control and restrict the users who can log in.

## DIGITAL LINK

“DIGITAL LINK” is a technology that uses a twisted-pair-cable to transmit video, audio, Ethernet, and serial control signals. The projector supports the optional Digital Interface Box (Model No.: ET-YFB100G), and the “XTP transmitter” of Extron Electronics. For twisted-pair-cable transmitter of other manufacturers of which the operation has been verified with the DIGITAL LINK compatible projector, refer to Panasonic website (<http://panasonic.net/avc/projector/>). Note that the verification for devices of other manufacturers has been made for the items set by Panasonic Corporation, and not all the operations have been verified. For operation or performance problems caused by the devices of other manufacturers, contact the respective manufacturers. In addition, audio function is not equipped with the projector. Therefore, audio transmission is not supported.

## Art-Net menu

“Art-Net” is an Ethernet communication protocol based on the TCP/IP protocol. By using the DMX controller and the application software, illumination and stage system can be controlled. Art-Net is made based on DMX512 communication protocol.

## Disposal

To dispose of the product, ask your local authorities or dealer for correct methods of disposal.

The lamp contains mercury. When disposing of used lamp units, contact your local authorities or dealer for correct methods of disposal.

## Cautions on use

### ■ To get a good picture quality

In order to view a beautiful image in higher contrast, prepare an appropriate environment. Draw curtains or blinds over windows and turn off any lights near the screen to prevent outside light or light from indoor lamps from shining onto the screen.

### ■ Do not touch the surface of the projection lens with your bare hands.

If the surface of the projection lens becomes dirty from fingerprints or anything else, this will be magnified and projected onto the screen.

Attach the supplied lens cover to the projection lens of the projector or an optional projection lens when you do not use the projector.

### ■ DLP chips

- The DLP chips are precision-made. Note that in rare cases, pixels of high precision could be missing or always lit. Note that such phenomena do not indicate malfunction.
- Directing a high-power laser beam onto the projection lens surface can damage the DLP chips.

### ■ Do not move the projector or subject it to vibration or impact while it is operating.

Doing so may shorten the life of the built-in motor.

### ■ Lamp

The light source of the projector is a high-pressure mercury lamp.

A high-pressure mercury lamp has the following characteristics.

- The luminance of the lamp will decrease by duration of usage.
- The lamp may burst with a loud sound or have its service life shortened because of shock, chipping, or degradation due to cumulative runtime.
- The lamp life varies greatly depending on individual differences and usage conditions. In particular, frequent on/off switching of the power greatly deteriorate the lamp and affects the lamp life.
- Continuous use for over one week will deteriorate the lamp. The degradation of the lamp due to continuous use can be reduced by using the [PROJECTOR SETUP] menu → [LAMP RELAY].
- In rare cases, the lamps burst shortly after projection starts.
- The risk of bursting increases when the lamp is used beyond its replacement cycle. Make sure to replace the lamp unit regularly.  
("When to replace the lamp unit" (➔ page 161), "How to replace the lamp unit" (➔ page 162))
- If the lamp bursts, gas contained inside of the lamp is released in the form of smoke.
- It is recommended that you store the Replacement lamp unit as a contingency.

### ■ Computer and external device connections

- When connecting a computer or an external device, read this manual carefully regarding the use of power cords and shielded cables as well.
- Use a commercial cable with a ferrite core for connecting with the <DVI-D IN> terminal.

### ■ Viewing 3D images

The projector can display 3D video signals that are input through various systems such as "frame packing" and "side by side." In addition, the projector corresponds to DLP Link system 3D eyewear. However, not all the 3D eyewear operations are warranted.

You are required to prepare external devices for viewing 3D images (such as 3D eyewear, video signal output devices) which are suitable for your 3D system. For connections of the projector and external devices, they are different depends on the 3D system to be used, see the operating instructions of external devices you use.

Refer to "List of 3D compatible signals" (➔ page 180) for the types of 3D video signals that can be used with the projector.

## Accessories

Make sure that the following accessories are provided with your projector. Numbers enclosed in < > show the number of accessories.

### Wireless/wired remote control unit <1> (N2QAYA000060)



### Lens Mount Cover <1> (TKPB62301)

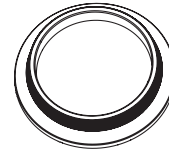

### Power cord <1> (TXFSX01RGRZ)

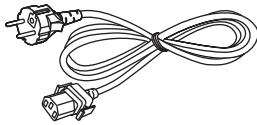

### Lens cover <1> (TKKL5244-1)

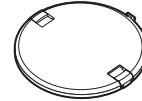

(Only models with lens)

### Power cord <1> (TXFSX02RGRZ)

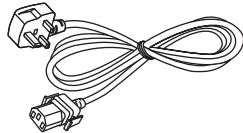

### CD-ROM <1> (TXFQB02VLJ1)



### AAA/R03 battery <2>

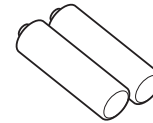

(For remote control unit)

## Attention

- After unpacking the projector, discard the power cord cap and packaging material properly.
- Do not use the supplied power cord for devices other than this projector.
- For missing accessories, consult your dealer.
- Store small parts in an appropriate manner, and keep them away from small children.

## Note

- The model numbers of accessories are subject to change without prior notice.

## Contents of the supplied CD-ROM

The contents of the supplied CD-ROM are as follows.

Instruction/list (PDF)	Operating Instructions – Functional Manual	
	Multi Projector Monitoring & Control Software Operating Instructions	
	Logo Transfer Software Operating Instructions	
	List of Compatible Projector Models	This is a list of projectors that are compatible with the software contained in the CD-ROM and their restrictions.
Software	Multi Projector Monitoring & Control Software (Windows)	This software allows you to monitor and control multiple projectors connected to the LAN.
	Logo Transfer Software (Windows)	This software allows you to transfer original images, such as company logos to be displayed when projection starts, to the projector.



## Optional accessories

Optional accessories (product name)	Model No.	
Projection lens	Zoom lens	ET-DLE085, ET-DLE150, ET-DLE250, ET-DLE350, ET-DLE450
	Fixed-focus lens	ET-DLE055
Ceiling Mount Bracket	ET-PKD120H (for high ceilings), ET-PKD120S (for low ceilings), ET-PKD120B (Projector Mount Bracket)	
Replacement lamp unit	ET-LAD120 (1 pc), ET-LAD120W (2 pcs)	
Upgrade Kit	ET-UK20 (only for PT-DZ870E)	
Digital Interface Box	ET-YFB100G	

### Note

- The model numbers of optional accessories are subject to change without prior notice.

# Start-up display

When the projector is switched on for the first time after purchase as well as when [ALL USER DATA] in the [PROJECTOR SETUP] menu → [INITIALIZE] is executed, the focus adjustment screen is displayed after projection starts, then the initial setting screen is displayed. Set them in accordance with circumstances.

In other occasions, you can change the settings by menu operations.

## Focus adjustment

Adjust the focus to display the menu screen clearly.

You may also need to adjust the zoom and shift.

Refer to "Adjusting the focus, zoom, and shift" (➔ page 58) for details.

- 1) Press ▲▼◀▶ to adjust the focus.

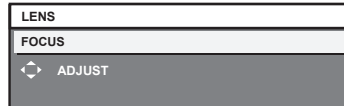

- 2) Press the <MENU> button to proceed to the initial setting.

## Initial setting (display language)

Select the language to show on the screen.

After completed the initial setting, you can change the display language from the [DISPLAY LANGUAGE] menu.

- 1) Press ▲▼ to select the display language.



- 2) Press the <ENTER> button to proceed to the initial setting.

## Initial setting (installation setting)

Set [PROJECTION METHOD] and [COOLING CONDITION] depending on the installation mode. Refer to “Installation mode” (➔ page 32) for details.

Set [HIGH ALTITUDE MODE] to [ON] when using the projector at high altitudes between 1 400 m (4 593') or higher and lower than 2 700 m (8 858') above sea level.

After completed the initial setting, you can change the settings of each item from the [PROJECTOR SETUP] menu.

- 1) Press ▲▼ to select an item.
- 2) Press ◀▶ to switch the setting.

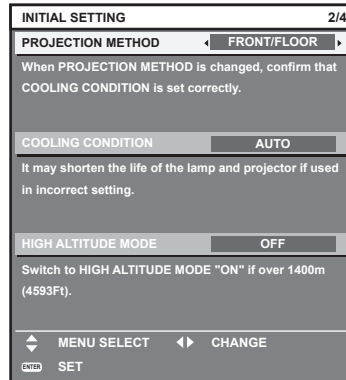

- 3) Press the <ENTER> button to proceed to the initial setting.

## Initial setting (stand by mode)

Set the operation mode during the standby. The default setting is [ECO] that keeps power consumption low during standby. When the network function is used during standby, set to [NORMAL]. After completed the initial setting, you can change the settings of each item from the [PROJECTOR SETUP] menu → [STANDBY MODE].

- 1) Press ▲▼ to select an item.
- 2) Press ◀▶ to switch the setting.

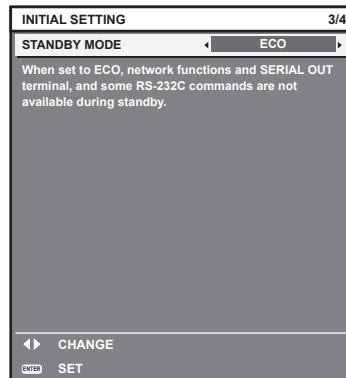

- 3) Press the <ENTER> button to proceed to the initial setting.

## Initial setting (screen setting)

Set the screen format (aspect ratio) and display position of the image. After completed the initial setting, you can change the settings of each item from the [DISPLAY OPTION] menu → [SCREEN SETTING].

- 1) Press ▲▼ to select an item.
- 2) Press ◀▶ to switch the setting.

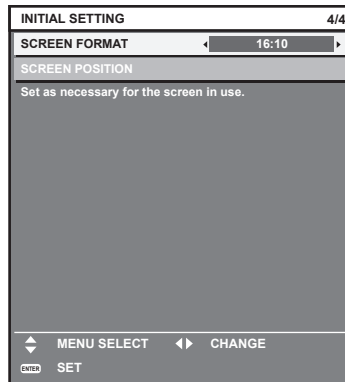

- 3) Press the <ENTER> button.
  - Confirm the setting value and complete the initial setting.

### Note

- If you press the <MENU> button on the initial setting screen, you can go back to the previous screen.
- To continue operations after completed the initial settings, refer to "Selecting the input signal" (▶ page 58).
- By default, the time zone of the projector is set to +09:00 (Japan and Korean Standard Time). Change the setting in the [PROJECTOR SETUP] menu → [DATE AND TIME] → [TIME ZONE] to the time zone of the region where you use the projector.

# About your projector

## Remote control

### ■ Front

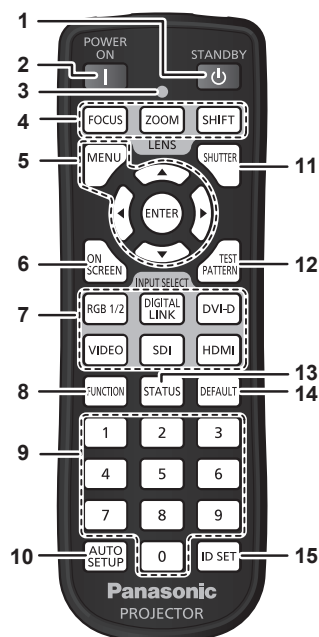

### ■ Top

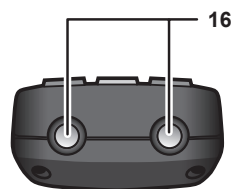

### ■ Bottom

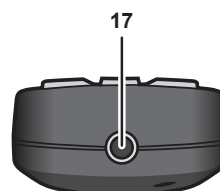

#### 1 Power standby <⏻> button

Sets the projector to the state where the projector is switched off (standby mode) when the <MAIN POWER> switch on the projector is set to <ON> and in projection mode.

#### 2 Power on <⏻> button

Starts projection when the <MAIN POWER> switch on the projector is set to <ON> when the power is switched off (standby mode).

#### 3 Remote control indicator

Flashes if any button in the remote control is pressed.

#### 4 Lens (<FOCUS>, <ZOOM>, <SHIFT>) buttons

Adjusts the projection lens. (➔ page 58)

#### 5 <MENU> button/<ENTER> button/▲▼◀▶ buttons

Used to navigate through the menu screen. (➔ page 65)

#### 6 <ON SCREEN> button

Switches on (display)/off (hide) the on-screen display function. (➔ page 61)

#### 7 Input selection (<RGB1/2>, <DIGITAL LINK>, <DVI-D>, <VIDEO>, <SDI>, <HDMI>) buttons

Switches the input signal to project. (➔ page 62)

#### 8 <FUNCTION> button

Assigns a frequently used operation as a shortcut button. (➔ page 63)

#### 9 Number (<0> - <9>) buttons

Used when the system uses multiple projectors. Used to input ID numbers or passwords.

#### 10 <AUTO SETUP> button

Automatically adjusts the image display position while projecting the image. [PROGRESS] is displayed on the screen while adjusting automatically. (➔ page 63)

#### 11 <SHUTTER> button

Used when temporarily turning off the image. (➔ page 61)

#### 12 <TEST PATTERN> button

Displays the test pattern. (➔ page 63)

#### 13 <STATUS> button

Displays the projector information.

#### 14 <DEFAULT> button

Resets the content of the sub-menu to the factory default. (➔ page 66)

#### 15 <ID SET> button

Sets the ID number of the remote control to use for a system using multiple projectors. (➔ page 29)

#### 16 Remote control signal transmitter

17 Remote control wired terminal  
Connects to the projector with a cable. (➔ page 30)

### Attention

- Do not drop the remote control.
- Avoid contact with liquids or moisture.
- Do not attempt to modify or disassemble the remote control.

### Note

- When operating the remote control by directly pointing the receiver of the projector, operate the remote control at a distance approx. 30 m (98'5") or shorter from the remote control receiving section. The remote control can control at angles of up to  $\pm 30^\circ$  vertically and horizontally, but the effective control range may be reduced.
- If there are any obstacles between the remote control and the remote control signal receiver, the remote control may not operate properly.
- The signal will be reflected off the screen. However, the operating range may be limited from light reflection loss due to the screen material.
- If the remote control signal receiver directly receives strong light, such as fluorescent light, the remote control may not operate properly. Use it in a place distant from the light source.
- The power indicator <ON (G)/STANDBY (R)> will flash if the projector receives a remote control signal.

## Projector body

### ■ Front

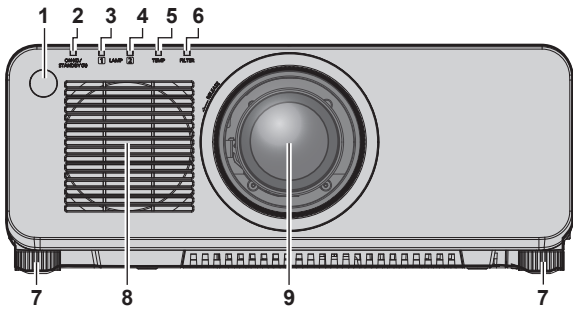

### ■ Rear

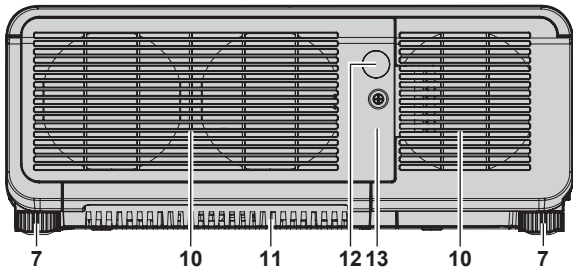

### ■ Side

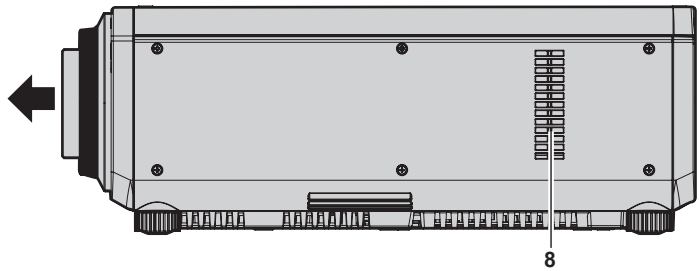
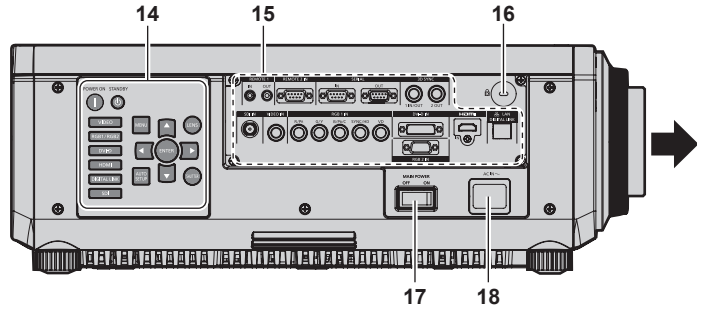

### ■ Bottom

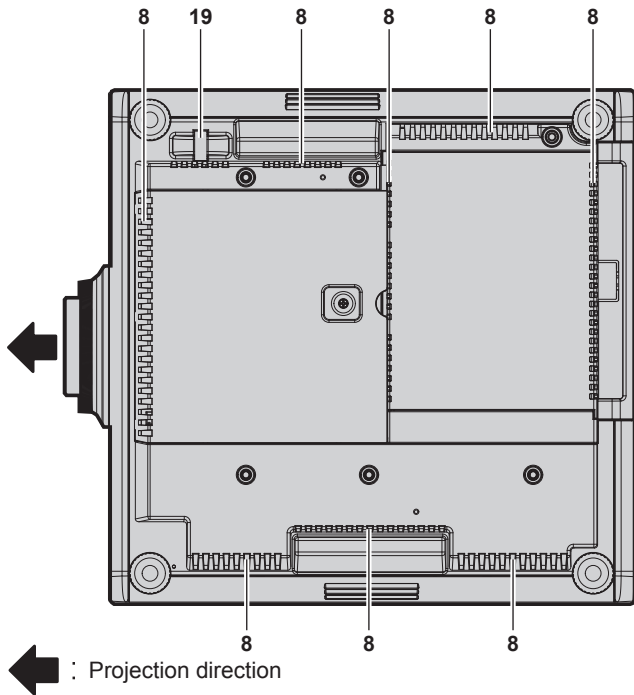

← : Projection direction

## WARNING

Keep your hands and other objects away from the air exhaust port.

- Keep your hands and face away.
- Do not insert your fingers.
- Keep heat-sensitive objects away.

Heated air from the air exhaust port can cause burns, injury, or deformations.

- 1 **Remote control signal receiver (front)**
- 2 **Power indicator <ON (G)/STANDBY (R)>**  
Displays the status of the power.
- 3 **Lamp indicator <LAMP1>**  
Displays the status of lamp 1.
- 4 **Lamp indicator <LAMP2>**  
Displays the status of lamp 2.
- 5 **Temperature indicator <TEMP>**  
Displays the internal temperature status.
- 6 **Filter indicator <FILTER>**  
Displays the status of the air filter case and air filter.
- 7 **Adjustable feet**  
Adjusts the projection angle.
- 8 **Air intake port**
- 9 **Projection lens**  
(Only models with lens)
- 10 **Air exhaust port**
- 11 **Air filter case**
- 12 **Remote control signal receiver (rear)**
- 13 **Lamp unit cover**
- 14 **Control panel** (⇒ page 27)
- 15 **Connecting terminals** (⇒ page 28)

**16 Security slot**

This security slot is compatible with the Kensington security cables.

**17 <MAIN POWER> switch**

Turns on/off the main power.

**18 <AC IN> terminal**

Connect the supplied power cord.

**19 Burglar hook port**

Attaches a burglar prevention cable, etc.

**Attention**

- Do not block the ventilation ports (intake and exhaust) of the projector.

**■ Control panel**

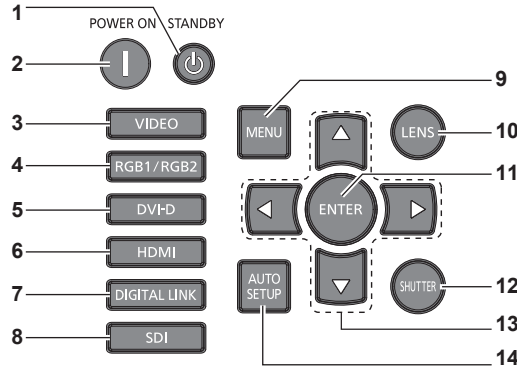

**1 Power standby <⏻> button**

Sets the projector to the state where the projector is switched off (standby mode) when the <MAIN POWER> switch on the projector is set to <ON> and in projection mode.

**2 Power on <|> button**

Starts projection when the <MAIN POWER> switch on the projector is set to <ON> when the power is switched off (standby mode).

**3 <VIDEO> button**

Switches the input to VIDEO.

**4 <RGB1/RGB2> button**

Switches the input to RGB.

**5 <DVI-D> button**

Switches the input to DVI-D.

**6 <HDMI> button**

Switches the input to HDMI.

**7 <DIGITAL LINK> button**

Switches the input to DIGITAL LINK.

**8 <SDI> button**

Switches the input to SDI.  
(Only for PT-DZ870E)

**9 <MENU> button**

Displays or hides the main menu. (➡ page 65)

Returns to the previous menu when a sub-menu is displayed. If you press the <MENU> button on the control panel for at least three seconds while the on-screen display is off, the on-screen display is turned on.

**10 <LENS> button**

Adjusts the focus, zoom, and shift (position) of the lens.

**11 <ENTER> button**

Determines and executes an item in the menu screen.

**12 <SHUTTER> button**

Used when temporarily turning off the image. (➡ page 61)

**13 ▲▼◀▶ buttons**

Use to select items in the menu screen, change settings, and adjust levels. Also used to enter a password in [SECURITY] or enter characters.

**14 <AUTO SETUP> button**

Automatically adjusts the image display position while projecting the image. [PROGRESS] is displayed on the screen during automatic adjustment. (➡ page 63)

■ Connecting terminals

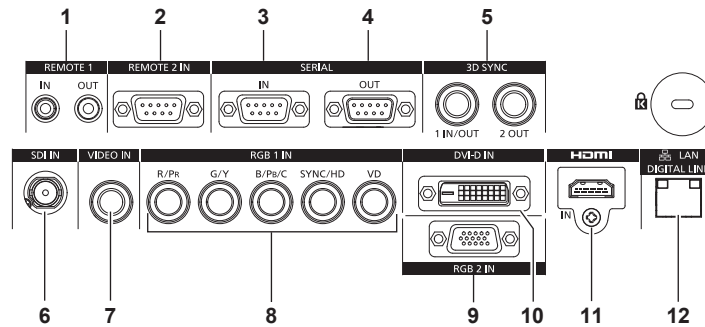

- |  |   |
|--|---|
| <p><b>1 &lt;REMOTE 1 IN&gt; terminal/&lt;REMOTE 1 OUT&gt; terminal</b><br/>These are the terminals to connect the remote control for serial control when the system uses multiple projectors.</p> <p><b>2 &lt;REMOTE 2 IN&gt; terminal</b><br/>This is a terminal to remotely control the projector using the external control circuit.</p> <p><b>3 &lt;SERIAL IN&gt; terminal</b><br/>This is the RS-232C compatible terminal to externally control the projector by connecting a computer.</p> <p><b>4 &lt;SERIAL OUT&gt; terminal</b><br/>This is a terminal to output the signal connected to the &lt;SERIAL IN&gt; terminal.</p> <p><b>5 &lt;3D SYNC 1 IN/OUT&gt; terminal / &lt;3D SYNC 2 OUT&gt; terminal</b><br/>This is a terminal to input or output control signals when using the projector in 3D systems.</p> <p><b>6 &lt;SDI IN&gt; terminal</b><br/>This is the terminal to input SDI signals. (Only for PT-DZ870E)</p> | <p><b>7 &lt;VIDEO IN&gt; terminal</b><br/>This is the terminal to input video signals.</p> <p><b>8 &lt;RGB 1 IN&gt; (&lt;R/P<sub>R</sub>&gt;, &lt;G/Y&gt;, &lt;B/P<sub>B</sub>/C&gt;, &lt;SYNC/HD&gt;, &lt;VD&gt;) terminal</b><br/>This is a terminal to input RGB signals or the YC<sub>B</sub>C<sub>R</sub>/YP<sub>B</sub>P<sub>R</sub> and Y/C signals.</p> <p><b>9 &lt;RGB 2 IN&gt; terminal</b><br/>This is a terminal to input RGB signals or YC<sub>B</sub>C<sub>R</sub>/YP<sub>B</sub>P<sub>R</sub> signals.</p> <p><b>10 &lt;DVI-D IN&gt; terminal</b><br/>This is the terminal to input DVI-D signals.</p> <p><b>11 &lt;HDMI IN&gt; terminal</b><br/>This is the terminal to input HDMI signals.</p> <p><b>12 &lt;DIGITAL LINK/LAN&gt; terminal</b><br/>This is the LAN terminal to connect to the network. This is also used when connecting a video signal transmission device via the LAN terminal.</p> |
|--|---|

**Attention**

- When a LAN cable is directly connected to the projector, the network connection must be made indoors.



# Using the remote control

## Inserting and removing the batteries

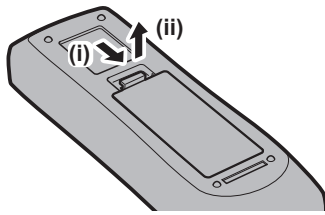

Fig. 1

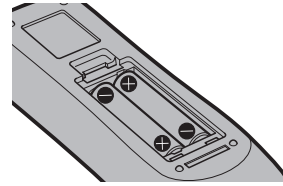

Fig. 2

- 1) **Open the cover. (Fig. 1)**
- 2) **Insert the batteries and close the cover (insert the  $\ominus$  side first). (Fig. 2)**
  - When removing the batteries, perform the steps in reverse order.

## Setting the remote control ID numbers

When you use the system with multiple projectors, you can operate all the projectors simultaneously or each projector individually using single remote control, if a unique ID number is assigned to each projector.

After setting the ID number of the projector, set same ID number on the remote control.

**The factory default ID number of the projector is set to [ALL]. When using a single projector, keep pressing the <ID SET> button on the remote control for at least three seconds to set the ID number of the remote control to [ALL]. In addition, when the ID number of the projector is unknown, setting the ID number to [ALL] enables the remote control.**

### How to set

- 1) **Press the <ID SET> button on the remote control.**
- 2) **Within five seconds, press the two-digit ID number set on the projector using the number (<0> - <9>) buttons.**
  - When the ID number is set to [ALL], you can control the projector regardless of the ID number setting of the projector.

### Attention

- Since the ID number of the remote control can be set without the projector, do not press the <ID SET> button on the remote control carelessly. If the <ID SET> button is pressed and no number (<0> - <9>) buttons are pressed within five seconds, the ID number returns to its original value before the <ID SET> button was pressed.
- The ID number set on the remote control will be stored unless it is set again. However, it will be erased if the remote control is left with dead batteries. Set the same ID number again when the batteries are replaced.

### Note

- When the ID number of the remote control is set to [0], you can control the projector regardless of the ID number setting of the projector, as same as when [ALL] is set.
- Set the ID number of the projector from the [PROJECTOR SETUP] menu → [PROJECTOR ID].

## Connecting to the projector with a cable

When you use the system with multiple projectors, use commercial M3 stereo mini jack cables and connect the other devices to the <REMOTE 1 IN>/<REMOTE 1 OUT> terminals of the projector body.

The remote control is effective even in places where an obstacle stands in the light path or where devices are susceptible to outside light.

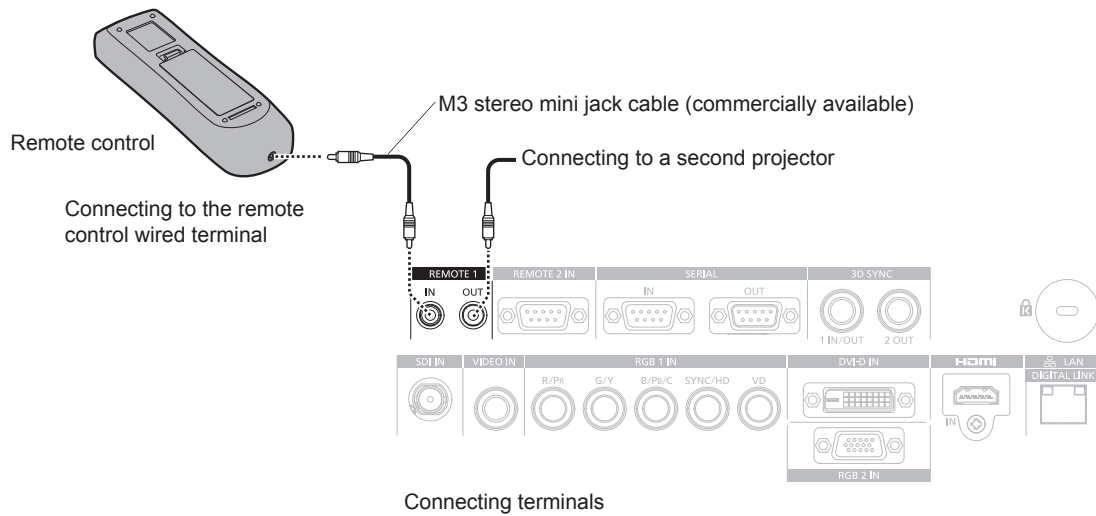

### Attention

- Use a cable that is 15 m (49'3") or shorter, with 2 core shield. The remote control may not operate when the length of the cable exceeds 15 m (49'3") or when the shielding of the cable is inadequate.

# Chapter 2 **Getting Started**

---

This chapter describes things you need to do before using the projector such as the setup and connections.

# Setting up

## Installation mode

There are four ways to set up the projector. Set the [PROJECTOR SETUP] menu → [PROJECTION METHOD] (▶ page 108) depending on the installation location. Set [COOLING CONDITION] to [AUTO]. Using the projector with [COOLING CONDITION] set incorrectly may shorten the life of the lamp.

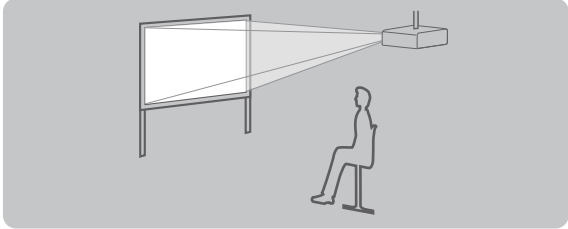
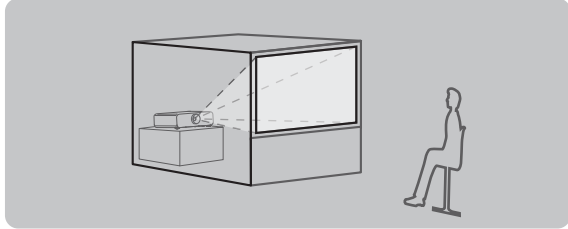
Mounting on the ceiling and projecting forward		Setting on a desk/floor and projecting from rear (Using the translucent screen)	
			
Menu item	Method	Menu item	Method
[PROJECTION METHOD]	[FRONT/CEILING]	[PROJECTION METHOD]	[REAR/FLOOR]
[COOLING CONDITION]	[AUTO]	[COOLING CONDITION]	[AUTO]

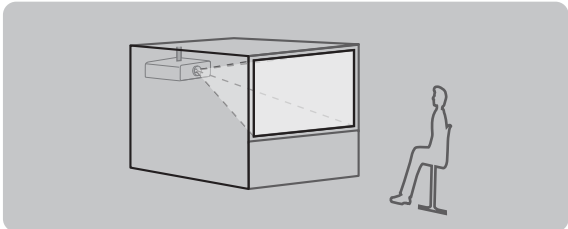
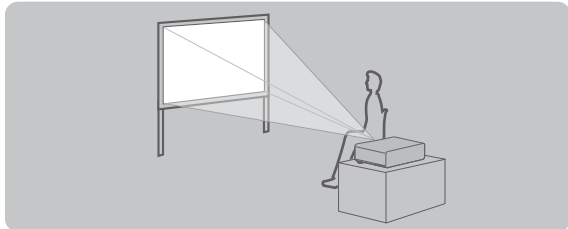
Mounting on the ceiling and projecting from rear (Using the translucent screen)		Setting on a desk/floor and projecting forward	
			
Menu item	Method	Menu item	Method
[PROJECTION METHOD]	[REAR/CEILING]	[PROJECTION METHOD]	[FRONT/FLOOR]
[COOLING CONDITION]	[AUTO]	[COOLING CONDITION]	[AUTO]

## Parts for ceiling mount (optional)

You can install the projector on the ceiling using the optional Ceiling Mount Bracket (Model No.: ET-PKD120H (for high ceilings), ET-PKD120S (for low ceilings), and ET-PKD120B (Projector Mount Bracket)).

- Be sure to use the Ceiling Mount Bracket specified for this projector.
- Refer to the Installation Instructions supplied with the Ceiling Mount Bracket when installing the projector with the bracket.

### Attention

- To ensure projector performance and security, installation of the Ceiling Mount Bracket must be carried out by your dealer or a qualified technician.

## Screen size and throw distance

Refer to the screen size and projection distances to install the projector. Image size and image position can be adjusted in accordance with the screen size and screen position.

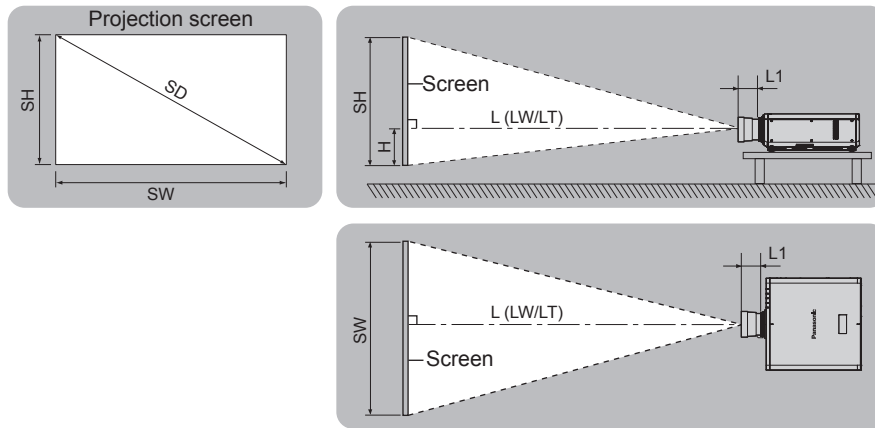

(Unit: m)

L (LW/LT)*1	Projection distance
L1	Lens protrusion dimension
SH	Image height
SW	Image width
H	Distance from the lens center to the lower edge of the image
SD	Image diagonal size

\*1 LW: Minimum projection distance when the Zoom Lens is used  
 LT: Maximum projection distance when the Zoom Lens is used

(Unit: m)

Projection lens Model No.	L1 dimension (approximate value)
Standard lens	0.043
ET-DLE055	0.028
ET-DLE085	0.084
ET-DLE150	0.045
ET-DLE250	0.045
ET-DLE350	0.051
ET-DLE450	0.095

### Attention

- Before setting up, read "Precautions for use" (➔ page 16).
- Do not use the projector and the high-powered laser equipment in the same room. The DLP chips can be damaged if a laser beam hits the projection lens surface.

**[GEOMETRY(2D)] projection range**

(Only for PT-DZ870E)

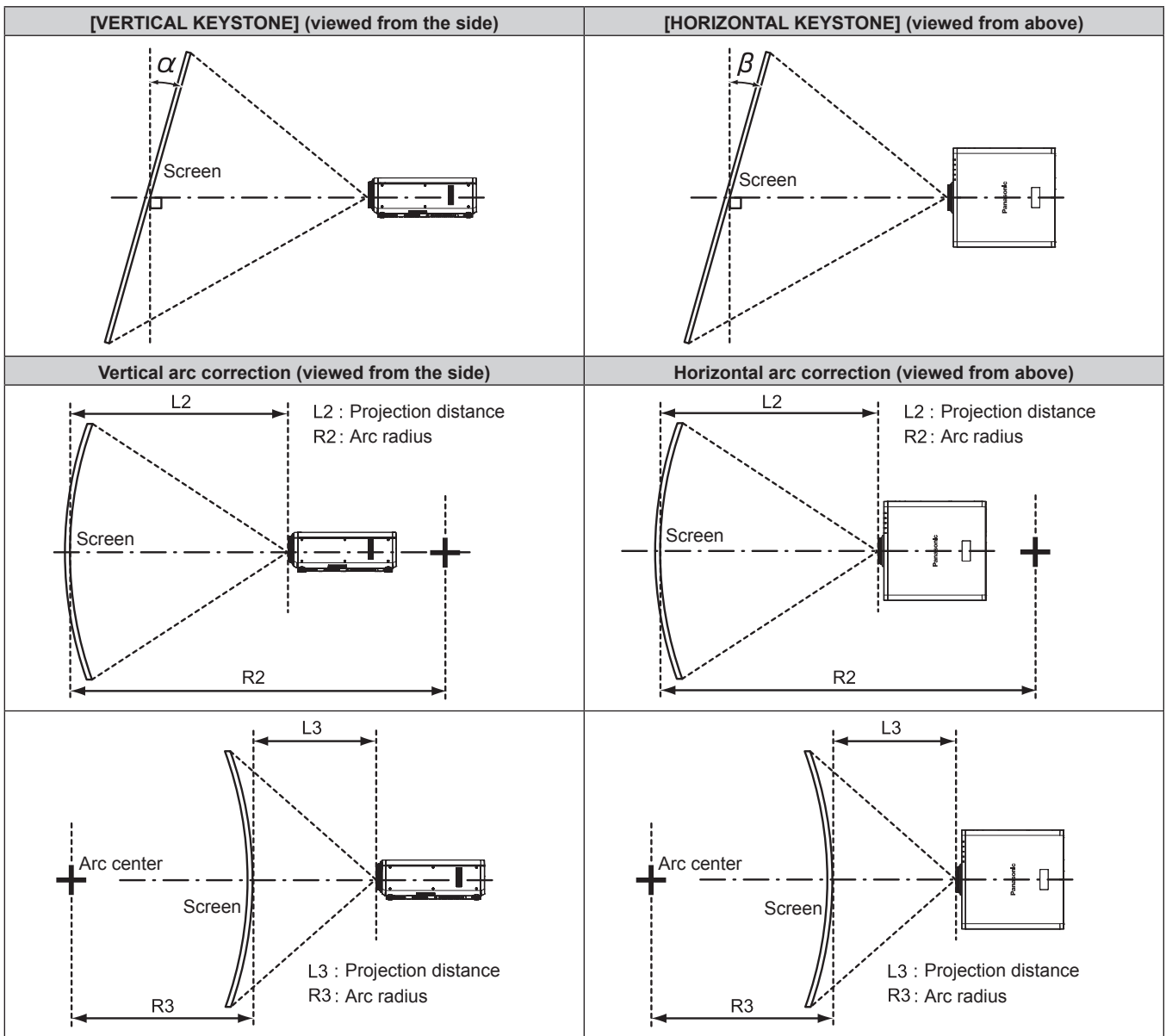

**Standard status**

Projection lens Model No.	Only for [KEYSTONE]		[KEYSTONE] and [CURVED] used together				Only for [CURVED]	
	Vertical keystone correction angle $\alpha$ (°)	Horizontal keystone correction angle $\beta$ (°)	Vertical keystone correction angle $\alpha$ (°)	Horizontal keystone correction angle $\beta$ (°)	Min. value of R2/L2	Min. value of R3/L3	Min. value of R2/L2	Min. value of R3/L3
Standard zoom lens	±40	±15	±20	±15	0.9	1.7	0.5	1
ET-DLE055	±22	±15	±8	±8	1.7	4.3	1	2.6
ET-DLE085	±22	±15	±8	±8	1.7	4.3	1	2.6
ET-DLE150	±40	±15	±20	±15	1.1	2.6	0.6	1.5
ET-DLE250	±40	±15	±20	±15	0.7	1.3	0.4	0.7
ET-DLE350	±40	±15	±20	±15	0.4	0.8	0.3	0.5
ET-DLE450	±40	±15	±20	±15	0.3	0.6	0.2	0.3

When using the optional Upgrade Kit (Model No.: ET-UK20)

Projection lens Model No.	Only for [KEystone]		[KEystone] and [CURVED] used together				Only for [CURVED]	
	Vertical keystone correction angle $\alpha$ (°)	Horizontal keystone correction angle $\beta$ (°)	Vertical keystone correction angle $\alpha$ (°)	Horizontal keystone correction angle $\beta$ (°)	Min. value of R2/L2	Min. value of R3/L3	Min. value of R2/L2	Min. value of R3/L3
Standard zoom lens	±40	±40	±20	±15	0.7	1.3	0.4	0.7
ET-DLE055	±22	±15	±8	±8	1.3	3.3	0.8	1.9
ET-DLE085	±22	±15	±8	±8	1.3	3.3	0.8	1.9
ET-DLE150	±40	±40	±20	±15	0.9	2	0.5	1.1
ET-DLE250	±40	±40	±20	±15	0.5	1	0.3	0.6
ET-DLE350	±45	±40	±20	±15	0.3	0.6	0.2	0.4
ET-DLE450	±45	±40	±20	±15	0.2	0.4	0.2	0.3

\*1 Cannot correct [VERTICAL KEYSTONE] and [HORIZONTAL KEYSTONE] if the total exceeds 55° when used at the same time.

**Note**

- When [GEOMETRY(2D)] is used, the focus of the entire screen may be lost as correction increases.
- Make the curved screen a circular arc shape with one part of a perfect circle removed.
- Adjustment range of the [GEOMETRY(2D)] items may not match the listed projection range depending on the projection lens. Use this projector within the projection range, otherwise the correction may not work.
- [GEOMETRY(2D)] can be selected only when a 2D image is displayed. The setting becomes invalid while a 3D image is displayed. When executing the keystone correction while displaying a 3D image, set with [KEYSTONE(3D)]. However, if [3D SYSTEM SETTING] is set to [DUAL (LEFT)] or [DUAL (RIGHT)], the keystone correction becomes possible by selecting [GEOMETRY(2D)] even during the 3D image display.

**Projection distance of each projection lens**

A ±5 % error in listed projection distances may occur.

In addition, when [GEOMETRY(2D)] and [KEYSTONE] are used, distance is corrected to become smaller than the specified screen size.

**For PT-DZ870E**

■ **When the screen aspect is 16:10**

(Unit: m)

Lens type			Standard zoom lens		Optional lens						
					Fixed-focus lens	Ultra short focus zoom lens		Short focus zoom lens		Intermediate focus zoom lens	
Projection lens Model No.			—		ET-DLE055	ET-DLE085		ET-DLE150		ET-DLE250	
Throw ratio*1			1.7-2.4:1		0.8:1	0.8-1.0:1		1.3-1.9:1		2.3-3.6:1	
Projection screen size			Projection distance (L)								
Diagonal (SD)	Height (SH)	Width (SW)	Min. (LW)	Max. (LT)	Fixed	Min. (LW)	Max. (LT)	Min. (LW)	Max. (LT)	Min. (LW)	Max. (LT)
1.27 (50")	0.673	1.077	1.82	2.57	0.83	0.82	1.04	1.38	2.01	2.42	3.87
1.52 (60")	0.808	1.292	2.20	3.10	1.00	1.00	1.25	1.66	2.43	2.92	4.65
1.78 (70")	0.942	1.508	2.58	3.63	1.18	1.17	1.47	1.95	2.84	3.42	5.44
2.03 (80")	1.077	1.723	2.95	4.16	1.35	1.35	1.68	2.23	3.25	3.92	6.23
2.29 (90")	1.212	1.939	3.33	4.69	1.53	1.52	1.90	2.52	3.66	4.42	7.02
2.54 (100")	1.346	2.154	3.71	5.21	1.70	1.70	2.11	2.81	4.08	4.92	7.81
3.05 (120")	1.615	2.585	4.47	6.27	2.05	2.05	2.55	3.38	4.90	5.91	9.39
3.81 (150")	2.019	3.231	5.60	7.86	2.58	2.57	3.19	4.24	6.14	7.41	11.75
5.08 (200")	2.692	4.308	7.50	10.50	3.45	3.44	4.27	5.67	8.20	9.91	15.70
6.35 (250")	3.365	5.385	9.39	13.14	—	4.31	5.35	7.10	10.26	12.41	19.64
7.62 (300")	4.039	6.462	11.28	15.79	—	5.18	6.43	8.53	12.33	14.91	23.59
8.89 (350")	4.712	7.539	13.18	18.43	—	6.06	7.51	9.96	14.39	17.40	27.53
10.16 (400")	5.385	8.616	15.07	21.07	—	6.93	8.59	11.39	16.45	19.90	31.48
12.70 (500")	6.731	10.770	18.86	26.36	—	8.67	10.75	14.25	20.58	24.90	39.37
15.24 (600")	8.077	12.923	22.64	31.65	—	10.42	12.91	17.11	24.70	29.89	47.25

Lens type			Optional lens				Height position (H) <sup>2</sup>	
			Long focus zoom lens		Ultra long focus zoom lens			
Projection lens Model No.			ET-DLE350		ET-DLE450		Standard zoom lens/ET-DLE085/ ET-DLE150/ ET-DLE250/ ET-DLE350/ ET-DLE450	ET-DLE055 (Fixed)
Throw ratio*1			3.6-5.4:1		5.4-8.6:1			
Projection screen size			Projection distance (L)					
Diagonal (SD)	Height (SH)	Width (SW)	Min. (LW)	Max. (LT)	Min. (LW)	Max. (LT)		
1.27 (50")	0.673	1.077	3.80	5.81	5.66	9.12	0 - 0.34	0.34
1.52 (60")	0.808	1.292	4.59	7.00	6.85	11.01	0 - 0.40	0.40
1.78 (70")	0.942	1.508	5.38	8.19	8.04	12.89	0 - 0.47	0.47
2.03 (80")	1.077	1.723	6.16	9.38	9.23	14.78	0 - 0.54	0.54
2.29 (90")	1.212	1.939	6.95	10.57	10.43	16.66	0 - 0.61	0.61
2.54 (100")	1.346	2.154	7.74	11.76	11.62	18.55	0 - 0.67	0.67
3.05 (120")	1.615	2.585	9.31	14.14	14.00	22.31	0 - 0.81	0.81
3.81 (150")	2.019	3.231	11.68	17.71	17.58	27.97	0 - 1.01	1.01
5.08 (200")	2.692	4.308	15.61	23.66	23.54	37.39	0 - 1.35	1.35
6.35 (250")	3.365	5.385	19.55	29.61	29.50	46.81	0 - 1.68	—
7.62 (300")	4.039	6.462	23.49	35.56	35.46	56.24	0 - 2.02	—
8.89 (350")	4.712	7.539	27.42	41.51	41.42	65.66	0 - 2.36	—
10.16 (400")	5.385	8.616	31.36	47.46	47.38	75.08	0 - 2.69	—
12.70 (500")	6.731	10.770	39.23	59.36	59.30	93.93	0 - 3.37	—
15.24 (600")	8.077	12.923	47.11	71.25	71.22	112.77	0 - 4.04	—

\*1 The throw ratio is based on the value during projection onto a 2.03 m (80") screen size.

\*2 When the fixed-focus lens (Model No.: ET-DLE055) is attached, the lens shift is not possible. Therefore, the height position (H) becomes SH/2.



■ When the screen aspect is 16:9

(Unit: m)

Lens type			Standard zoom lens		Optional lens						
					Fixed-focus lens	Ultra short focus zoom lens		Short focus zoom lens		Intermediate focus zoom lens	
Projection lens Model No.			—		ET-DLE055	ET-DLE085		ET-DLE150		ET-DLE250	
Throw ratio*1			1.7-2.4:1		0.8:1	0.8-1.0:1		1.3-1.9:1		2.3-3.6:1	
Projection screen size			Projection distance (L)								
Diagonal (SD)	Height (SH)	Width (SW)	Min. (LW)	Max. (LT)	Fixed	Min. (LW)	Max. (LT)	Min. (LW)	Max. (LT)	Min. (LW)	Max. (LT)
1.27 (50")	0.623	1.107	1.87	2.64	0.85	0.85	1.07	1.42	2.07	2.49	3.97
1.52 (60")	0.747	1.328	2.26	3.19	1.03	1.03	1.29	1.71	2.49	3.00	4.79
1.78 (70")	0.872	1.550	2.65	3.73	1.21	1.21	1.51	2.00	2.92	3.51	5.60
2.03 (80")	0.996	1.771	3.04	4.27	1.39	1.39	1.73	2.30	3.34	4.03	6.41
2.29 (90")	1.121	1.992	3.43	4.82	1.57	1.57	1.95	2.59	3.77	4.54	7.22
2.54 (100")	1.245	2.214	3.82	5.36	1.75	1.75	2.17	2.89	4.19	5.05	8.03
3.05 (120")	1.494	2.657	4.60	6.45	2.11	2.10	2.62	3.47	5.04	6.08	9.65
3.81 (150")	1.868	3.321	5.76	8.08	2.65	2.64	3.28	4.36	6.31	7.62	12.08
5.08 (200")	2.491	4.428	7.71	10.80	3.55	3.54	4.39	5.82	8.43	10.19	16.14
6.35 (250")	3.113	5.535	9.65	13.51	—	4.43	5.50	7.29	10.55	12.75	20.19
7.62 (300")	3.736	6.641	11.60	16.23	—	5.33	6.61	8.76	12.67	15.32	24.25
8.89 (350")	4.358	7.748	13.55	18.95	—	6.23	7.72	10.23	14.79	17.89	28.30
10.16 (400")	4.981	8.855	15.49	21.66	—	7.12	8.83	11.70	16.91	20.46	32.35
12.70 (500")	6.226	11.069	19.38	27.10	—	8.91	11.05	14.64	21.15	25.59	40.46
15.24 (600")	7.472	13.283	23.27	32.53	—	10.71	13.27	17.58	25.39	30.72	48.57

Lens type			Optional lens				Height position (H) <sup>2</sup>	
			Long focus zoom lens		Ultra long focus zoom lens			
Projection lens Model No.			ET-DLE350		ET-DLE450		Standard zoom lens/ET-DLE085/ ET-DLE150/ ET-DLE250/ ET-DLE350/ ET-DLE450	ET-DLE055 (Fixed)
Throw ratio*1			3.6-5.4:1		5.4-8.6:1			
Projection screen size			Projection distance (L)					
Diagonal (SD)	Height (SH)	Width (SW)	Min. (LW)	Max. (LT)	Min. (LW)	Max. (LT)		
1.27 (50")	0.623	1.107	3.91	5.98	5.82	9.39	-0.06 - 0.31	0.31
1.52 (60")	0.747	1.328	4.72	7.20	7.05	11.32	-0.07 - 0.37	0.37
1.78 (70")	0.872	1.550	5.53	8.43	8.27	13.26	-0.09 - 0.44	0.44
2.03 (80")	0.996	1.771	6.34	9.65	9.50	15.20	-0.10 - 0.50	0.50
2.29 (90")	1.121	1.992	7.15	10.87	10.72	17.13	-0.11 - 0.56	0.56
2.54 (100")	1.245	2.214	7.96	12.09	11.95	19.07	-0.12 - 0.62	0.62
3.05 (120")	1.494	2.657	9.58	14.54	14.40	22.94	-0.15 - 0.75	0.75
3.81 (150")	1.868	3.321	12.00	18.21	18.08	28.75	-0.19 - 0.93	0.93
5.08 (200")	2.491	4.428	16.05	24.32	24.20	38.44	-0.25 - 1.25	1.25
6.35 (250")	3.113	5.535	20.10	30.44	30.33	48.12	-0.31 - 1.56	—
7.62 (300")	3.736	6.641	24.14	36.55	36.45	57.81	-0.37 - 1.87	—
8.89 (350")	4.358	7.748	28.19	42.67	42.58	67.49	-0.44 - 2.18	—
10.16 (400")	4.981	8.855	32.24	48.78	48.71	77.18	-0.50 - 2.49	—
12.70 (500")	6.226	11.069	40.33	61.01	60.96	96.55	-0.62 - 3.11	—
15.24 (600")	7.472	13.283	48.42	73.24	73.21	115.91	-0.75 - 3.74	—

\*1 The throw ratio is based on the value during projection onto a 2.03 m (80") screen size.

\*2 When the fixed-focus lens (Model No.: ET-DLE055) is attached, the lens shift is not possible. The height position (H) becomes SH/2.

■ When the screen aspect is 4:3

(Unit: m)

Lens type			Standard zoom lens		Optional lens						
					Fixed-focus lens	Ultra short focus zoom lens		Short focus zoom lens		Intermediate focus zoom lens	
Projection lens Model No.			—		ET-DLE055	ET-DLE085		ET-DLE150		ET-DLE250	
Throw ratio*1			2.1-2.9:1		0.9:1	0.9-1.2:1		1.6-2.3:1		2.7-4.3:1	
Projection screen size			Projection distance (L)								
Diagonal (SD)	Height (SH)	Width (SW)	Min. (LW)	Max. (LT)	Fixed	Min. (LW)	Max. (LT)	Min. (LW)	Max. (LT)	Min. (LW)	Max. (LT)
1.27 (50")	0.762	1.016	2.07	2.92	0.94	0.94	1.18	1.56	2.29	2.75	4.39
1.52 (60")	0.914	1.219	2.50	3.52	1.14	1.14	1.42	1.89	2.75	3.31	5.28
1.78 (70")	1.067	1.422	2.93	4.12	1.34	1.33	1.67	2.21	3.22	3.88	6.17
2.03 (80")	1.219	1.626	3.35	4.72	1.54	1.53	1.91	2.54	3.69	4.44	7.07
2.29 (90")	1.372	1.829	3.78	5.31	1.74	1.73	2.16	2.86	4.15	5.01	7.96
2.54 (100")	1.524	2.032	4.21	5.91	1.93	1.93	2.40	3.18	4.62	5.57	8.85
3.05 (120")	1.829	2.438	5.07	7.11	2.33	2.32	2.89	3.83	5.55	6.71	10.64
3.81 (150")	2.286	3.048	6.35	8.91	2.93	2.91	3.62	4.80	6.96	8.40	13.32
5.08 (200")	3.048	4.064	8.50	11.90	3.92	3.90	4.84	6.42	9.29	11.23	17.78
6.35 (250")	3.810	5.080	10.64	14.89	—	4.89	6.07	8.04	11.63	14.06	22.25
7.62 (300")	4.572	6.096	12.78	17.88	—	5.88	7.29	9.66	13.96	16.88	26.71
8.89 (350")	5.334	7.112	14.93	20.88	—	6.86	8.51	11.28	16.30	19.71	31.18
10.16 (400")	6.096	8.128	17.07	23.87	—	7.85	9.73	12.90	18.63	22.54	35.64
12.70 (500")	7.620	10.160	21.36	29.85	—	9.82	12.17	16.13	23.30	28.19	44.58
15.24 (600")	9.144	12.192	25.64	35.84	—	11.80	14.62	19.37	27.97	33.85	53.51

Lens type			Optional lens				Height position (H) <sup>*2</sup>	
			Long focus zoom lens		Ultra long focus zoom lens			
Projection lens Model No.			ET-DLE350		ET-DLE450		Standard zoom lens/ET-DLE085/ ET-DLE150/ ET-DLE250/ ET-DLE350/ ET-DLE450	ET-DLE055 (Fixed)
Throw ratio*1			4.3-6.5:1		6.5-10.3:1			
Projection screen size			Projection distance (L)					
Diagonal (SD)	Height (SH)	Width (SW)	Min. (LW)	Max. (LT)	Min. (LW)	Max. (LT)		
1.27 (50")	0.762	1.016	4.32	6.60	6.45	10.37	0 - 0.38	0.38
1.52 (60")	0.914	1.219	5.21	7.95	7.80	12.50	0 - 0.46	0.46
1.78 (70")	1.067	1.422	6.10	9.29	9.14	14.63	0 - 0.53	0.53
2.03 (80")	1.219	1.626	7.00	10.64	10.49	16.77	0 - 0.61	0.61
2.29 (90")	1.372	1.829	7.89	11.99	11.84	18.90	0 - 0.69	0.69
2.54 (100")	1.524	2.032	8.78	13.34	13.19	21.03	0 - 0.76	0.76
3.05 (120")	1.829	2.438	10.56	16.03	15.89	25.30	0 - 0.91	0.91
3.81 (150")	2.286	3.048	13.24	20.07	19.94	31.70	0 - 1.14	1.14
5.08 (200")	3.048	4.064	17.69	26.80	26.69	42.37	0 - 1.52	1.52
6.35 (250")	3.810	5.080	22.15	33.54	33.44	53.04	0 - 1.91	—
7.62 (300")	4.572	6.096	26.61	40.27	40.18	63.70	0 - 2.29	—
8.89 (350")	5.334	7.112	31.06	47.01	46.93	74.37	0 - 2.67	—
10.16 (400")	6.096	8.128	35.52	53.74	53.68	85.04	0 - 3.05	—
12.70 (500")	7.620	10.160	44.43	67.21	67.17	106.37	0 - 3.81	—
15.24 (600")	9.144	12.192	53.35	80.68	80.67	127.70	0 - 4.57	—

\*1 The throw ratio is based on the value during projection onto a 2.03 m (80") screen size.

\*2 When the fixed-focus lens (Model No.: ET-DLE055) is attached, the lens shift is not possible. The height position (H) becomes SH/2.

For PT-DW830E

■ When the screen aspect is 16:10

(Unit: m)

Lens type			Standard zoom lens		Optional lens						
					Fixed-focus lens	Ultra short focus zoom lens		Short focus zoom lens		Intermediate focus zoom lens	
Projection lens Model No.			—		ET-DLE055	ET-DLE085		ET-DLE150		ET-DLE250	
Throw ratio*1			1.8-2.5:1		0.8:1	0.8-1.0:1		1.4-2.0:1		2.4-3.8:1	
Projection screen size			Projection distance (L)								
Diagonal (SD)	Height (SH)	Width (SW)	Min. (LW)	Max. (LT)	Fixed	Min. (LW)	Max. (LT)	Min. (LW)	Max. (LT)	Min. (LW)	Max. (LT)
1.27 (50")	0.673	1.077	1.91	2.70	0.87	0.87	1.09	1.45	2.12	2.54	4.06
1.52 (60")	0.808	1.292	2.31	3.26	1.06	1.05	1.32	1.75	2.55	3.07	4.89
1.78 (70")	0.942	1.508	2.71	3.81	1.24	1.23	1.54	2.05	2.98	3.59	5.72
2.03 (80")	1.077	1.723	3.11	4.37	1.42	1.42	1.77	2.35	3.42	4.12	6.55
2.29 (90")	1.212	1.939	3.50	4.92	1.61	1.60	2.00	2.65	3.85	4.64	7.38
2.54 (100")	1.346	2.154	3.90	5.48	1.79	1.78	2.22	2.95	4.28	5.16	8.20
3.05 (120")	1.615	2.585	4.70	6.59	2.16	2.15	2.68	3.55	5.15	6.21	9.86
3.81 (150")	2.019	3.231	5.89	8.25	2.71	2.70	3.36	4.45	6.45	7.79	12.35
5.08 (200")	2.692	4.308	7.88	11.03	3.63	3.61	4.49	5.95	8.61	10.41	16.49
6.35 (250")	3.365	5.385	9.86	13.81	—	4.53	5.62	7.45	10.78	13.03	20.63
7.62 (300")	4.039	6.462	11.85	16.58	—	5.45	6.76	8.95	12.95	15.65	24.77
8.89 (350")	4.712	7.539	13.84	19.36	—	6.36	7.89	10.46	15.11	18.28	28.91
10.16 (400")	5.385	8.616	15.83	22.13	—	7.28	9.02	11.96	17.28	20.90	33.05
12.70 (500")	6.731	10.770	19.80	27.68	—	9.11	11.29	14.96	21.61	26.14	41.34
15.24 (600")	8.077	12.923	23.78	33.23	—	10.94	13.55	17.96	25.94	31.39	49.62

Lens type			Optional lens				Height position (H) <sup>2</sup>	
			Long focus zoom lens		Ultra long focus zoom lens			
Projection lens Model No.			ET-DLE350		ET-DLE450		Standard zoom lens/ET-DLE085/ ET-DLE150/ ET-DLE250/ ET-DLE350/ ET-DLE450	ET-DLE055 (Fixed)
Throw ratio*1			3.8-5.7:1		5.6-9.0:1			
Projection screen size			Projection distance (L)					
Diagonal (SD)	Height (SH)	Width (SW)	Min. (LW)	Max. (LT)	Min. (LW)	Max. (LT)		
1.27 (50")	0.673	1.077	4.00	6.11	5.96	9.59	-0.07 - 0.34	0.34
1.52 (60")	0.808	1.292	4.83	7.36	7.21	11.57	-0.08 - 0.40	0.40
1.78 (70")	0.942	1.508	5.65	8.61	8.46	13.55	-0.09 - 0.47	0.47
2.03 (80")	1.077	1.723	6.48	9.86	9.71	15.53	-0.11 - 0.54	0.54
2.29 (90")	1.212	1.939	7.31	11.11	10.96	17.51	-0.12 - 0.61	0.61
2.54 (100")	1.346	2.154	8.13	12.36	12.21	19.49	-0.13 - 0.67	0.67
3.05 (120")	1.615	2.585	9.79	14.86	14.72	23.45	-0.16 - 0.81	0.81
3.81 (150")	2.019	3.231	12.27	18.61	18.47	29.38	-0.20 - 1.01	1.01
5.08 (200")	2.692	4.308	16.40	24.85	24.73	39.28	-0.27 - 1.35	1.35
6.35 (250")	3.365	5.385	20.53	31.10	30.99	49.17	-0.34 - 1.68	—
7.62 (300")	4.039	6.462	24.67	37.34	37.25	59.06	-0.40 - 2.02	—
8.89 (350")	4.712	7.539	28.80	43.59	43.51	68.96	-0.47 - 2.36	—
10.16 (400")	5.385	8.616	32.94	49.84	49.76	78.85	-0.54 - 2.69	—
12.70 (500")	6.731	10.770	41.20	62.33	62.28	98.64	-0.67 - 3.37	—
15.24 (600")	8.077	12.923	49.47	74.82	74.80	118.42	-0.81 - 4.04	—

\*1 The throw ratio is based on the value during projection onto a 2.03 m (80") screen size.

\*2 When the fixed-focus lens (Model No.: ET-DLE055) is attached, the lens shift is not possible. The height position (H) becomes SH/2.

■ When the screen aspect is 16:9

(Unit: m)

Lens type			Standard zoom lens		Optional lens						
					Fixed-focus lens	Ultra short focus zoom lens		Short focus zoom lens		Intermediate focus zoom lens	
Projection lens Model No.			—		ET-DLE055	ET-DLE085		ET-DLE150		ET-DLE250	
Throw ratio*1			1.8-2.5:1		0.8:1	0.8-1.0:1		1.4-2.0:1		2.4-3.8:1	
Projection screen size			Projection distance (L)								
Diagonal (SD)	Height (SH)	Width (SW)	Min. (LW)	Max. (LT)	Fixed	Min. (LW)	Max. (LT)	Min. (LW)	Max. (LT)	Min. (LW)	Max. (LT)
1.27 (50")	0.623	1.107	1.97	2.78	0.90	0.89	1.12	1.49	2.18	2.62	4.18
1.52 (60")	0.747	1.328	2.38	3.35	1.09	1.08	1.35	1.80	2.62	3.15	5.03
1.78 (70")	0.872	1.550	2.79	3.92	1.27	1.27	1.59	2.11	3.07	3.69	5.88
2.03 (80")	0.996	1.771	3.19	4.49	1.46	1.46	1.82	2.42	3.51	4.23	6.73
2.29 (90")	1.121	1.992	3.60	5.06	1.65	1.65	2.05	2.72	3.96	4.77	7.58
2.54 (100")	1.245	2.214	4.01	5.63	1.84	1.83	2.29	3.03	4.40	5.31	8.43
3.05 (120")	1.494	2.657	4.83	6.77	2.22	2.21	2.75	3.65	5.29	6.39	10.14
3.81 (150")	1.868	3.321	6.05	8.49	2.79	2.78	3.45	4.58	6.63	8.01	12.69
5.08 (200")	2.491	4.428	8.10	11.34	3.73	3.72	4.61	6.12	8.86	10.70	16.95
6.35 (250")	3.113	5.535	10.14	14.19	—	4.66	5.78	7.66	11.08	13.40	21.21
7.62 (300")	3.736	6.641	12.18	17.04	—	5.60	6.94	9.21	13.31	16.09	25.46
8.89 (350")	4.358	7.748	14.23	19.90	—	6.54	8.11	10.75	15.53	18.79	29.72
10.16 (400")	4.981	8.855	16.27	22.75	—	7.48	9.27	12.29	17.76	21.48	33.98
12.70 (500")	6.226	11.069	20.35	28.45	—	9.36	11.60	15.38	22.21	26.87	42.49
15.24 (600")	7.472	13.283	24.44	34.16	—	11.24	13.93	18.46	26.66	32.26	51.00

Lens type			Optional lens				Height position (H) <sup>2</sup>	
			Long focus zoom lens		Ultra long focus zoom lens			
Projection lens Model No.			ET-DLE350		ET-DLE450		Standard zoom lens/ET-DLE085/ ET-DLE150/ ET-DLE250/ ET-DLE350/ ET-DLE450	ET-DLE055 (Fixed)
Throw ratio*1			3.8-5.7:1		5.6-9.0:1			
Projection screen size			Projection distance (L)					
Diagonal (SD)	Height (SH)	Width (SW)	Min. (LW)	Max. (LT)	Min. (LW)	Max. (LT)		
1.27 (50")	0.623	1.107	4.11	6.29	6.13	9.87	-0.14 - 0.31	0.31
1.52 (60")	0.747	1.328	4.96	7.57	7.42	11.90	-0.16 - 0.37	0.37
1.78 (70")	0.872	1.550	5.81	8.85	8.70	13.94	-0.19 - 0.44	0.44
2.03 (80")	0.996	1.771	6.66	10.14	9.99	15.97	-0.22 - 0.50	0.50
2.29 (90")	1.121	1.992	7.51	11.42	11.28	18.00	-0.25 - 0.56	0.56
2.54 (100")	1.245	2.214	8.36	12.71	12.56	20.04	-0.27 - 0.62	0.62
3.05 (120")	1.494	2.657	10.06	15.27	15.14	24.11	-0.33 - 0.75	0.75
3.81 (150")	1.868	3.321	12.61	19.13	18.99	30.21	-0.41 - 0.93	0.93
5.08 (200")	2.491	4.428	16.86	25.55	25.43	40.38	-0.55 - 1.25	1.25
6.35 (250")	3.113	5.535	21.11	31.97	31.86	50.54	-0.68 - 1.56	—
7.62 (300")	3.736	6.641	25.36	38.39	38.29	60.71	-0.82 - 1.87	—
8.89 (350")	4.358	7.748	29.61	44.81	44.72	70.88	-0.96 - 2.18	—
10.16 (400")	4.981	8.855	33.86	51.23	51.16	81.05	-1.10 - 2.49	—
12.70 (500")	6.226	11.069	42.35	64.07	64.02	101.39	-1.37 - 3.11	—
15.24 (600")	7.472	13.283	50.85	76.91	76.88	121.73	-1.64 - 3.74	—

\*1 The throw ratio is based on the value during projection onto a 2.03 m (80") screen size.

\*2 When the fixed-focus lens (Model No.: ET-DLE055) is attached, the lens shift is not possible. The height position (H) becomes SH/2.

■ When the screen aspect is 4:3

(Unit: m)

Lens type			Standard zoom lens		Optional lens						
					Fixed-focus lens	Ultra short focus zoom lens		Short focus zoom lens		Intermediate focus zoom lens	
Projection lens Model No.			—		ET-DLE055	ET-DLE085		ET-DLE150		ET-DLE250	
Throw ratio*1			2.2-3.0:1		1.0:1	1.0-1.2:1		1.6-2.4:1		2.9-4.6:1	
Projection screen size			Projection distance (L)								
Diagonal (SD)	Height (SH)	Width (SW)	Min. (LW)	Max. (LT)	Fixed	Min. (LW)	Max. (LT)	Min. (LW)	Max. (LT)	Min. (LW)	Max. (LT)
1.27 (50")	0.762	1.016	2.18	3.07	0.99	0.99	1.24	1.65	2.40	2.89	4.61
1.52 (60")	0.914	1.219	2.63	3.70	1.20	1.20	1.50	1.99	2.89	3.48	5.55
1.78 (70")	1.067	1.422	3.08	4.33	1.41	1.40	1.75	2.33	3.38	4.08	6.48
2.03 (80")	1.219	1.626	3.53	4.95	1.62	1.61	2.01	2.67	3.87	4.67	7.42
2.29 (90")	1.372	1.829	3.98	5.58	1.82	1.82	2.26	3.00	4.36	5.26	8.36
2.54 (100")	1.524	2.032	4.42	6.21	2.03	2.03	2.52	3.34	4.85	5.86	9.30
3.05 (120")	1.829	2.438	5.32	7.47	2.45	2.44	3.03	4.02	5.83	7.04	11.17
3.81 (150")	2.286	3.048	6.67	9.35	3.07	3.06	3.80	5.04	7.31	8.82	13.98
5.08 (200")	3.048	4.064	8.92	12.49	4.11	4.10	5.09	6.74	9.76	11.79	18.67
6.35 (250")	3.810	5.080	11.17	15.64	—	5.13	6.37	8.44	12.21	14.76	23.36
7.62 (300")	4.572	6.096	13.42	18.78	—	6.17	7.65	10.14	14.66	17.73	28.05
8.89 (350")	5.334	7.112	15.67	21.92	—	7.21	8.93	11.84	17.11	20.70	32.74
10.16 (400")	6.096	8.128	17.92	25.06	—	8.24	10.22	13.54	19.56	23.67	37.42
12.70 (500")	7.620	10.160	22.42	31.34	—	10.31	12.78	16.94	24.47	29.60	46.80
15.24 (600")	9.144	12.192	26.92	37.63	—	12.39	15.35	20.34	29.37	35.54	56.17

Lens type			Optional lens				Height position (H) <sup>*2</sup>	
			Long focus zoom lens		Ultra long focus zoom lens			
Projection lens Model No.			ET-DLE350		ET-DLE450		Standard zoom lens/ET-DLE085/ ET-DLE150/ ET-DLE250/ ET-DLE350/ ET-DLE450	ET-DLE055 (Fixed)
Throw ratio*1			4.5-6.9:1		6.8-10.8:1			
Projection screen size			Projection distance (L)					
Diagonal (SD)	Height (SH)	Width (SW)	Min. (LW)	Max. (LT)	Min. (LW)	Max. (LT)		
1.27 (50")	0.762	1.016	4.54	6.94	6.78	10.90	-0.08 - 0.38	0.38
1.52 (60")	0.914	1.219	5.48	8.35	8.20	13.14	-0.09 - 0.46	0.46
1.78 (70")	1.067	1.422	6.42	9.76	9.61	15.38	-0.11 - 0.53	0.53
2.03 (80")	1.219	1.626	7.35	11.18	11.03	17.62	-0.12 - 0.61	0.61
2.29 (90")	1.372	1.829	8.29	12.59	12.45	19.86	-0.14 - 0.69	0.69
2.54 (100")	1.524	2.032	9.22	14.01	13.87	22.10	-0.15 - 0.76	0.76
3.05 (120")	1.829	2.438	11.09	16.83	16.70	26.58	-0.18 - 0.91	0.91
3.81 (150")	2.286	3.048	13.90	21.08	20.95	33.30	-0.23 - 1.14	1.14
5.08 (200")	3.048	4.064	18.58	28.15	28.03	44.49	-0.30 - 1.52	1.52
6.35 (250")	3.810	5.080	23.26	35.22	35.12	55.69	-0.38 - 1.91	—
7.62 (300")	4.572	6.096	27.94	42.29	42.20	66.89	-0.46 - 2.29	—
8.89 (350")	5.334	7.112	32.62	49.36	49.28	78.09	-0.53 - 2.67	—
10.16 (400")	6.096	8.128	37.30	56.43	56.37	89.29	-0.61 - 3.05	—
12.70 (500")	7.620	10.160	46.65	70.57	70.53	111.68	-0.76 - 3.81	—
15.24 (600")	9.144	12.192	56.01	84.71	84.70	134.08	-0.91 - 4.57	—

\*1 The throw ratio is based on the value during projection onto a 2.03 m (80") screen size.

\*2 When the fixed-focus lens (Model No.: ET-DLE055) is attached, the lens shift is not possible. The height position (H) becomes SH/2.

For PT-DX100E

■ When the screen aspect is 4:3

(Unit: m)

Lens type			Standard zoom lens		Optional lens						
					Fixed-focus lens	Ultra short focus zoom lens		Short focus zoom lens		Intermediate focus zoom lens	
Projection lens Model No.			—		ET-DLE055	ET-DLE085		ET-DLE150		ET-DLE250	
Throw ratio*1			1.8-2.5:1		0.8:1	0.8-1.0:1		1.3-2.0:1		2.4-3.7:1	
Projection screen size			Projection distance (L)								
Diagonal (SD)	Height (SH)	Width (SW)	Min. (LW)	Max. (LT)	Fixed	Min. (LW)	Max. (LT)	Min. (LW)	Max. (LT)	Min. (LW)	Max. (LT)
1.27 (50")	0.762	1.016	1.78	2.51	0.81	0.81	1.01	1.34	1.97	2.36	3.78
1.52 (60")	0.914	1.219	2.15	3.03	0.98	0.98	1.22	1.62	2.37	2.85	4.55
1.78 (70")	1.067	1.422	2.52	3.55	1.15	1.15	1.43	1.90	2.77	3.34	5.32
2.03 (80")	1.219	1.626	2.89	4.06	1.32	1.32	1.64	2.18	3.18	3.83	6.09
2.29 (90")	1.372	1.829	3.26	4.58	1.49	1.49	1.85	2.46	3.58	4.31	6.86
2.54 (100")	1.524	2.032	3.63	5.10	1.66	1.66	2.07	2.74	3.98	4.80	7.63
3.05 (120")	1.829	2.438	4.37	6.13	2.01	2.00	2.49	3.30	4.79	5.78	9.17
3.81 (150")	2.286	3.048	5.48	7.68	2.52	2.51	3.12	4.14	6.00	7.24	11.49
5.08 (200")	3.048	4.064	7.33	10.26	3.38	3.36	4.18	5.54	8.02	9.69	15.34
6.35 (250")	3.810	5.080	9.18	12.85	—	4.21	5.23	6.94	10.03	12.13	19.20
7.62 (300")	4.572	6.096	11.03	15.43	—	5.07	6.29	8.33	12.05	14.57	23.06
8.89 (350")	5.334	7.112	12.88	18.02	—	5.92	7.34	9.73	14.07	17.01	26.91
10.16 (400")	6.096	8.128	14.73	20.60	—	6.77	8.40	11.13	16.08	19.45	30.77
12.70 (500")	7.620	10.160	18.43	25.77	—	8.48	10.51	13.92	20.12	24.33	38.48
15.24 (600")	9.144	12.192	22.13	30.94	—	10.18	12.62	16.72	24.15	29.22	46.19

Lens type			Optional lens				Height position (H)*2		
			Long focus zoom lens		Ultra long focus zoom lens				
Projection lens Model No.			ET-DLE350		ET-DLE450		Standard zoom lens/ ET-DLE150/ ET-DLE250/ ET-DLE350/ ET-DLE450	ET-DLE085	ET-DLE055 (Fixed)
Throw ratio*1			3.7-5.6:1		5.5-8.9:1				
Projection screen size			Projection distance (L)						
Diagonal (SD)	Height (SH)	Width (SW)	Min. (LW)	Max. (LT)	Min. (LW)	Max. (LT)			
1.27 (50")	0.762	1.016	3.71	5.68	5.52	8.91	0 - 0.38	0.04 - 0.38	0.38
1.52 (60")	0.914	1.219	4.48	6.84	6.69	10.75	0 - 0.46	0.05 - 0.46	0.46
1.78 (70")	1.067	1.422	5.25	8.01	7.86	12.60	0 - 0.53	0.05 - 0.53	0.53
2.03 (80")	1.219	1.626	6.02	9.17	9.02	14.44	0 - 0.61	0.06 - 0.61	0.61
2.29 (90")	1.372	1.829	6.79	10.33	10.19	16.28	0 - 0.69	0.07 - 0.69	0.69
2.54 (100")	1.524	2.032	7.56	11.50	11.35	18.12	0 - 0.76	0.08 - 0.76	0.76
3.05 (120")	1.829	2.438	9.10	13.82	13.68	21.81	0 - 0.91	0.09 - 0.91	0.91
3.81 (150")	2.286	3.048	11.41	17.31	17.18	27.33	0 - 1.14	0.11 - 1.14	1.14
5.08 (200")	3.048	4.064	15.26	23.13	23.00	36.54	0 - 1.52	0.15 - 1.52	1.52
6.35 (250")	3.810	5.080	19.11	28.94	28.83	45.75	0 - 1.91	0.19 - 1.91	—
7.62 (300")	4.572	6.096	22.96	34.76	34.66	54.97	0 - 2.29	0.23 - 2.29	—
8.89 (350")	5.334	7.112	26.80	40.57	40.48	64.18	0 - 2.67	0.27 - 2.67	—
10.16 (400")	6.096	8.128	30.65	46.39	46.31	73.39	0 - 3.05	0.30 - 3.05	—
12.70 (500")	7.620	10.160	38.35	58.02	57.96	91.81	0 - 3.81	0.38 - 3.81	—
15.24 (600")	9.144	12.192	46.05	69.65	69.61	110.23	0 - 4.57	0.46 - 4.57	—

\*1 The throw ratio is based on the value during projection onto a 2.03 m (80") screen size.

\*2 When the fixed-focus lens (Model No.: ET-DLE055) is attached, the lens shift is not possible. The height position (H) becomes SH/2.

■ When the screen aspect is 16:9

(Unit: m)

Lens type			Standard zoom lens		Optional lens						
					Fixed-focus lens	Ultra short focus zoom lens		Short focus zoom lens		Intermediate focus zoom lens	
Projection lens Model No.			—		ET-DLE055	ET-DLE085		ET-DLE150		ET-DLE250	
Throw ratio*1			1.8-2.5:1		0.8:1	0.8-1.0:1		1.3-2.0:1		2.4-3.8:1	
Projection screen size			Projection distance (L)								
Diagonal (SD)	Height (SH)	Width (SW)	Min. (LW)	Max. (LT)	Fixed	Min. (LW)	Max. (LT)	Min. (LW)	Max. (LT)	Min. (LW)	Max. (LT)
1.27 (50")	0.623	1.107	1.94	2.74	0.88	0.88	1.11	1.47	2.15	2.58	4.12
1.52 (60")	0.747	1.328	2.34	3.31	1.07	1.07	1.34	1.77	2.59	3.11	4.96
1.78 (70")	0.872	1.550	2.75	3.87	1.26	1.25	1.57	2.08	3.03	3.64	5.80
2.03 (80")	0.996	1.771	3.15	4.43	1.44	1.44	1.79	2.38	3.47	4.18	6.64
2.29 (90")	1.121	1.992	3.55	4.99	1.63	1.62	2.02	2.69	3.90	4.71	7.48
2.54 (100")	1.245	2.214	3.96	5.56	1.82	1.81	2.25	2.99	4.34	5.24	8.32
3.05 (120")	1.494	2.657	4.76	6.68	2.19	2.18	2.71	3.60	5.22	6.30	10.00
3.81 (150")	1.868	3.321	5.97	8.37	2.75	2.74	3.40	4.51	6.54	7.90	12.52
5.08 (200")	2.491	4.428	7.99	11.19	3.68	3.67	4.55	6.04	8.74	10.56	16.72
6.35 (250")	3.113	5.535	10.01	14.00	—	4.60	5.70	7.56	10.93	13.22	20.93
7.62 (300")	3.736	6.641	12.02	16.82	—	5.52	6.85	9.08	13.13	15.88	25.13
8.89 (350")	4.358	7.748	14.04	19.63	—	6.45	8.00	10.61	15.33	18.54	29.33
10.16 (400")	4.981	8.855	16.05	22.45	—	7.38	9.15	12.13	17.53	21.20	33.53
12.70 (500")	6.226	11.069	20.09	28.08	—	9.24	11.45	15.17	21.92	26.52	41.93
15.24 (600")	7.472	13.283	24.12	33.71	—	11.10	13.75	18.22	26.31	31.84	50.33

Lens type			Optional lens				Height position (H) <sup>2</sup>		
			Long focus zoom lens		Ultra long focus zoom lens				
Projection lens Model No.			ET-DLE350		ET-DLE450		Standard zoom lens/ ET-DLE150/ ET-DLE250/ ET-DLE350/ ET-DLE450	ET-DLE085	ET-DLE055 (Fixed)
Throw ratio*1			3.7-5.6:1		5.6-8.9:1				
Projection screen size			Projection distance (L)				ET-DLE085	ET-DLE055 (Fixed)	
Diagonal (SD)	Height (SH)	Width (SW)	Min. (LW)	Max. (LT)	Min. (LW)	Max. (LT)			
1.27 (50")	0.623	1.107	4.06	6.20	6.05	9.74	-0.21 - 0.31	-0.16 - 0.31	0.31
1.52 (60")	0.747	1.328	4.90	7.47	7.32	11.74	-0.25 - 0.37	-0.19 - 0.37	0.37
1.78 (70")	0.872	1.550	5.73	8.74	8.58	13.75	-0.29 - 0.44	-0.23 - 0.44	0.44
2.03 (80")	0.996	1.771	6.57	10.00	9.85	15.76	-0.33 - 0.50	-0.26 - 0.50	0.50
2.29 (90")	1.121	1.992	7.41	11.27	11.12	17.76	-0.37 - 0.56	-0.29 - 0.56	0.56
2.54 (100")	1.245	2.214	8.25	12.54	12.39	19.77	-0.41 - 0.62	-0.32 - 0.62	0.62
3.05 (120")	1.494	2.657	9.93	15.07	14.93	23.78	-0.49 - 0.75	-0.39 - 0.75	0.75
3.81 (150")	1.868	3.321	12.44	18.87	18.74	29.81	-0.62 - 0.93	-0.49 - 0.93	0.93
5.08 (200")	2.491	4.428	16.64	25.21	25.09	39.84	-0.82 - 1.25	-0.65 - 1.25	1.25
6.35 (250")	3.113	5.535	20.83	31.54	31.44	49.88	-1.03 - 1.56	-0.81 - 1.56	—
7.62 (300")	3.736	6.641	25.02	37.88	37.78	59.91	-1.23 - 1.87	-0.97 - 1.87	—
8.89 (350")	4.358	7.748	29.22	44.22	44.13	69.95	-1.44 - 2.18	-1.13 - 2.18	—
10.16 (400")	4.981	8.855	33.41	50.55	50.48	79.98	-1.64 - 2.49	-1.30 - 2.49	—
12.70 (500")	6.226	11.069	41.79	63.22	63.17	100.05	-2.05 - 3.11	-1.62 - 3.11	—
15.24 (600")	7.472	13.283	50.18	75.89	75.87	120.12	-2.47 - 3.74	-1.94 - 3.74	—

\*1 The throw ratio is based on the value during projection onto a 2.03 m (80") screen size.

\*2 When the fixed-focus lens (Model No.: ET-DLE055) is attached, the lens shift is not possible. The height position (H) becomes SH/2.



**Formula to calculate projection distance per projection lens**

To use a screen size not listed in this manual, check the screen size SD (m) and use the respective formula to calculate projection distance. The unit of all the formulae is m. (Values obtained by the following calculation formulae contain a slight error.)

**For PT-DZ870E**

Lens type	Projection lens Model No.	Aspect ratio	Projection distance (L) formula	
Standard zoom lens	—	16:10	Min. (LW)	$L = 1.4906 \times SD - 0.0746$
			Max. (LT)	$L = 2.0814 \times SD - 0.0725$
		16:9	Min. (LW)	$L = 1.5320 \times SD - 0.0746$
			Max. (LT)	$L = 2.1393 \times SD - 0.0725$
		4:3	Min. (LW)	$L = 1.6874 \times SD - 0.0746$
			Max. (LT)	$L = 2.3563 \times SD - 0.0725$
Fixed-focus lens	ET-DLE055	16:10	—	$L = 0.6893 \times SD - 0.0476$
		16:9	—	$L = 0.7084 \times SD - 0.0476$
		4:3	—	$L = 0.7803 \times SD - 0.0476$
Ultra short focus zoom lens	ET-DLE085	16:10	Min. (LW)	$L = 0.6865 \times SD - 0.0471$
			Max. (LT)	$L = 0.8498 \times SD - 0.0442$
		16:9	Min. (LW)	$L = 0.7056 \times SD - 0.0471$
			Max. (LT)	$L = 0.8735 \times SD - 0.0442$
		4:3	Min. (LW)	$L = 0.7772 \times SD - 0.0471$
			Max. (LT)	$L = 0.9621 \times SD - 0.0442$
Short focus zoom lens	ET-DLE150	16:10	Min. (LW)	$L = 1.1259 \times SD - 0.0540$
			Max. (LT)	$L = 1.6243 \times SD - 0.0498$
		16:9	Min. (LW)	$L = 1.1572 \times SD - 0.0540$
			Max. (LT)	$L = 1.6695 \times SD - 0.0498$
		4:3	Min. (LW)	$L = 1.2747 \times SD - 0.0540$
			Max. (LT)	$L = 1.8388 \times SD - 0.0498$
Intermediate focus zoom lens	ET-DLE250	16:10	Min. (LW)	$L = 1.9665 \times SD - 0.0800$
			Max. (LT)	$L = 3.1059 \times SD - 0.0792$
		16:9	Min. (LW)	$L = 2.0212 \times SD - 0.0800$
			Max. (LT)	$L = 3.1923 \times SD - 0.0792$
		4:3	Min. (LW)	$L = 2.2263 \times SD - 0.0800$
			Max. (LT)	$L = 3.5161 \times SD - 0.0792$
Long focus zoom lens	ET-DLE350	16:10	Min. (LW)	$L = 3.1000 \times SD - 0.1351$
			Max. (LT)	$L = 4.6843 \times SD - 0.1346$
		16:9	Min. (LW)	$L = 3.1862 \times SD - 0.1351$
			Max. (LT)	$L = 4.8146 \times SD - 0.1346$
		4:3	Min. (LW)	$L = 3.5094 \times SD - 0.1351$
			Max. (LT)	$L = 5.3030 \times SD - 0.1346$
Ultra long focus zoom lens	ET-DLE450	16:10	Min. (LW)	$L = 4.6931 \times SD - 0.3017$
			Max. (LT)	$L = 7.4193 \times SD - 0.2991$
		16:9	Min. (LW)	$L = 4.8236 \times SD - 0.3017$
			Max. (LT)	$L = 7.6256 \times SD - 0.2991$
		4:3	Min. (LW)	$L = 5.3129 \times SD - 0.3017$
			Max. (LT)	$L = 8.3992 \times SD - 0.2991$



For PT-DW830E

Lens type	Projection lens Model No.	Aspect ratio	Projection distance (L) formula	
Standard zoom lens	—	16:10	Min. (LW)	$L = 1.5651 \times SD - 0.0746$
			Max. (LT)	$L = 2.1855 \times SD - 0.0725$
		16:9	Min. (LW)	$L = 1.6086 \times SD - 0.0746$
			Max. (LT)	$L = 2.2462 \times SD - 0.0725$
		4:3	Min. (LW)	$L = 1.7715 \times SD - 0.0746$
			Max. (LT)	$L = 2.4736 \times SD - 0.0725$
Fixed-focus lens	ET-DLE055	16:10	—	$L = 0.7237 \times SD - 0.0476$
		16:9	—	$L = 0.7438 \times SD - 0.0476$
		4:3	—	$L = 0.8191 \times SD - 0.0476$
Ultra short focus zoom lens	ET-DLE085	16:10	Min. (LW)	$L = 0.7209 \times SD - 0.0471$
			Max. (LT)	$L = 0.8923 \times SD - 0.0442$
		16:9	Min. (LW)	$L = 0.7409 \times SD - 0.0471$
			Max. (LT)	$L = 0.9171 \times SD - 0.0442$
		4:3	Min. (LW)	$L = 0.8159 \times SD - 0.0471$
			Max. (LT)	$L = 1.0100 \times SD - 0.0442$
Short focus zoom lens	ET-DLE150	16:10	Min. (LW)	$L = 1.1822 \times SD - 0.0540$
			Max. (LT)	$L = 1.7055 \times SD - 0.0498$
		16:9	Min. (LW)	$L = 1.2151 \times SD - 0.0540$
			Max. (LT)	$L = 1.7529 \times SD - 0.0498$
		4:3	Min. (LW)	$L = 1.3381 \times SD - 0.0540$
			Max. (LT)	$L = 1.9304 \times SD - 0.0498$
Intermediate focus zoom lens	ET-DLE250	16:10	Min. (LW)	$L = 2.0649 \times SD - 0.0800$
			Max. (LT)	$L = 3.2612 \times SD - 0.0792$
		16:9	Min. (LW)	$L = 2.1223 \times SD - 0.0800$
			Max. (LT)	$L = 3.3519 \times SD - 0.0792$
		4:3	Min. (LW)	$L = 2.3371 \times SD - 0.0800$
			Max. (LT)	$L = 3.6912 \times SD - 0.0792$
Long focus zoom lens	ET-DLE350	16:10	Min. (LW)	$L = 3.2550 \times SD - 0.1351$
			Max. (LT)	$L = 4.9185 \times SD - 0.1346$
		16:9	Min. (LW)	$L = 3.3455 \times SD - 0.1351$
			Max. (LT)	$L = 5.0553 \times SD - 0.1346$
		4:3	Min. (LW)	$L = 3.6842 \times SD - 0.1351$
			Max. (LT)	$L = 5.5671 \times SD - 0.1346$
Ultra long focus zoom lens	ET-DLE450	16:10	Min. (LW)	$L = 4.9277 \times SD - 0.3017$
			Max. (LT)	$L = 7.7903 \times SD - 0.2991$
		16:9	Min. (LW)	$L = 5.0647 \times SD - 0.3017$
			Max. (LT)	$L = 8.0069 \times SD - 0.2991$
		4:3	Min. (LW)	$L = 5.5775 \times SD - 0.3017$
			Max. (LT)	$L = 8.8174 \times SD - 0.2991$

For PT-DX100E

Lens type	Projection lens Model No.	Aspect ratio	Projection distance (L) formula	
			Min. (LW)	Max. (LT)
Standard zoom lens	—	4:3	Min. (LW)	$L = 1.4571 \times SD - 0.0746$
			Max. (LT)	$L = 2.0346 \times SD - 0.0725$
		16:9	Min. (LW)	$L = 1.5875 \times SD - 0.0746$
			Max. (LT)	$L = 2.2167 \times SD - 0.0725$
Fixed-focus lens	ET-DLE055	4:3	—	$L = 0.6738 \times SD - 0.0476$
		16:9	—	$L = 0.7340 \times SD - 0.0476$
Ultra short focus zoom lens	ET-DLE085	4:3	Min. (LW)	$L = 0.6711 \times SD - 0.0471$
			Max. (LT)	$L = 0.8307 \times SD - 0.0442$
		16:9	Min. (LW)	$L = 0.7311 \times SD - 0.0471$
			Max. (LT)	$L = 0.9051 \times SD - 0.0442$
Short focus zoom lens	ET-DLE150	4:3	Min. (LW)	$L = 1.1006 \times SD - 0.0540$
			Max. (LT)	$L = 1.5878 \times SD - 0.0498$
		16:9	Min. (LW)	$L = 1.1991 \times SD - 0.0540$
			Max. (LT)	$L = 1.7299 \times SD - 0.0498$
Intermediate focus zoom lens	ET-DLE250	4:3	Min. (LW)	$L = 1.9224 \times SD - 0.0800$
			Max. (LT)	$L = 3.0361 \times SD - 0.0792$
		16:9	Min. (LW)	$L = 2.0943 \times SD - 0.0800$
			Max. (LT)	$L = 3.3078 \times SD - 0.0792$
Long focus zoom lens	ET-DLE350	4:3	Min. (LW)	$L = 3.0304 \times SD - 0.1351$
			Max. (LT)	$L = 4.5791 \times SD - 0.1346$
		16:9	Min. (LW)	$L = 3.3015 \times SD - 0.1351$
			Max. (LT)	$L = 4.9888 \times SD - 0.1346$
Ultra long focus zoom lens	ET-DLE450	4:3	Min. (LW)	$L = 4.5876 \times SD - 0.3017$
			Max. (LT)	$L = 7.2526 \times SD - 0.2991$
		16:9	Min. (LW)	$L = 4.9981 \times SD - 0.3017$
			Max. (LT)	$L = 7.9015 \times SD - 0.2991$

### Adjusting adjustable feet

Install the projector on a flat surface so that the front of the projector is parallel to the screen surface and the projection screen is rectangular. If the screen is tilted downward, the projection screen can be adjusted to be rectangular by adjusting the front adjustable feet. The adjustable feet can also be used to adjust the projector to be level when it is tilted in the horizontal direction.

Extend the adjustable feet by rotating in the direction shown in the figure and retract by rotating in the opposite direction.

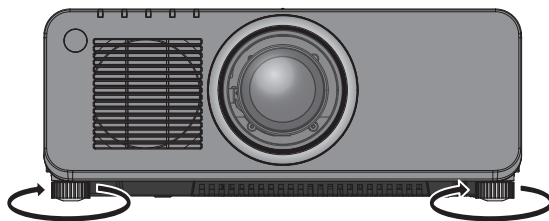

**Adjustable amount**

Each adjustable feet: Approx. 30 mm (1-3/16")

### Attention

- Heated air is expelled from the air exhaust port while the lamp is lit. Do not touch the air exhaust port directly when adjusting the adjustable feet. (➔ page 26)

## Removing/attaching the projection lens

Attaching and removing method of the projection lens are same for both standard zoom lenses and optional accessories.  
Move the projection lens to the home position before replacing or removing the projection lens. (➔ page 59)

### Attention

- Replace the projection lens after turning off the power of the projector.
- Do not touch the lens signal receiver. Dust or dirt may cause defective contact.
- Do not touch the surface of the projection lens with your bare hands.
- Before attaching the projection lens, remove the lens cover attached to the projection lens.
- In case of the ultra short focus zoom lens (Model No.: ET-DLE085), attachment/removal procedures of the Lens Mount Cover are different. Refer to the user manual supplied with ET-DLE085 for details.

### Removing the projection lens

Remove the projection lens using the following procedure.

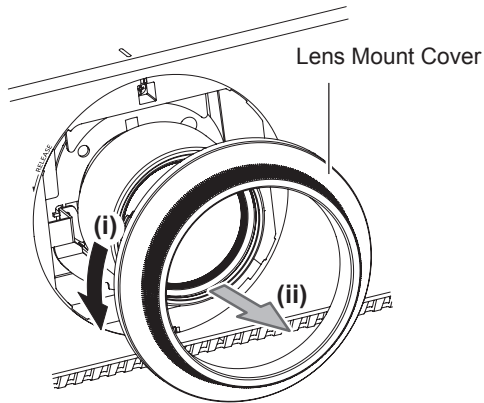

Fig. 1

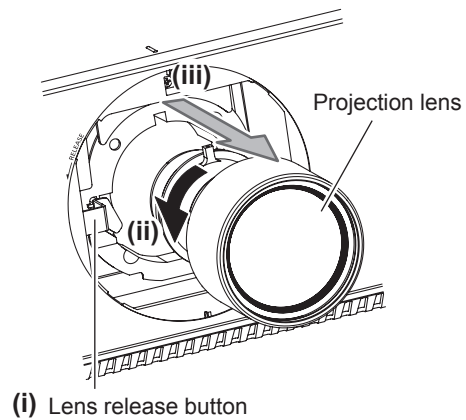

Fig. 2

- 1) Turn the Lens Mount Cover counterclockwise and remove. (Fig. 1)
- 2) While keep pressing the lens release button, turn the projection lens counterclockwise to the end and remove. (Fig. 2)

### Attention

- Store the removed projection lens where it will be free from vibration and impact.

## Attaching the projection lens

Attach the projection lens using the following procedure.

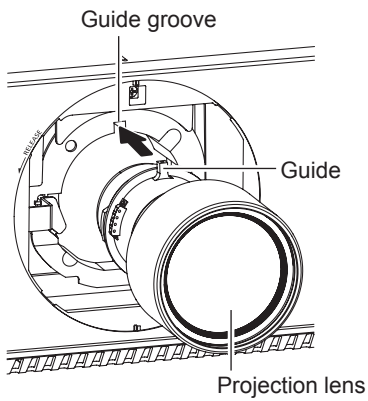

Fig. 1

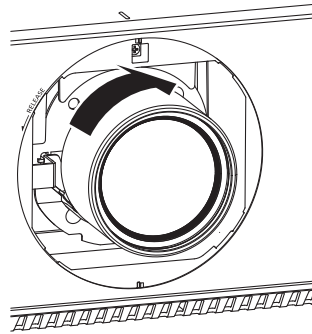

Fig. 2

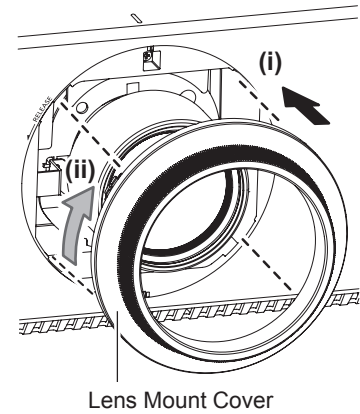

Fig. 3

- 1) **Remove the Lens Mount Cover, and align the projection lens guide to the guide groove of the projector and insert to the end. (Fig. 1)**
- 2) **Turn the projection lens clockwise until it clicks. (Fig. 2)**
- 3) **Attach the Lens Mount Cover. (Fig. 3)**
  - Align the Lens Mount Cover and the projector at dotted line positions in the figure to attach, and turn the Lens Mount Cover clockwise and fix to the projector.

### Attention

- Turn the projection lens counterclockwise to confirm that it does not come out.

# Connecting

## Before connecting

- Before connecting, carefully read the operating instructions for the external device to be connected.
- Turn off the power of all devices before connecting cables.
- Take note of the following points before connecting the cables. Failure to do so may result in malfunctions.
  - When connecting a cable to a device connected to the projector or the projector itself, touch any nearby metallic objects to eliminate static electricity from your body before performing work.
  - Do not use unnecessarily long cables to connect to a device connected to the projector or to the projector body. The longer the cable, the more it is susceptible to noise. Since using a cable while it is wound makes it act like an antenna, it is more susceptible to noise.
  - When connecting cables, connect GND first, then insert the connecting terminal of the connecting device in a straight manner.
- Acquire any connection cable necessary to connect the external device to the system that is neither supplied with the device nor available as an option.
- If video signals from video equipment contain too much jitter, the images on the screen may wobble. In this case, a time base corrector (TBC) must be connected.
- The projector accepts video signals (including Y/C signals), analog RGB signals (synchronous signals are TTL level), and digital signals.
- Some computer models are not compatible with the projector.
- Use a cable compensator when you connect devices to the projector using long cables. Otherwise the image may not display properly.
- Refer to “List of compatible signals” (➔ page 178) for the types of video signals that can be used with the projector.

## <RGB 2 IN> terminal pin assignments and signal names

Outside view	Pin No.	Signal name	Pin No.	Signal name
	(1)	R/P <sub>R</sub>	(9)	—
	(2)	G/Y	(10)	GND
	(3)	B/P <sub>B</sub>	(11)	GND
	(4)	—	(12)	DDC data
	(5)	GND	(13)	SYNC/HD
	(6)	GND	(14)	VD
	(7)	GND	(15)	DDC clock
	(8)	GND		

## <HDMI IN> terminal pin assignments and signal names

Outside view	Pin No.	Signal name	Pin No.	Signal name
<p>Even-numbered pins of (2) to (18)</p> <p>Odd-numbered pins of (1) to (19)</p>	(1)	T.M.D.S data 2+	(11)	T.M.D.S clock shield
	(2)	T.M.D.S data 2 shield	(12)	T.M.D.S clock-
	(3)	T.M.D.S data 2-	(13)	CEC
	(4)	T.M.D.S data 1+	(14)	—
	(5)	T.M.D.S data 1 shield	(15)	SCL
	(6)	T.M.D.S data 1-	(16)	SDA
	(7)	T.M.D.S data 0+	(17)	DDC/CEC GND
	(8)	T.M.D.S data 0 shield	(18)	+5 V
	(9)	T.M.D.S data 0-	(19)	Hot plug detection
	(10)	T.M.D.S clock+		

<DVI-D IN> terminal pin assignments and signal names

Outside view	Pin No.	Signal name	Pin No.	Signal name
	(1)	T.M.D.S data 2-	(13)	—
	(2)	T.M.D.S data 2+	(14)	+5 V
	(3)	T.M.D.S data 2/4 shield	(15)	GND
	(4)	—	(16)	Hot plug detection
	(5)	—	(17)	T.M.D.S data 0-
	(6)	DDC clock	(18)	T.M.D.S data 0+
	(7)	DDC data	(19)	T.M.D.S data 0/5 shield
	(8)	—	(20)	—
	(9)	T.M.D.S data 1-	(21)	—
	(10)	T.M.D.S clock1+	(22)	T.M.D.S clock shield
	(11)	T.M.D.S data 1/3 shield	(23)	T.M.D.S clock+
	(12)	—	(24)	T.M.D.S clock-

Connecting example: AV equipment

For <HDMI IN>/<DVI-D IN>/<VIDEO IN> terminals

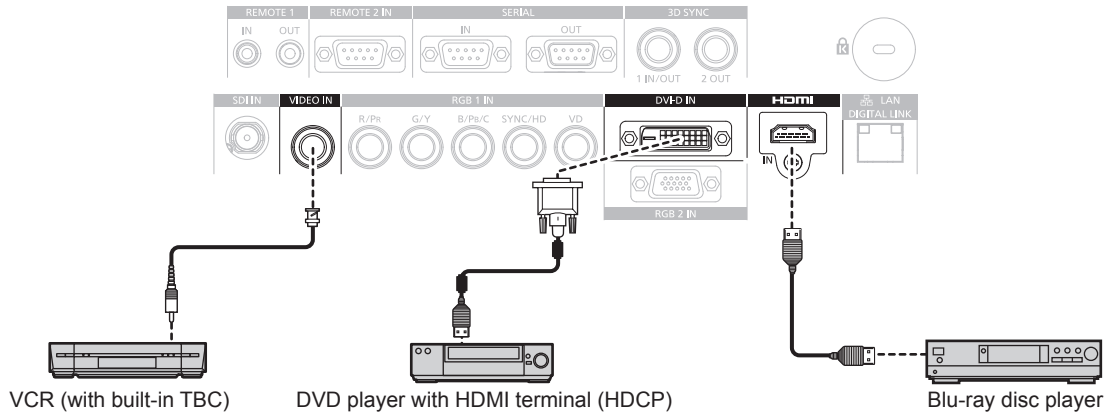

Attention

- Always use one of the following when connecting a VCR.
  - A VCR with built-in time base corrector (TBC)
  - A time base corrector (TBC) between the projector and the VCR
- If nonstandard burst signals are connected, the image may be distorted. In such case, connect the time base corrector (TBC) between the projector and the external devices.

Note

- When entering DVI-D, some external devices to be connected may require switching the setting using the [DISPLAY OPTION] menu → [DVI-D IN] → [EDID].
- The <DVI-D IN> terminal can be connected to HDMI- or DVI-D-compliant devices. However, images may not appear or may not be displayed properly on some devices.
- For an HDMI cable, use an HDMI High Speed cable that conforms to HDMI standards. If a cable that does not conform to HDMI standards is used, images may be interrupted or may not be displayed.
- The <HDMI IN> terminal of the projector can be connected to an external device with a DVI-D terminal by using an HDMI/DVI conversion cable, but some devices may not project the image properly or function properly.
- The projector does not support VIERA Link (HDMI).

**For <SDI IN> terminal**

(Only for PT-DZ870E)

Digital VCR for commercial use

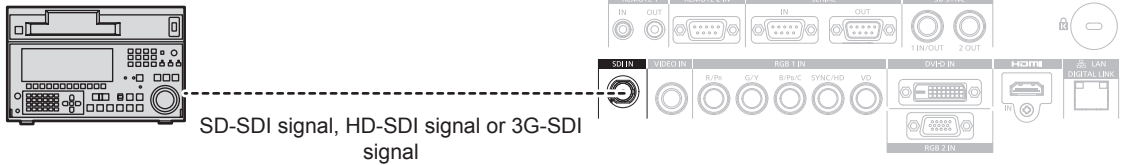

**Note**

- Use the [PICTURE] menu → [SYSTEM SELECTOR] to switch the input format.
- Some external devices to be connected require the [DISPLAY OPTION] menu → [SDI IN] to be set.
- Use a 5CFB or higher (such as 5CFB, or 7CFB) or a Belden 1694A or higher connection cable to properly transmit images. Use a connection cable of 100 m (328'1") length or less.
- When an unsteady signal is connected, an error in signal detection may occur. In such a case, use the [PICTURE] menu → [SYSTEM SELECTOR] to switch to a system that matches the signal format.

**Connecting example: Computers**

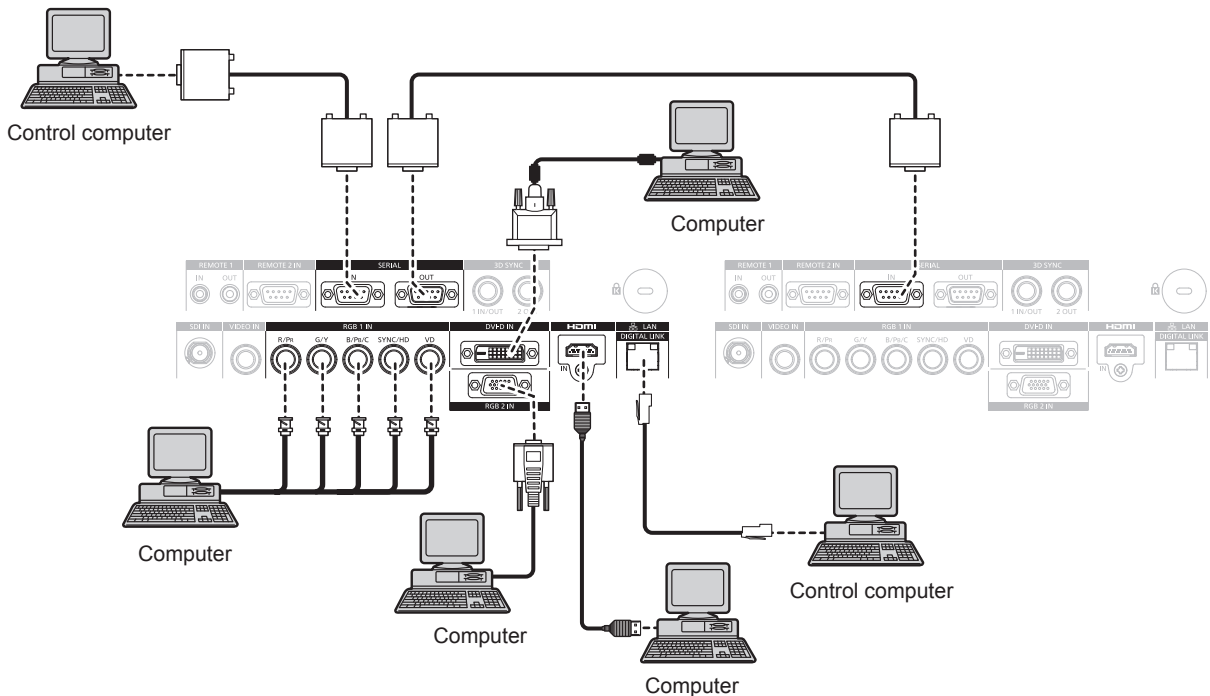

**Attention**

- When connecting the projector to a computer or an external device, use the power cord supplied with each device and commercially available shielded cables.
- Use a commercial cable with a ferrite core for connecting with the <DVI-D IN> terminal.

**Note**

- When entering DVI-D, some external devices to be connected may require switching the setting using the [DISPLAY OPTION] menu → [DVI-D IN] → [EDID].
- For an HDMI cable, use an HDMI High Speed cable that conforms to HDMI standards. If a cable that does not conform to HDMI standards is used, images may be interrupted or may not be displayed.
- The <HDMI IN> terminal of the projector can be connected to an external device with a DVI-D terminal by using an HDMI/DVI conversion cable, but some devices may not project the image properly or function properly.
- The <DVI-D IN> terminal supports single links only.
- When entering the SYNC ON GREEN signal, do not enter sync signals to the <SYNC/HD> terminal or the <VD> terminal.
- If you operate the projector using the computer with the resume feature (last memory), you may have to reset the resume feature to operate the projector.

## Connecting example: Twisted-pair-cable transmitter

Twisted-pair-cable transmitters such as the optional Digital Interface Box (Model No.: ET-YFB100G) use twisted-pair-cables to transmit input images, Ethernet, and serial control signals, and the projector can input those digital signals to the <DIGITAL LINK/LAN> terminal.

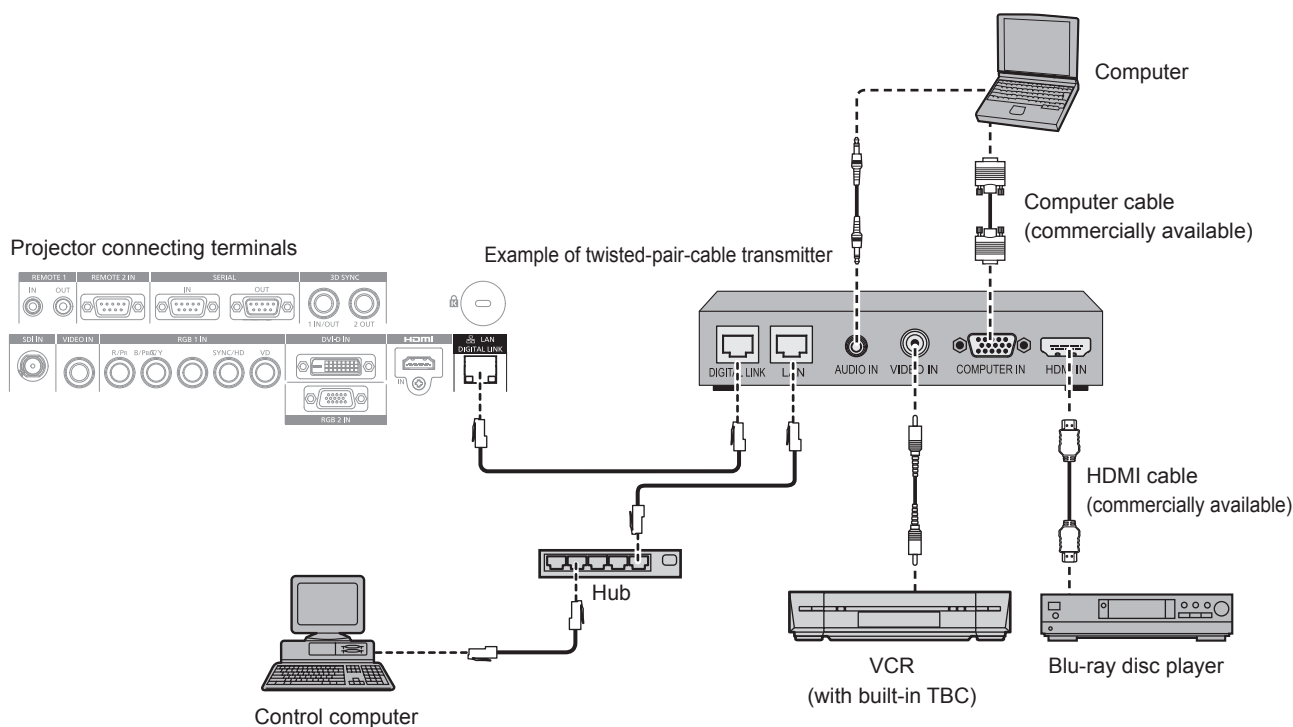

### Attention

- Always use one of the following when connecting a VCR.
  - A VCR with built-in time base corrector (TBC)
  - A time base corrector (TBC) between the projector and the VCR
- If nonstandard burst signals are connected, the image may be distorted. In such case, connect the time base corrector (TBC) between the projector and the external devices.
- Use a commercial HDMI/DVI conversion cable with a ferrite core.
- Ask a qualified technician or your dealer to install the cable wiring for a twisted-pair-cable transmitter and the projector. Image may be disrupted if cable transmission characteristics cannot be obtained due to inadequate installation.
- For the LAN cable between a twisted-pair-cable transmitter and the projector, use a cable that meets the following criteria:
  - Compatible with CAT5e or higher
  - Shielded type (including connectors)
  - Straight-through
  - Single wire
- When laying cables between a twisted-pair-cable transmitter and the projector, check that cable characteristics are compatible with CAT5e or higher using tools such as a cable tester or cable analyzer. When using a relay connector midway, include it in the measurement.
- Do not use a hub between a twisted-pair-cable transmitter and the projector.
- When connecting to the projector using a twisted-pair-cable transmitter (receiver) of other manufacturer, do not place another twisted-pair-cable transmitter (receiver) between the twisted-pair-cable transmitter of other manufacturer and the projector. This may cause image to be disrupted.
- Do not pull cables forcefully. Also, do not bend or fold cables unnecessarily.
- To reduce the effects of noise as much as possible, stretch out the cables between the twisted-pair-cable transmitter and the projector without any loops.
- Lay the cables between a twisted-pair-cable transmitter and the projector away from other cables, particularly power cables.
- When installing multiple cables, run them side by side along the shortest distance possible without bundling them together.
- After laying the cables, confirm that the value of [SIGNAL QUALITY] in the [NETWORK] menu → [DIGITAL LINK STATUS] is displayed in green (indicates normal quality). (➔ page 135)

### Note

- For an HDMI cable, use an HDMI High Speed cable that conforms to HDMI standards. If a cable that does not conform to HDMI standards is used, image may be interrupted or may not be displayed.
- The projector does not support VIERA Link (HDMI).
- The maximum transmission distance between the twisted-pair-cable transmitter and the projector is 100 m (328'1"). If this distance is exceeded, image may be disrupted and may cause a malfunction in LAN communication. Please note that we do not support the use of the projector outside the maximum transmission distance.
- For twisted-pair-cable transmitter of other manufacturers of which the operation has been verified with the DIGITAL LINK compatible projector, refer to Panasonic website (<http://panasonic.net/avc/projector/>). Note that the verification for devices of other manufacturers has been made for the items set by Panasonic Corporation, and not all the operations have been verified. For operation or performance problems caused by the devices of other manufacturers, contact the respective manufacturers.



# Chapter 3 Basic Operations

---

This chapter describes basic operations to start with.

# Switching on/off the projector

## Connecting the power cord

Make sure that the supplied power cord is securely fixed to the projector body to prevent it from being removed easily.

Confirm that the <MAIN POWER> switch is on the <OFF> side before connecting the power cord.

For details of power cord handling, refer to “Read this first!” (➔ page 2).

## Attaching the power cord

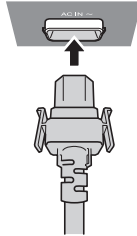

- 1) Check the shapes of the <AC IN> terminal on the side of the projector body and the power cord connector and insert the plug completely in the correct direction (until you hear the side tabs click in place).

## Removing the power cord

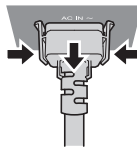

- 1) Confirm that the <MAIN POWER> switch on the side of the projector body is on the <OFF> side, and remove the power plug from the outlet.
- 2) Remove the power cord connector from the <AC IN> terminal of the projector body while pressing the side tabs.

## Power indicator

Displays the status of the power. Check the <ON (G)/STANDBY (R)> status of the power indicator before operating the projector.

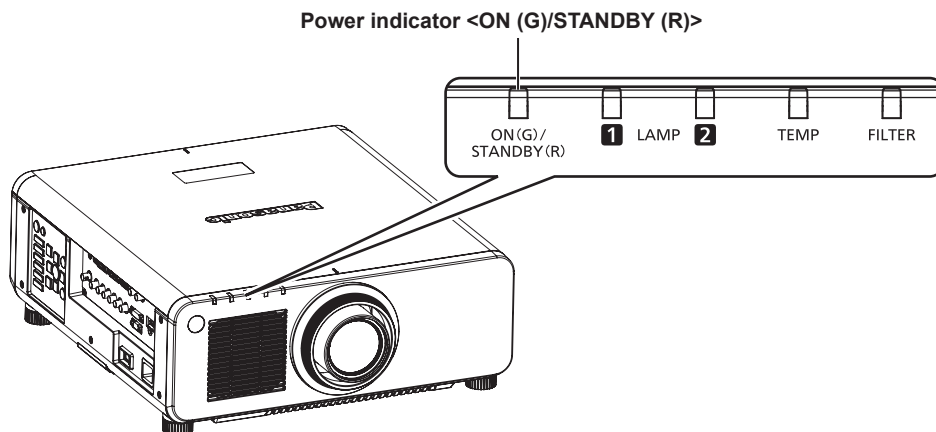

Indicator status		Projector status
Off		The main power is switched off.
Red	Lit	The power is switched off (in standby mode). Projection will start when the power on < > button is pressed. • The projector may not operate when the lamp indicators <LAMP1>/<LAMP2> or temperature indicator <TEMP> are flashing. (➔ page 157)
Green	Lit	Projecting.
Orange	Lit	The projector is preparing to switch off the projector. The power is switched off after a while. (Changes to the standby mode.)

### Note

- While the power indicator <ON (G)/STANDBY (R)> is lit in orange, the fan is running to cool the projector.
- For about 75 seconds after the projector is switched off and the luminous lamp cooling is started, the lamp indicators do not light up even if the power is switched on. After the power indicator <ON (G)/STANDBY (R)> lights in red, turn on the power again.
- The projector consumes power even in standby mode (power indicator <ON (G)/STANDBY (R)> lit in red). Refer to “Power consumption” (➔ page 183) for the power consumption.
- The power indicator <ON (G)/STANDBY (R)> will flash if the projector receives a remote control signal.
- The power indicator <ON (G)/STANDBY (R)> will flash slowly in green while the shutter is closed.
- If the power indicator <ON (G)/STANDBY (R)> is flashing in red, consult your dealer.

### Switching on the projector

When using the optional projection lens, attach the projection lens before switching on the projector.  
Remove the lens cover first.

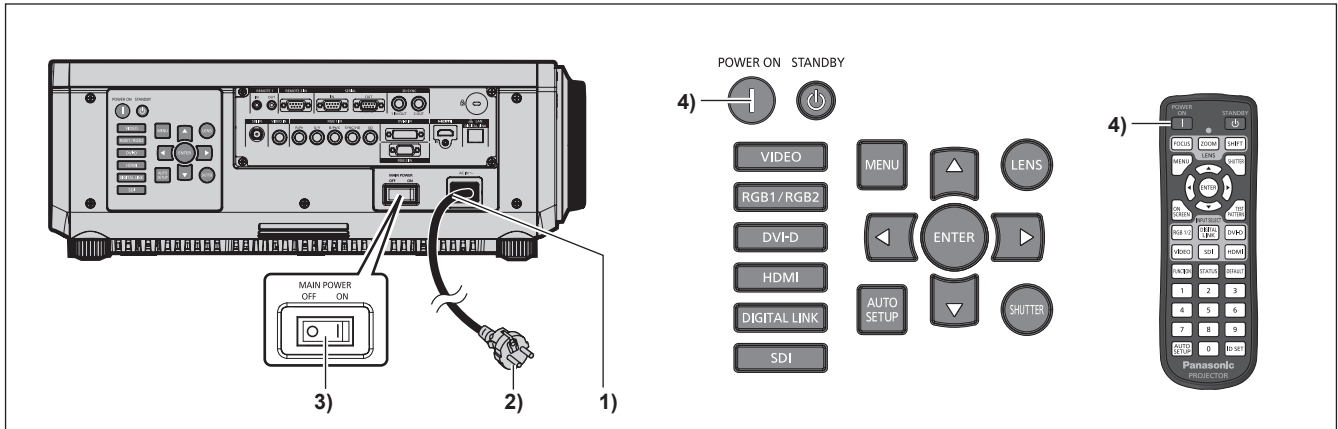

- 1) Connect the power cord to the projector body.**
- 2) Connect the power plug to an outlet.**
  - (AC 120 V - 240 V 50 Hz/60 Hz)
- 3) Press the <ON> side of the <MAIN POWER> switch to turn on the power.**
  - The power indicator <ON (G)/STANDBY (R)> will light in red, and the projector will enter the standby mode.
- 4) Press the power on <|> button.**
  - The power indicator <ON (G)/STANDBY (R)> lights in green and the image is soon projected on the screen.

### Note

- If the projector is switched on at around 0 °C (32 °F), a warm-up period of approximately five minutes may be necessary until an image is displayed. The temperature indicator <TEMP> lights during the warm-up period. When the warm-up is completed, the temperature indicator <TEMP> turns off and the projection starts. Refer to “When an indicator lights up” (➔ page 157) for the indicator status.
- If the operating environment temperature is low and warm-up takes more than five minutes, the projector will judge that a problem has occurred and the power will automatically be set to standby mode. If this happens, increase the operating environment temperature to 0 °C (32 °F) or higher, turn off the main power, and then switch on the projector again.
- If the [PROJECTOR SETUP] menu → [STANDBY MODE] is set to [ECO], it may take approx. 10 seconds longer before the projector starts projecting after the power is turned on, compared with when [NORMAL] is set.
- If the <MAIN POWER> switch was set to <OFF> during projection to end the projection using the direct power off function last time, and the <MAIN POWER> switch is set to <ON> with the power plug connected to the outlet, the power indicator <ON (G)/STANDBY (R)> will light in green and the image will soon be projected on the screen.

## Making adjustments and selections

It is recommended that images are projected continuously for at least 30 minutes before the focus is adjusted.

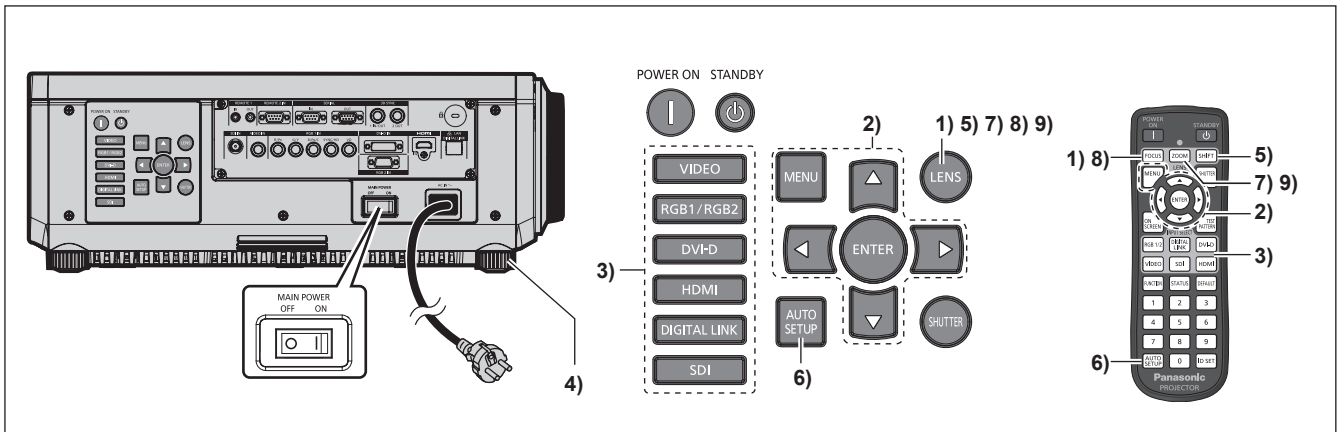

- 1) Press the <FOCUS> button to roughly adjust the focus of the image. (➔ page 58)
- 2) Change the setting of [PROJECTOR SETUP] menu → [PROJECTION METHOD] depending on the installation mode. (➔ page 32)
  - Refer to “Navigating through the menu” (➔ page 65) for the operation of the menu screen.
- 3) Press the input selection (<RGB1/RGB2> or <RGB1/2>, <DIGITAL LINK>, <DVI-D>, <VIDEO>, <SDI>, <HDMI>) button to select the input signal.  
(SDI input is only for PT-DZ870E)
- 4) Adjust the front, back and sideways tilt of the projector with the adjustable feet. (➔ page 46)
- 5) Press the <SHIFT> button to adjust the position of the image.
- 6) If the input signal is an RGB signal, press the <AUTO SETUP> button.
- 7) Press the <ZOOM> button to adjust the size of the image to match the screen.
- 8) Press the <FOCUS> button again to adjust the focus.
- 9) Press the <ZOOM> button again to adjust the zoom and the size of the image to match the screen.

### Note

- When the projector is switched on for the first time after purchase as well as when [ALL USER DATA] in the [PROJECTOR SETUP] menu → [INITIALIZE] is executed, the focus adjustment screen is displayed after projection starts, then the initial setting screen is displayed. Refer to “Start-up display” (➔ page 22) for details.

## Switching off the projector

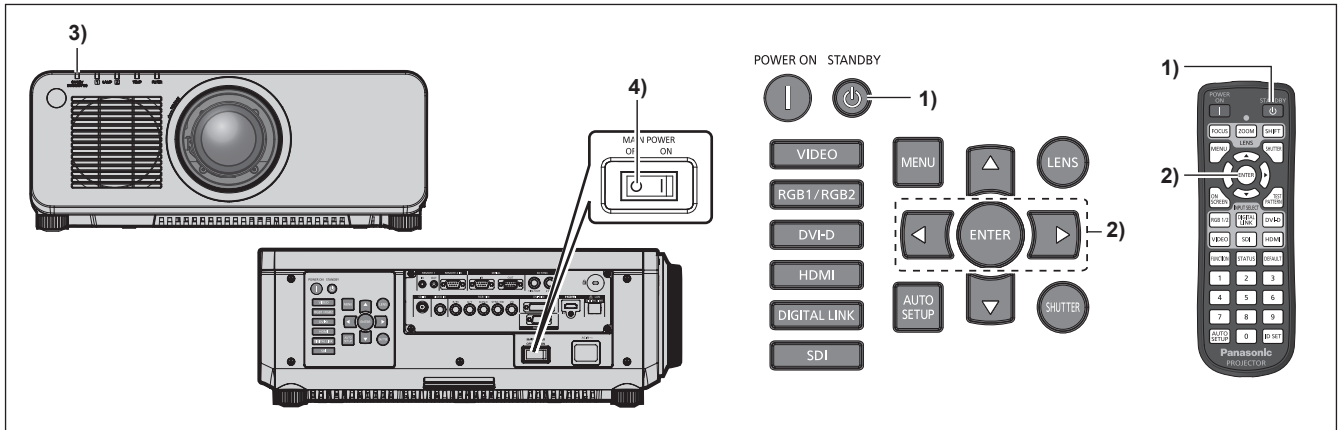

- 1) **Press the power standby <⏻> button.**
  - The [POWER OFF(STANDBY)] confirmation screen is displayed.
- 2) **Press <◀▶> to select [OK], and press the <ENTER> button.**  
**(Or press the power standby <⏻> button again.)**
  - Projection of the image will stop, and the power indicator <ON (G)/STANDBY (R)> on the projector body lights in orange. (The fan keeps running.)
- 3) **Wait until the power indicator <ON (G)/STANDBY (R)> on the projector body lights in red (and the fan stops) for 170 seconds.**
- 4) **Press the <OFF> side of the <MAIN POWER> switch to turn off the power.**

### Note

- Do not switch on the projector and project images immediately after switching off the projector. Turning on the power while the lamp is still hot may shorten the lamp life.
- For about 75 seconds after the projector is switched off and the luminous lamp cooling is started, the lamp indicators will not light up even if the power is switched on. Even after 75 seconds, the lamp may not light up if the projector is switched on. In such a case, after the power indicator <ON (G)/STANDBY (R)> lights in red, switch on the projector again.
- **The projector consumes power even when the power standby <⏻> button is pressed and the projector is switched off if the main power of the projector is on.**  
 When the [PROJECTOR SETUP] menu → [STANDBY MODE] is set to [ECO], use of some functions is restricted, but the power consumption during standby can be conserved.

## Direct power off function

Even if the main power <MAIN POWER> switch is turned <OFF> during projection or immediately after turning off the luminous lamp, the fan runs using internally stored power to cool the luminous lamp. When the projector is mounted on the ceiling or installed in an environment where the main power <MAIN POWER> switch of the projector cannot be easily turned <OFF>, the power can be turned off directly using the circuit breaker. It is also safe in case a power outage occurs or the power cord is pulled out immediately after the projector is switched off.

### Note

- If the projector was turned off by turning off the circuit breaker directly during projection last time, then the power indicator <ON (G)/STANDBY (R)> will light in green a while after the circuit breaker is turned on, and then projection of the image will start.
- If cooled with the direct power off function, projection may take a longer time than usual to start when the projector is switched on the next time.
- Make sure that the fan is not running when packing the projector for transportation or storage.

# Projecting

Check the projection lens attachment (➔ page 48), external device connection (➔ page 49), power cord connection (➔ page 54), switch on the power (➔ page 55) to start projecting. Select the video for projection, and adjust appearance of the projected image.

## Selecting the input signal

Select an input signal.

- 1) **Press the input selection (<RGB1/RGB2> or <RGB1/2>, <DIGITAL LINK>, <DVI-D>, <VIDEO>, <SDI>, <HDMI>) buttons on the remote control or the control panel.**
  - The image of the signal being input in the selected terminal is projected.

### Attention

- Images may not be projected properly depending on the external device, or the blu-ray disc or DVD disc, to be played back. Set the [PICTURE] menu → [SYSTEM SELECTOR].
- Confirm the aspect ratio of the projection screen and the image, and switch to an optimum aspect ratio from the [POSITION] menu → [ASPECT].

## Adjusting the focus, zoom, and shift

If the projected image or the position is not correct when the positioning of the projector and the screen is correctly installed, adjust the focus, zoom, and shift.

### Using the control panel

- 1) **Press the <LENS> button on the control panel.**
  - Pressing the button changes the adjustment screen in the order of [FOCUS], [ZOOM], and [SHIFT].
- 2) **Select each item and press ▲▼◀▶ to adjust it.**

### Using the remote control

- 1) **Press the lens (<FOCUS>, <ZOOM>, <SHIFT>) buttons on the remote control.**
  - <FOCUS> button: Adjusts focus.
  - <ZOOM> button: Adjusts zoom.
  - <SHIFT> button: Adjusts shift.
- 2) **Select each item and press ▲▼◀▶ to adjust it.**

## Caution

**During the lens shift operation, do not insert your hand in any opening around the lens.**  
Your hand may be caught and result in injuries.

### Note

- When the projection lens without the zoom function is attached, the zoom adjustment screen will be displayed. However, operation is not possible.
- Use the fixed-focus lens (Model No.: ET-DLE055) with the lens position set to the home position. (➔ page 59)
- The adjustment can be performed quickly by pressing and holding ▲▼◀▶ for at least three seconds.
- It is recommended that images be projected continuously for at least 30 minutes before the focus is adjusted.
- Only [FOCUS] is shown in yellow so that the displayed menu item can be recognized by color, even when the projector is not focused and displayed characters are unreadable. (Factory default)  
The display color of [FOCUS] depends on the setting of the [DISPLAY OPTION] menu → [ON-SCREEN DISPLAY] → [OSD DESIGN].
- When the projector is switched off during the shift adjustment, lens calibration needs to be performed the next time the projector is switched on. (➔ page 122)
- When the main power is switched off during shift adjustment, a lens calibration error screen will be displayed during the next shift adjustment. Execute the [PROJECTOR SETUP] menu → [LENS CALIBRATION].
- When the lens calibration error is displayed even though [LENS CALIBRATION] was executed, ask your dealer to repair the unit.

## Moving the lens to the home position

To move the lens to the home position, perform the following procedure.

1) While the [SHIFT] adjustment screen is displayed, press the <DEFAULT> button on the remote control.

- The [HOME POSITION] screen is displayed.



2) While the [HOME POSITION] screen is displayed (for approximately five seconds), press the <ENTER> button.

- [PROGRESS] is displayed in the [HOME POSITION] screen, and the lens returns to the home position.

### Note

- The home position of the lens is the lens position when the lens is being replaced or when the projector is being stored, and it is not the optical center of the screen.
- You can also display the [HOME POSITION] screen by pressing the <LENS> button on the control panel or the <SHIFT> button on the remote control for at least three seconds.

## Adjustment range by the lens position shift (optical shift)

Perform the lens position shift within the adjustment range.

The focus may change when the lens position is shifted out of the adjustment range. This is because the movement of the lens is restricted to protect the optical parts. Projection position can be adjusted with the optical axis shift based on the standard projection position in the respective range.

Lens type	Zoom lens	
	Standard zoom lens, ET-DLE150, ET-DLE250, ET-DLE350, ET-DLE450	ET-DLE085
PT-DZ870E	<p>Standard projection position</p>	<p>Standard projection position</p>
PT-DW830E	<p>Standard projection position</p>	<p>Standard projection position</p>

## Chapter 3 Basic Operations — Projecting

Lens type	Zoom lens	
	Standard zoom lens, ET-DLE150, ET-DLE250, ET-DLE350, ET-DLE450	ET-DLE085
PT-DX100E	<p style="text-align: center;">Standard projection position</p> <p style="text-align: center;">Projection screen height V</p> <p style="text-align: center;">Projection screen width H</p>	<p style="text-align: center;">Standard projection position</p> <p style="text-align: center;">Projection screen height V</p> <p style="text-align: center;">Projection screen width H</p>

### Note

- When the optional fixed-focus lens (Model No.: ET-DLE055) is attached, the shift adjustment is not available.



# Operating with the remote control

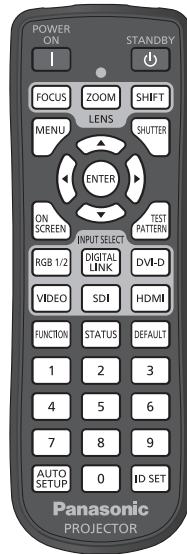

## Using the shutter function

If the projector is not used for a certain period of time during the meeting intermission, for example, it is possible to turn off the image temporarily.



### 1) Press the <SHUTTER> button.

- The image disappears.
- This operation can be also performed using the <SHUTTER> button on the control panel.

### 2) Press the <SHUTTER> button again.

- The image is displayed.

#### Note

- The power indicator <ON (G)/STANDBY (R)> will flash slowly in green while the shutter is closed .
- You can set the speed of shutter opening/closing via the [DISPLAY OPTION] menu → [SHUTTER SETTING].

## Using the on-screen display function

Turn off the on-screen display function (no display) when you do not wish the viewers to see the on-screen display, such as the menu or the input terminal name.



### 1) Press the <ON SCREEN> button.

- The on-screen display disappears.

### 2) Press the <ON SCREEN> button again.

- The on-screen display appears.

#### Note

- If you press the <MENU> button on the control panel for at least three seconds while the on-screen display is off (hidden), the on-screen display is turned on.

## Switching the input signal

The input for projection can be switched.

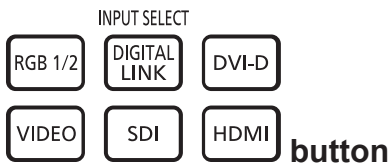

**1) Press the input selection (<RGB1/2>, <DIGITAL LINK>, <DVI-D>, <VIDEO>, <SDI>, <HDMI>) buttons.**

- This operation can be also performed using the buttons on the control panel.

<RGB1/2>	Switches the input to RGB1 or RGB2. Switches to another input when one input has already been chosen.
<DIGITAL LINK>	Switches the input to DIGITAL LINK.
<DVI-D>	Switches the input to DVI-D.
<VIDEO>	Switch the input to VIDEO.
<SDI>*1	Switches the input to SDI.
<HDMI>	Switch the input to HDMI.

\*1 Only for PT-DZ870E

### Note

- When the optional Digital Interface Box (Model No.: ET-YFB100G) is connected to the <DIGITAL LINK/LAN> terminal, the ET-YFB100G input changes with each press of the <DIGITAL LINK> button. The ET-YFB100G input does not change when 3D signals are input from ET-YFB100G. In such a case, either change the input signal from 3D to 2D or change the input using the button on ET-YFB100G. The input can also be changed using the control command of RS-232C.  
For twisted-pair-cable transmitters of other manufacturers, switch the input on the projector to DIGITAL LINK, and then switch the input on the twisted-pair-cable transmitter.

## Using the status function

You can display the status of the projector.



**1) Press the <STATUS> button.**

- The [STATUS] screen is displayed.

STATUS		1/5
INPUT	RGB2	
SIGNAL NAME	SXGA60+-A1	
SIGNAL FREQUENCY	65.22kHz/ 59.99Hz	
PROJECTOR RUNTIME	1h	
LAMP1	11h/ ON/	
LAMP2	1h/ ON/	
INTAKE AIR TEMP.	31°C/ 87°F	
OPTICS MODULE TEMP.	27°C/ 80°F	
AROUND LAMP TEMP.	31°C/ 87°F	
[ENTER] SEND STATUS VIA E-MAIL [LEFT] CHANGE [MENU] EXIT		

### Note

- This can be displayed from the [PROJECTOR SETUP] menu → [STATUS] (➔ page 119).

## Using the automatic setup function

The automatic setup function can be used to automatically adjust the resolution, clock phase, and image position when analog RGB signals consisting of bitmap images such as computer signals are being input, or to automatically adjust the image position when DVI-D/HDMI signals are input. Supplying images with bright white borders at the edges and high-contrast black and white characters is recommended when the system is in automatic adjustment mode.

Avoid supplying images that include halftones or gradation, such as photographs and computer graphics.



**button**

### 1) Press the <AUTO SETUP> button.

- [COMPLETE] is displayed when it has completed without any problem.
- This operation can be also performed using the <AUTO SETUP> button on the control panel.

### Note

- The clock phase may shift even if it has completed without any incident. In such cases, adjust the [POSITION] menu → [CLOCK PHASE] (➔ page 80).
- If an image with blurred edges or a dark image is input, [INCOMPLETE] may appear or adjustment may not be performed properly even when [COMPLETE] appears. In this case, adjust the settings in the [ADVANCED MENU] menu → [INPUT RESOLUTION] (➔ page 85), [POSITION] → [CLOCK PHASE] (➔ page 80), and [SHIFT] (➔ page 78).
- Adjust special signals according to the [DISPLAY OPTION] menu → [AUTO SETUP] (➔ page 97).
- Automatic adjustment may not work depending on the model of the computer.
- Automatic adjustment may not work for a synchronization signal of C-SY or SYNC ON GREEN.
- Images may be disrupted for a few seconds during automatic adjustment, but it is not a malfunction.
- Adjustment is required for each input signal.
- Automatic adjustment can be canceled by pressing the <MENU> button during the automatic adjustment operation.
- If the automatic setup function is used while moving images are being input, the adjustment may not be performed properly even for an RGB signal that can use automatic setup. [INCOMPLETE] may appear, or adjustment may not be finished properly even if [COMPLETE] appears.

## Using the function button

[P IN P], [SUB MEMORY], [SYSTEM SELECTOR], [SYSTEM DAYLIGHT VIEW], [FREEZE], [WAVEFORM MONITOR], [LEFT/RIGHT SWAP], or [ASPECT] operations can be assigned to the <FUNCTION> button on the remote control so that it can be used as an easy shortcut button.



**button**

### 1) Press the <FUNCTION> button.

### Note

- Assignment of the function is performed from the [PROJECTOR SETUP] menu → [FUNCTION BUTTON] (➔ page 121).

## Displaying the internal test pattern

The projector has eight types of internal test patterns to check the condition of the set. To display test patterns, perform the following steps.



**button**

### 1) Press the <TEST PATTERN> button.

### 2) Press ◀▶ to select the test pattern.

### Note

- Setting is also available from the [TEST PATTERN] (➔ page 126) menu.
- Settings of position, size, and other factors will not be reflected in test patterns. Make sure to display the input signal before performing various adjustments.

# Chapter 4 Settings

---

This chapter describes the settings and adjustments you can make using the on-screen menu.

# Menu navigation

The on-screen menu (Menu) is used to perform various settings and adjustments of the projector.

## Navigating through the menu

### Operating procedure



**1) Press the <MENU> button on the remote control or control panel.**

- The [MAIN MENU] screen is displayed.

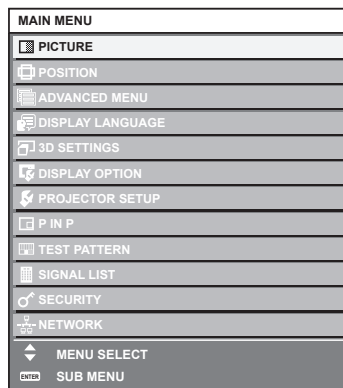

**2) Press ▲▼ to select an item from the main menu.**

- The selected item is highlighted in yellow.

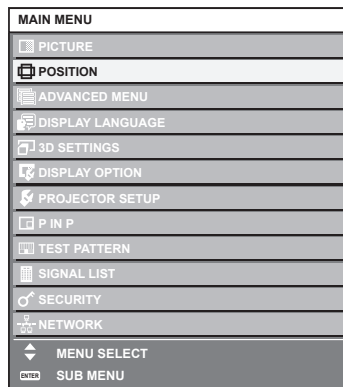

**3) Press the <ENTER> button.**

- The sub-menu items of the selected main menu are displayed.

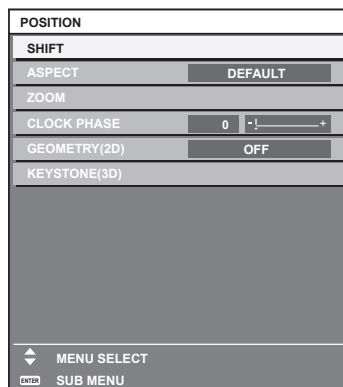

4) Press ▲▼ to select a sub-menu, and press ◀▶ or the <ENTER> button to change or adjust settings.

- Some items will switch in order as follows each time you press ◀▶.

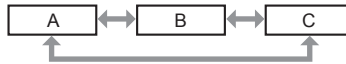

- For some items, press ◀▶ to display an individual adjustment screen with a bar scale as shown below.



**Note**

- Pressing the <MENU> button while the menu screen is displayed returns to the previous menu.
- Some items may not be adjusted or used for certain signal formats to be input to the projector. The menu items that cannot be adjusted or used are shown in black characters, and they cannot be selected. [DIGITAL CINEMA REALITY] and [FRAME LOCK] may not be displayed depending on the input signal.
- Some items can be adjusted even if signals are not input.
- Individual adjustment screen is cleared automatically if no operation is performed for approximately five seconds.
- For menu items, refer to “Main menu” (➔ page 66) and “Sub-menu” (➔ page 67).
- The cursor color depends on the settings of the [DISPLAY OPTION] menu → [ON-SCREEN DISPLAY] → [OSD DESIGN]. The selected item is displayed with the yellow cursor by the factory default.

**Resetting adjustment values to the factory default**

If the <DEFAULT> button on the remote control is pressed, the values adjusted in the menu items are restored to the factory default settings.



1) Press the <DEFAULT> button on the remote control.



**Note**

- You cannot reset all the settings to the factory default at a time.
- To reset all the settings adjusted in the sub-menu item to the factory default one at a time, execute [PROJECTOR SETUP] menu → [INITIALIZE] (➔ page 123).
- Some items cannot be reset to the factory defaults by pressing the <DEFAULT> button on the remote control. Adjust each item manually.
- The triangular mark under the bar scale in the individual adjustment screen indicates the factory default setting. The position of the triangular mark varies according to the selected input signals.

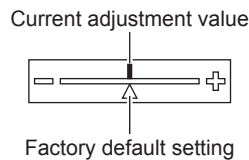







**Main menu**

The following items are in the main menu.

When a main menu item is selected, the screen changes to a sub-menu selection screen.

Main menu item		Page
	[PICTURE]	71
	[POSITION]	78
	[ADVANCED MENU]	84
	[DISPLAY LANGUAGE]	89
	[3D SETTINGS]	90
	[DISPLAY OPTION]	95

Main menu item		Page
	[PROJECTOR SETUP]	108
	[P IN P]	124
	[TEST PATTERN]	126
	[SIGNAL LIST]	127
	[SECURITY]	130
	[NETWORK]	134

## Sub-menu

The sub-menu of the selected main menu item is displayed, and you can set and adjust items in the sub-menu.

### [PICTURE]

Sub-menu item	Factory default	Page
[PICTURE MODE]	[STANDARD]*1	71
[CONTRAST]	[0]	71
[BRIGHTNESS]	[0]	71
[COLOR]	[0]	72
[TINT]	[0]	72
[COLOR TEMPERATURE]	[DEFAULT]	72
[WHITE GAIN]	[+10]	74
[GAMMA]	[DEFAULT]	74
[SYSTEM DAYLIGHT VIEW]	[OFF]	74
[SHARPNESS]	[+6]	75
[NOISE REDUCTION]	[OFF]	75
[DYNAMIC IRIS]	[2]	75
[SYSTEM SELECTOR]	[Y <sub>B</sub> P <sub>R</sub> ]*1	76

\*1 Depends on the signal input.

### Note

- The factory default settings may vary depending on the picture mode.

### [POSITION]

Sub-menu item	Factory default	Page
[SHIFT]	—	78
[ASPECT]	[DEFAULT]*1	78
[ZOOM]	—	79
[CLOCK PHASE]	[0]*1	80
[GEOMETRY(2D)]*2	[OFF]	80
[KEystone(3D)]*2	—	82
[KEystone]*3	—	83

\*1 Depends on the signal input.

\*2 Only for PT-DZ870E

\*3 Only for PT-DW830E, PT-DX100E

### [ADVANCED MENU]

Sub-menu item	Factory default	Page
[DIGITAL CINEMA REALITY]	[AUTO]*1	84
[BLANKING]	—	84

Sub-menu item	Factory default	Page
[INPUT RESOLUTION]	—	85
[CLAMP POSITION]	[24] <sup>*1</sup>	85
[EDGE BLENDING]	[OFF]	86
[FRAME RESPONSE]	[NORMAL]	87
[FRAME LOCK]	[OFF]	88
[RASTER POSITION]	—	88

\*1 Depends on the signal input.

**Note**

- Sub-menu items and factory default settings vary depending on the selected input terminal.

**[DISPLAY LANGUAGE]** 

Details (➔ page 89)

**[3D SETTINGS]** 

Sub-menu item	Factory default	Page
[3D SYSTEM SETTING]	[SINGLE]	90
[DLP Link]	[ON]	90
[3D SYNC SETTING]	—	90
[3D SIMUL INPUT SETTING]	—	91
[3D INPUT FORMAT]	[AUTO] <sup>*1</sup>	91
[3D 24Hz IMAGE PROJECTION] <sup>*2</sup>	[144fps]	92
[3D 24Hz IMAGE POSITION] <sup>*2</sup>	[0]	92
[LEFT/RIGHT SWAP]	[NORMAL]	92
[SUB CLOCK PHASE]	[0] <sup>*1</sup>	93
[3D FRAME DELAY]	[0us]	93
[3D TEST MODE]	[NORMAL]	93
[3D TEST PATTERN]	—	93
[SAFETY PRECAUTIONS MESSAGE]	[ON]	94
[3D SAFETY PRECAUTIONS]	—	94

\*1 Varies depending on the selected input terminal.

\*2 Only for PT-DZ870E

**[DISPLAY OPTION]** 

Sub-menu item	Factory default	Page
[COLOR MATCHING]	[OFF]	95
[COLOR CORRECTION]	[OFF]	96
[SCREEN SETTING]	—	96
[AUTO SIGNAL]	[OFF]	97
[AUTO SETUP]	—	97
[RGB IN]	—	98
[DVI-D IN]	—	98
[HDMI IN]	—	99
[DIGITAL LINK IN]	—	99
[SDI IN] <sup>*1</sup>	—	100
[ON-SCREEN DISPLAY]	—	101
[CLOSED CAPTION SETTING]	—	102
[BACK COLOR]	[BLUE]	103
[STARTUP LOGO]	[DEFAULT LOGO]	103
[UNIFORMITY]	—	103
[SHUTTER SETTING]	—	104
[FREEZE]	—	105
[WAVEFORM MONITOR]	[OFF]	105



Sub-menu item	Factory default	Page
[CUT OFF]	—	106

\*1 Only for PT-DZ870E

## [PROJECTOR SETUP]

Sub-menu item	Factory default	Page
[PROJECTOR ID]	[ALL]	108
[PROJECTION METHOD]	[FRONT/FLOOR]	108
[COOLING CONDITION]	[AUTO]	109
[HIGH ALTITUDE MODE]	[OFF]	109
[LAMP SELECT]	[DUAL]	109
[LAMP RELAY]	[OFF]	110
[LAMP POWER]	[NORMAL]	111
[BRIGHTNESS CONTROL]	—	111
[STANDBY MODE]	[ECO]	116
[SCHEDULE]	[OFF]	116
[STARTUP INPUT SELECT]	[LAST USED]	117
[RS-232C]	—	118
[STATUS]	—	119
[NO SIGNAL SHUT-OFF]	[DISABLE]	120
[REMOTE2 MODE]	[DEFAULT]	121
[FUNCTION BUTTON]	—	121
[DATE AND TIME]	—	121
[LENS CALIBRATION]	—	122
[SAVE ALL USER DATA]	—	122
[LOAD ALL USER DATA]	—	123
[INITIALIZE]	—	123
[SERVICE PASSWORD]	—	123

## [P IN P]

Details (➔ page 124)

## [TEST PATTERN]

Details (➔ page 126)

## [SIGNAL LIST]

Details (➔ page 127)

## [SECURITY]

Sub-menu item	Factory default	Page
[SECURITY PASSWORD]	[OFF]	130
[SECURITY PASSWORD CHANGE]	—	130
[DISPLAY SETTING]	[OFF]	131
[TEXT CHANGE]	—	131
[CONTROL DEVICE SETUP]	—	131
[CONTROL DEVICE PASSWORD CHANGE]	—	133

**[NETWORK]** 

Sub-menu item	Factory default	Page
[DIGITAL LINK MODE]	[AUTO]	134
[DIGITAL LINK SETUP]	—	134
[DIGITAL LINK STATUS]	—	135
[NETWORK SETUP]	—	135
[NETWORK CONTROL]	—	136
[NETWORK STATUS]	—	136
[DIGITAL INTERFACE BOX]	—	136
[Art-Net SETUP]	—	136

**Note**

- Some items may not be adjusted or used for certain signal formats to be input to the projector.  
The menu items that cannot be adjusted or used are shown in black characters, and they cannot be selected.
- Sub-menu items and factory default settings vary depending on the selected input terminal.

## [PICTURE] menu

On the menu screen, select [PICTURE] from the main menu, and select an item from the sub-menu.

Refer to “Navigating through the menu” (➔ page 65) for the operation of the menu screen.

- After selecting the item, press ▲▼◀▶ to adjust.



### [PICTURE MODE]

You can switch to the desired picture mode suitable for the image source and the environment in which the projector is used.

- 1) Press ▲▼ to select [PICTURE MODE].
- 2) Press ◀▶ or the <ENTER> button.
  - The [PICTURE MODE] individual adjustment screen is displayed.
- 3) Press ◀▶ to switch the item.
  - The items will switch each time you press the button.

[STANDARD]	The image becomes suitable for moving images in general.
[CINEMA]	The image becomes suitable for movie contents.
[NATURAL]	The image is sRGB compliant.
[REC709]*1	The image becomes Rec.709 compliant.
[DICOM SIM.]	The image becomes similar to that of DICOM Part 14 Grayscale Standard.
[DYNAMIC]	The light output is maximized for use in bright areas.
[GRAPHIC]	The image becomes suitable for input from the personal computer.

\*1 Use the factory default setting for the settings other than [PICTURE MODE].

#### Note

- The factory default picture mode is [GRAPHIC] for still image input signals and [STANDARD] for movie-based input signals.
- Rec.709 is an abbreviation of “ITU-R Recommendation BT.709” and is a color standard of high-definition television.
- DICOM is an abbreviation of “Digital Imaging and COmmunication in Medicine” and is a standard for medical imaging devices. Although the DICOM name is used, the projector is not a medical device, and should not be used for purposes such as diagnosis of display images.

### [CONTRAST]

You can adjust the contrast of the colors.

- 1) Press ▲▼ to select [CONTRAST].
- 2) Press ◀▶ or the <ENTER> button.
  - The [CONTRAST] individual adjustment screen is displayed.
- 3) Press ◀▶ to adjust the level.

Operation	Adjustment	Range of adjustment
Press the ▶ button.	The screen becomes brighter.	-31 - +31
Press the ◀ button.	The screen becomes darker.	

#### Attention

- Adjust [BRIGHTNESS] first when you need to adjust the black level.

### [BRIGHTNESS]

You can adjust the dark (black) part of the projected image.

- 1) Press ▲▼ to select [BRIGHTNESS].

2) Press ◀▶ or the <ENTER> button.

- The [BRIGHTNESS] individual adjustment screen is displayed.

3) Press ◀▶ to adjust the level.

Operation	Adjustment	Range of adjustment
Press the ▶ button.	Increases the brightness of the dark (black) parts of the screen.	-31 - +31
Press the ◀ button.	Reduces the brightness of the dark (black) parts of the screen.	

## [COLOR]

You can adjust the color saturation of the projected image.

1) Press ▲▼ to select [COLOR].

2) Press ◀▶ or the <ENTER> button.

- The [COLOR] individual adjustment screen is displayed.

3) Press ◀▶ to adjust the level.

Operation	Adjustment	Range of adjustment
Press the ▶ button.	Deepens colors.	-31 - +31
Press the ◀ button.	Weakens colors.	

## [TINT]

You can adjust the skin tone in the projected image.

1) Press ▲▼ to select [TINT].

2) Press ◀▶ or the <ENTER> button.

- The [TINT] individual adjustment screen is displayed.

3) Press ◀▶ to adjust the level.

Operation	Adjustment	Range of adjustment
Press the ▶ button.	Adjusts skin tone toward greenish color.	-31 - +31
Press the ◀ button.	Adjusts skin tone toward reddish purple.	

## [COLOR TEMPERATURE]

You can switch the color temperature if the white areas of the projected image are bluish or reddish.

### Adjusting with color temperature

1) Press ▲▼ to select [COLOR TEMPERATURE].

2) Press ◀▶ or the <ENTER> button.

- The [COLOR TEMPERATURE] individual adjustment screen is displayed.

3) Press ◀▶ to switch the item.

- The items will switch each time you press the button.

[DEFAULT]	Factory default setting.
[USER1]	Adjusts white balance as desired. Refer to "Adjusting desired white balance" (► page 73) for details.
[USER2]	
[3200K] - [9300K]	Allows you to set in increments of 100 K. Select so that images become natural.

### Note

- When [PICTURE MODE] (► page 71) is set to [DICOM SIM.], [DEFAULT] cannot be selected.
- When [COLOR MATCHING] (► page 95) adjustment is set to other than [OFF], [COLOR TEMPERATURE] is fixed to [USER1].
- The color temperature numerical values are guidelines.

### Adjusting desired white balance

- 1) Press ▲▼ to select [COLOR TEMPERATURE].
- 2) Press ◀▶ or the <ENTER> button.
  - The [COLOR TEMPERATURE] individual adjustment screen is displayed.
- 3) Press ◀▶ to select [USER1] or [USER2].
- 4) Press the <ENTER> button.
  - The [COLOR TEMPERATURE] screen is displayed.
- 5) Press ▲▼ to select [WHITE BALANCE].
- 6) Press the <ENTER> button.
  - The [WHITE BALANCE] screen is displayed.
- 7) Press ▲▼ to select [WHITE BALANCE HIGH] or [WHITE BALANCE LOW].
- 8) Press the <ENTER> button.
  - The [WHITE BALANCE HIGH] screen or the [WHITE BALANCE LOW] screen is displayed.
- 9) Press ▲▼ to select [RED], [GREEN], or [BLUE].
- 10) Press ◀▶ to adjust the level.

Item	Operation	Adjustment	Range of adjustment
[RED]	Press the ▶ button.	Deepens red.	[WHITE BALANCE HIGH]: 0 - +255 (factory default is +255) [WHITE BALANCE LOW]: -127 - +127 (factory default is 0)
	Press the ◀ button.	Weakens red.	
[GREEN]	Press the ▶ button.	Deepens green.	
	Press the ◀ button.	Weakens green.	
[BLUE]	Press the ▶ button.	Deepens blue.	
	Press the ◀ button.	Weakens blue.	

#### Note

- Adjust [COLOR TEMPERATURE] correctly. All colors will not be displayed properly unless adequate adjustment is made. If the adjustment does not look suitable, you can press the <DEFAULT> button on the remote control to return the setting for the selected item only to the factory default setting.

### Adjusting desired white balance based on existing color temperature settings

- 1) Press ▲▼ to select [COLOR TEMPERATURE].
- 2) Press ◀▶ or the <ENTER> button.
  - The [COLOR TEMPERATURE] individual adjustment screen is displayed.
- 3) Press ◀▶ to select a setting other than [DEFAULT], [USER1], or [USER2].
- 4) Press the <ENTER> button.
  - The [CHANGE TO \*\*\*\*\*] screen is displayed.
- 5) Press ▲▼ to select [USER1] or [USER2].
  - The status of the color temperature changed is saved to the selected item.
- 6) Press the <ENTER> button.
  - The confirmation screen is displayed.
- 7) Press ◀▶ to select [OK], and press the <ENTER> button.
  - The [USER1] or [USER2] data is overwritten.
  - If you press ◀▶ to select [CANCEL] and then press the <ENTER> button, the data will not be overwritten.
  - The [WHITE BALANCE HIGH] screen is displayed.
- 8) Press ▲▼ to select [RED], [GREEN], or [BLUE].
- 9) Press ◀▶ to adjust the level.

**Note**

- Adjust [COLOR TEMPERATURE] correctly. All colors will not be displayed properly unless adequate adjustment is made. If the adjustment does not look suitable, you can press the <DEFAULT> button on the remote control to return the setting for the selected item only to the factory default setting.
- When color temperature has been changed, the colors before and after the change will differ slightly.

**Changing the name of [USER1] or [USER2]**

- 1) Press ▲▼ to select [COLOR TEMPERATURE].
- 2) Press ◀▶ or the <ENTER> button.
  - The [COLOR TEMPERATURE] individual adjustment screen is displayed.
- 3) Press ◀▶ to select [USER1] or [USER2].
- 4) Press the <ENTER> button.
  - The [COLOR TEMPERATURE] screen is displayed.
- 5) Press ▲▼ to select [COLOR TEMPERATURE NAME CHANGE].
- 6) Press the <ENTER> button.
  - The [COLOR TEMPERATURE NAME CHANGE] screen is displayed.
- 7) Press ▲▼◀▶ to select the text, and press the <ENTER> button to enter the text.
- 8) Press ▲▼◀▶ to select [OK], and press the <ENTER> button.
  - The name set to color temperature is changed.

**Note**

- When a name is changed, display of [USER1], [USER2] is also changed.

**[WHITE GAIN]**

Adjusts the brightness of the white part of the projected image.

- 1) Press ▲▼ to select [WHITE GAIN].
- 2) Press ◀▶ or the <ENTER> button.
  - The [WHITE GAIN] individual adjustment screen is displayed.
- 3) Press ◀▶ to adjust the level.

Operation	Adjustment	Range of adjustment
Press ▶.	Brightness of the white part gets stronger.	0 - +10
Press ◀.	The image becomes more natural.	

**[GAMMA]**

You can switch gamma mode.

- 1) Press ▲▼ to select [GAMMA].
- 2) Press ◀▶ or the <ENTER> button.
  - The [GAMMA] individual adjustment screen is displayed.
- 3) Press ◀▶ to switch the item.
  - The items will switch each time you press the button.

[DEFAULT]	Factory default setting.
[1.8]	Set so that images become as you like.
[2.0]	
[2.2]	

**[SYSTEM DAYLIGHT VIEW]**

You can correct the image to the optimal vividness even if it is projected under a bright light.

- 1) Press ▲▼ to select [SYSTEM DAYLIGHT VIEW].
- 2) Press ◀▶ or the <ENTER> button.
  - The [SYSTEM DAYLIGHT VIEW] individual adjustment screen is displayed.
- 3) Press ◀▶ to switch the item.
  - The items will switch each time you press the button.

[OFF]	No correction.
[1]	Corrects the image to weaken vividness.
[2]	Corrects the image to medium vividness.
[3]	Corrects the image to high vividness.

## [SHARPNESS]

You can adjust the sharpness of the projected image.

- 1) Press ▲▼ to select [SHARPNESS].
- 2) Press ◀▶ or the <ENTER> button.
  - The [SHARPNESS] individual adjustment screen is displayed.
- 3) Press ◀▶ to adjust the level.

Operation	Adjustment	Range of adjustment
Press the ▶ button.	Contours become sharper.	0 - +15
Press the ◀ button.	Contours become softer.	

### Note

- If you press ▶ while the adjustment value is [+15], the value will become [0]. If you press ◀ while the adjustment value is [0], the value will become [+15].

## [NOISE REDUCTION]

You can reduce noises when the input image is degraded and noise is occurring in the image signal.

- 1) Press ▲▼ to select [NOISE REDUCTION].
- 2) Press ◀▶ or the <ENTER> button.
  - The [NOISE REDUCTION] individual adjustment screen is displayed.
- 3) Press ◀▶ to switch the item.
  - The items will switch each time you press the button.

[OFF]	No correction.
[1]	Slightly corrects the noise.
[2]	Moderately corrects the noise.
[3]	Strongly corrects the noise.

### Attention

- When this is set for an input signal with less noise, the image may look different from what it originally was. In such a case, set it to [OFF].

## [DYNAMIC IRIS]

Aperture correction and signal compensation are performed automatically based on the image to result in an image of optimum contrast.

- 1) Press ▲▼ to select [DYNAMIC IRIS].
- 2) Press ◀▶ or the <ENTER> button.
  - The [DYNAMIC IRIS] individual adjustment screen is displayed.
- 3) Press ◀▶ to switch the item.
  - The items will switch each time you press the button.

[OFF]	No correction.
[1]	Slightly corrects aperture and compensate signals.

[2]	Moderately corrects aperture and signal.
[3]	Strongly corrects aperture and signal.
[USER]	Set any desired correction. Refer to “Adjusting desired correction amount” (➔ page 76) for details.

### Adjusting desired correction amount

- 1) Press ▲▼ to select [DYNAMIC IRIS].
- 2) Press ◀▶ or the <ENTER> button.
  - The [DYNAMIC IRIS] individual adjustment screen is displayed.
- 3) Press ◀▶ to select [USER].
- 4) Press the <ENTER> button.
  - The [DYNAMIC IRIS] screen is displayed.
- 5) Press ▲▼ to select [AUTO IRIS], [MANUAL IRIS], or [DYNAMIC GAMMA].
- 6) Press ◀▶ to adjust the correction amount.

Item	Adjustment	
[AUTO IRIS] (Automatic adjustment of aperture)	[OFF]	No correction.
	[1] - [255]	Allows you to set in increments of 1. The larger the value, the stronger the correction.
[MANUAL IRIS] (Fixed adjustment of aperture)	[OFF]	No correction.
	[1] - [255]	Allows you to set in increments of 1. The larger the value, the stronger the correction.
[DYNAMIC GAMMA] (Adjustment of signal compensation)	[OFF]	No correction.
	[1]	Slightly compensates the signal.
	[2]	Moderately compensates the signal.
	[3]	Strongly compensates the signal.

### Note

- When [DYNAMIC GAMMA] is set to [3], the contrast will be maximized.
- Brightness control and dynamic iris operate simultaneously, but the iris is fully open and does not operate while a brightness measurement is performed.
- If [DLP Link] is set to [ON], [DYNAMIC IRIS] is fixed to [OFF] while 3D images are displayed.

### [SYSTEM SELECTOR]

The projector will automatically detect the input signal, but you can set the system method manually when an unstable signal is input. Set the system method matching the input signal.

- 1) Press ▲▼ to select [SYSTEM SELECTOR].
- 2) Press the <ENTER> button.
- 3) Press ▲▼ to select a system format.
  - If inputting signals via the <SDI IN> terminal connection, select the system method by pressing ▲▼◀▶. (Only for PT-DZ870E)
  - Available system formats vary depending on the input signal.

Terminal	System format	
<VIDEO IN> terminal, <G/Y>/<B/P <sub>B</sub> /C> terminals	Select [AUTO], [NTSC], [NTSC4.43], [PAL], [PAL-M], [PAL-N], [SECAM], or [PAL60]. Set it to [AUTO] normally. (Setting [AUTO] will automatically select [NTSC], [NTSC4.43], [PAL], [PAL-M], [PAL-N], [SECAM], or [PAL60].) Switch the setting to the signal method for the TV used.	
<RGB 1 IN> terminal, <RGB 2 IN> terminal	<b>480i, 576i, or 576p signal</b>	Select [RGB] or [Y <sub>C<sub>B</sub>C<sub>R</sub></sub> ].
	<b>VGA60 or 480p signal</b>	Select from [VGA60], [480p Y <sub>C<sub>B</sub>C<sub>R</sub></sub> ], or [480p RGB].
	<b>Other movie-based signals</b>	Select [RGB] or [Y <sub>P<sub>B</sub>P<sub>R</sub></sub> ].
<DVI-D IN> terminal	<b>480i, 576i, 480p, or 576p signal</b>	Select [RGB] or [Y <sub>C<sub>B</sub>C<sub>R</sub></sub> ].
	<b>Other movie-based signals</b>	Select [RGB] or [Y <sub>P<sub>B</sub>P<sub>R</sub></sub> ].



Terminal	System format	
<HDMI IN> terminal, <DIGITAL LINK/LAN> terminal	480i, 576i, 480p, or 576p signal	Select [AUTO], [RGB], or [YCbCr].
	Other movie-based signals	Select [AUTO], [RGB], or [YPbPr].
<SDI IN> terminal (Only for PT-DZ870E)	Select [AUTO], [480i YCbCr], [576i YCbCr], [720/50p YPbPr], [720/60p YPbPr], [1035/60i YPbPr], [1080/24p YPbPr], [1080/24sF YPbPr], [1080/25p YPbPr], [1080/30p YPbPr], [1080/50i YPbPr], [1080/60i YPbPr], [1080/50p YPbPr], [1080/60p YPbPr], [1080/24p RGB], [1080/24sF RGB], [1080/25p RGB], [1080/30p RGB], [1080/50i RGB], or [1080/60i RGB].	

4) Press the <ENTER> button.

**Note**

- Refer to “List of compatible signals” (➔ page 178) for the types of video signals that can be used with the projector.
- This may not function properly for some connected external devices.

**sRGB-compliant video**

sRGB is an international standard (IEC61966-2-1) for color reproduction defined by IEC (International Electrotechnical Commission). Set according to the following steps to reproduce more faithful, sRGB compliant colors.

- 1) Set [COLOR MATCHING] to [OFF].
  - Refer to [COLOR MATCHING] (➔ page 95).
- 2) Display the [PICTURE] menu.
  - Refer to “[PICTURE] menu” (➔ page 71).
- 3) Press ▲▼ to select [PICTURE MODE].
- 4) Press ◀▶ to set [NATURAL].
- 5) Press ▲▼ to select [COLOR].
- 6) Press the <DEFAULT> button on the remote control to set the factory default setting.
- 7) Follow Steps 5) - 6) to set [TINT], [COLOR TEMPERATURE], [WHITE GAIN], [GAMMA], and [SYSTEM DAYLIGHT VIEW] to the factory default settings.

**Note**

- sRGB is available for RGB signal input only.

## [POSITION] menu

On the menu screen, select [POSITION] from the main menu, and select an item from the sub-menu.

Refer to “Navigating through the menu” (➔ page 65) for the operation of the menu screen.

- After selecting the item, press ▲▼◀▶ to adjust.



## [SHIFT]

Move the image position vertically or horizontally if the image position projected on the screen is shifted even when the relative position of the projector and the screen is installed correctly.

- 1) Press ▲▼ to select [SHIFT].
- 2) Press the <ENTER> button.
  - The [SHIFT] screen is displayed.
- 3) Press ▲▼◀▶ to adjust the position.

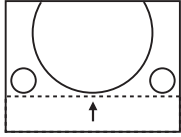
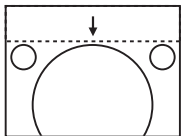
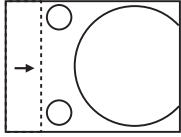
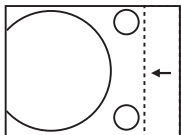
Orientation	Operation	Adjustment
Vertical (up and down) adjustment	Press the ▲ button.	The image position moves up. 
	Press the ▼ button.	The image position moves down. 
Horizontal (right and left) adjustment	Press the ▶ button.	The image position moves to the right. 
	Press the ◀ button.	The image position moves to the left. 

## [ASPECT]

You can switch the aspect ratio of the image.

The aspect ratio is switched within the screen range selected in [SCREEN SETTING]. Set [SCREEN SETTING] first. (➔ page 96)

- 1) Press ▲▼ to select [ASPECT].
- 2) Press ◀▶ or the <ENTER> button.
  - The [ASPECT] individual adjustment screen is displayed.
- 3) Press ◀▶ to switch the item.
  - The items will switch each time you press the button.

[DEFAULT]	Displays images without changing the aspect ratio of the input signals.
-----------	---

[VID AUTO]*1	The projector identifies the video ID (VID) embedded in the video signals and displays the image by automatically switching the screen sizes between 4:3 and 16:9. This function is effective for NTSC signals.
[AUTO]*2	The projector identifies the video ID (VID) embedded in the video signals and displays the image by automatically switching the screen sizes between 4:3 and 16:9. This function is effective for 480i/480p signals.
[THROUGH]	Displays images without changing the resolution of the input signals.
[16:9]	Displays images with the aspect ratio converted to 16:9 when standard signals are input*3. Display images without changing the aspect ratio when wide-screen signals are input*4.
[4:3]	Displays images without changing the aspect ratio when standard signals are input*3. Displays images without changing the aspect ratio so that the images will fit in the 4:3 screen when wide-screen signals are input*2.
[H FIT]	Displays images using the entire width of the screen. When signals have the aspect ratio vertically longer than the aspect ratio of the screen selected in [SCREEN FORMAT], the images are displayed with the top and bottom parts cut off.
[V FIT]	Displays images using the entire height of the screen range selected in [SCREEN FORMAT]. When signals have the aspect ratio horizontally longer than the aspect ratio of the screen selected in [SCREEN FORMAT], the images are displayed with the right and left parts cut off.
[HV FIT]	Displays images in the entire screen range selected in [SCREEN FORMAT]. When the aspect ratio of the input signals differs from that of the screen range, the images are displayed with the aspect ratio converted to that of the screen selected in [SCREEN FORMAT].

\*1 For video signals and Y/C signals (NTSC) only

\*2 For RGB (480i or 480p) signal input only

\*3 Standard signals are input signals with an aspect ratio of 4:3 or 5:4.

\*4 Wide-screen signals are input signals with an aspect ratio of 16:10, 16:9, 15:9 or 15:10.

### Note

- Some size modes are not available for certain types of input signals. [DEFAULT] cannot be selected for video signal, Y/C signal (NTSC), or RGB (480i, 480p) signal.
- If an aspect ratio which is different from the aspect ratio for the input signals is selected, the images will appear differently from the originals. Be careful of this when selecting the aspect ratio.
- If using the projector in places such as cafes or hotels to display programs for a commercial purpose or for public presentation, note that adjusting the aspect ratio or using the zoom function to change the screen images may be an infringement of the rights of the original copyright owner for that program under copyright protection laws. Take care when using a function of the projector such as the aspect ratio adjustment and zoom function.
- If conventional (normal) 4:3 images which are not wide-screen images are displayed on a wide screen, the edges of the images may not be visible or they may become distorted. Such images should be viewed as with an aspect ratio of 4:3 in the original format intended by the creator of the images.

### [ZOOM]

You can adjust the image size.

#### When [ASPECT] is set to other than [DEFAULT] and [THROUGH]

- 1) Press ▲▼ to select [ZOOM].
- 2) Press the <ENTER> button.
  - The [ZOOM] screen is displayed.
- 3) Press ▲▼ to select [INTERLOCKED].
- 4) Press ◀▶ to switch the item.

[OFF]	Sets the [VERTICAL] and [HORIZONTAL] zoom ratio.
[ON]	Uses [BOTH] to set zoom ratio. Image can be enlarged or reduced vertically and horizontally at the same magnification.

- 5) Press ▲▼ to select [VERTICAL] or [HORIZONTAL].
  - If [ON] is selected, select [BOTH].
- 6) Press ◀▶ to adjust.

### Note

- When [ASPECT] is set to [THROUGH], [ZOOM] cannot be adjusted.

**When [ASPECT] is set to [DEFAULT]**

- 1) Press ▲▼ to select [ZOOM].
- 2) Press the <ENTER> button.
  - The [ZOOM] screen is displayed.
- 3) Press ▲▼ to select [MODE].
- 4) Press ◀▶ to switch the item.

[INTERNAL]	Enlarges the size within the aspect range set with [SCREEN FORMAT].
[FULL]	Enlarges or reduces the size using the entire display area set with [SCREEN FORMAT].

- 5) Press ▲▼ to select [INTERLOCKED].
- 6) Press ◀▶ to switch the item.

[OFF]	Sets the [VERTICAL] and [HORIZONTAL] zoom ratio.
[ON]	Uses [BOTH] to set zoom ratio. Image can be enlarged or reduced vertically and horizontally at the same magnification.

- 7) Press ▲▼ to select [VERTICAL] or [HORIZONTAL].
  - If [ON] is selected, select [BOTH].
- 8) Press ◀▶ to adjust.

**Note**

- When [ASPECT] is not set to [DEFAULT], [MODE] is not displayed.

**[CLOCK PHASE]**

You can adjust to achieve an optimal image when there is a flickering image or smeared outlines.

- 1) Press ▲▼ to select [CLOCK PHASE].
- 2) Press ◀▶ or the <ENTER> button.
  - The [CLOCK PHASE] individual adjustment screen is displayed.
- 3) Press ◀▶ to adjust.
  - Adjustment value will change between [0] and [+31]. Adjust so that the amount of interference is at a minimum.

**Note**

- Certain signals may not be adjustable.
- Optimal value may not be achieved if the output from the input computer is unstable.
- Optimal value may not be achieved when there is a shift in the total dot numbers.
- [CLOCK PHASE] can be adjusted only when a signal is input to the <RGB 1 IN> terminal or the <RGB 2 IN> terminal.
- [CLOCK PHASE] cannot be adjusted when a digital signal is input.
- If you press ▶ while the adjustment value is [+31], the value will become [0]. If you press ◀ while the adjustment value is [0], the value will become [+31].

**[GEOMETRY(2D)]**

(Only for PT-DZ870E)

You can correct various types of distortion in a projected image.

Unique image processing technology enables projection of a square image on a special screen shape.

- 1) Press ▲▼ to select [GEOMETRY(2D)].
- 2) Press ◀▶ to switch the item.
  - The items will switch each time you press the button.

[OFF]	Does not perform geometric adjustment.
[KEystone]	Adjusts any trapezoidal distortion in the projected image.
[CORNER CORRECTION]	Adjusts any distortion in the four corners of the projected image.
[CURVED]	Adjusts any curved distortion in the projected image.

[PC-1]*1	Uses the computer to perform geometric adjustment.
[PC-2]*1	
[PC-3]*1	

\*1 Advanced skills are necessary to use a computer to control geometric adjustment. Consult your dealer. Up to three geometric adjustments performed using the computer can be saved.

### Setting [KEYSTONE] or [CURVED]

- 1) Press ▲▼ to select [GEOMETRY(2D)].
- 2) Press ◀▶ to select [KEYSTONE] or [CURVED].
- 3) Press the <ENTER> button.
  - The [GEOMETRY:KEYSTONE] or [GEOMETRY:CURVED] screen is displayed.
- 4) Press ▲▼ to select the item to adjust.
- 5) Press ◀▶ to adjust.

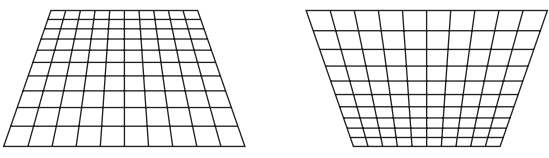
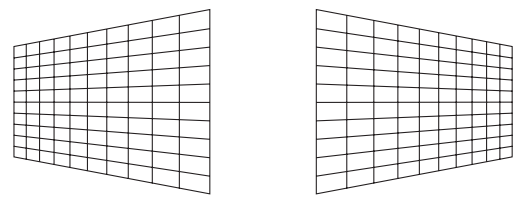
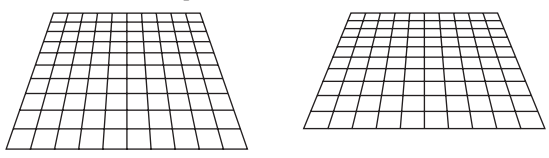
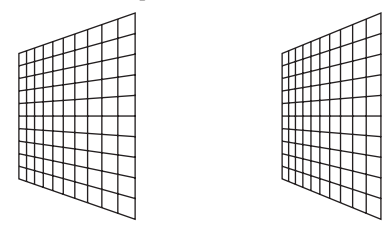
[KEYSTONE]			
<b>[LENS THROW RATIO]</b> Set the throw ratio for the lens used.			
<b>[VERTICAL KEYSTONE]</b> 	<b>[HORIZONTAL KEYSTONE]</b> 		
<b>[VERTICAL BALANCE]</b> 	<b>[HORIZONTAL BALANCE]</b> 		
Adjust the setting according to the lens shift range in the vertical direction.		Adjust the setting according to the lens shift range in the horizontal direction.	

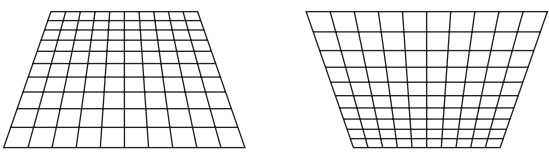
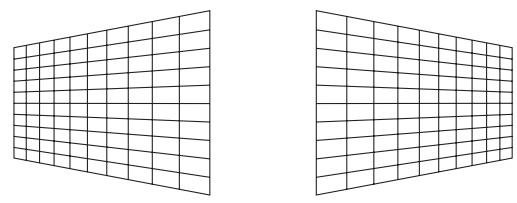
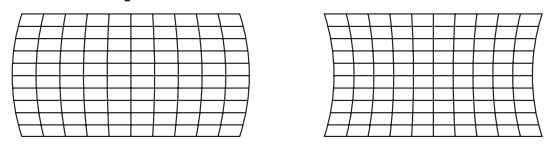
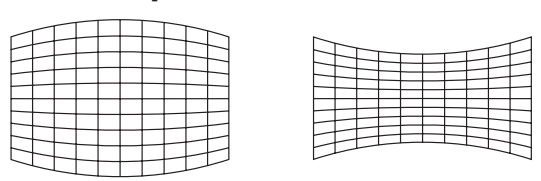
[CURVED]			
<b>[LENS THROW RATIO]</b> Set the throw ratio for the lens used.			
<b>[VERTICAL KEYSTONE]</b> 	<b>[HORIZONTAL KEYSTONE]</b> 		
<b>[VERTICAL ARC]</b> 	<b>[HORIZONTAL ARC]</b> 		

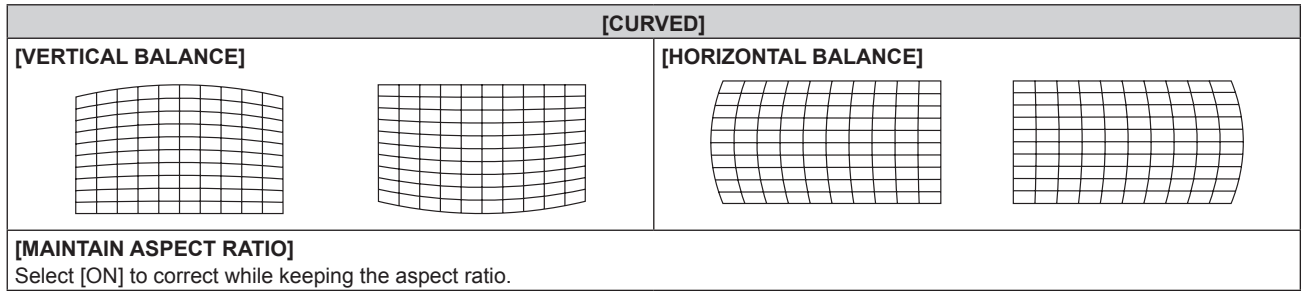

### Setting [CORNER CORRECTION]

- 1) Press ▲▼ to select [GEOMETRY(2D)].
- 2) Press ◀▶ to select [CORNER CORRECTION].
- 3) Press the <ENTER> button.
  - The [GEOMETRY:CORNER CORRECTION] screen is displayed.
- 4) Press ▲▼ to select the item to adjust, and press the <ENTER> button.
- 5) Press ▲▼◀▶ to adjust.

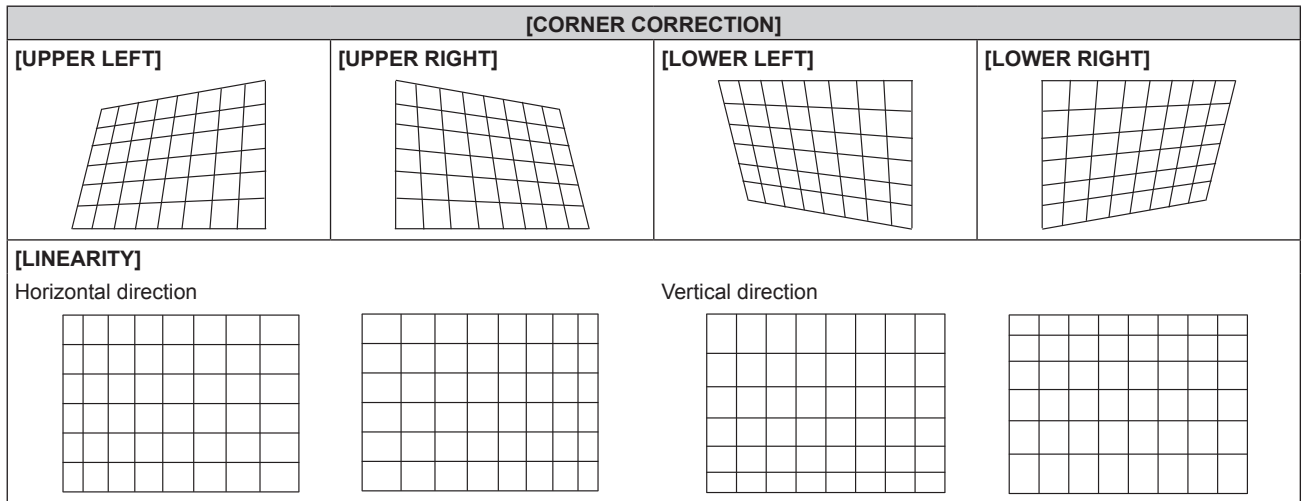

### Note

- The menu or logo may run off the screen when [GEOMETRY(2D)] is set.
- If [EDGE BLENDING] (➔ page 86) adjustment and [GEOMETRY(2D)] are used together, correct edge blending adjustment may not be possible in certain environments.
- The optional Upgrade Kit (Model No.: ET-UK20) can be used to expand the correctable range. To purchase the product, consult your dealer.
- [GEOMETRY(2D)] is selectable only when a 2D image is displayed. The setting is invalid while a 3D image is displayed. When executing the keystone correction while displaying a 3D image, set with [KEystone(3D)].  
However, if [3D SYSTEM SETTING] is set to [DUAL (LEFT)] or [DUAL (RIGHT)], the keystone correction becomes possible by selecting [GEOMETRY(2D)] while a 3D image is displayed.

### [KEYSTONE(3D)]

(Only for PT-DZ870E)

While displaying a 3D image, corrects the keystone distortion that occurs when the projector is installed tilted or when the screen is tilted.

- 1) Press ▲▼ to select [KEYSTONE(3D)].
- 2) Press the <ENTER> button.
  - The [KEYSTONE(3D)] screen is displayed.
- 3) Press ▲▼ to select the item to adjust.
- 4) Press ◀▶ to adjust.

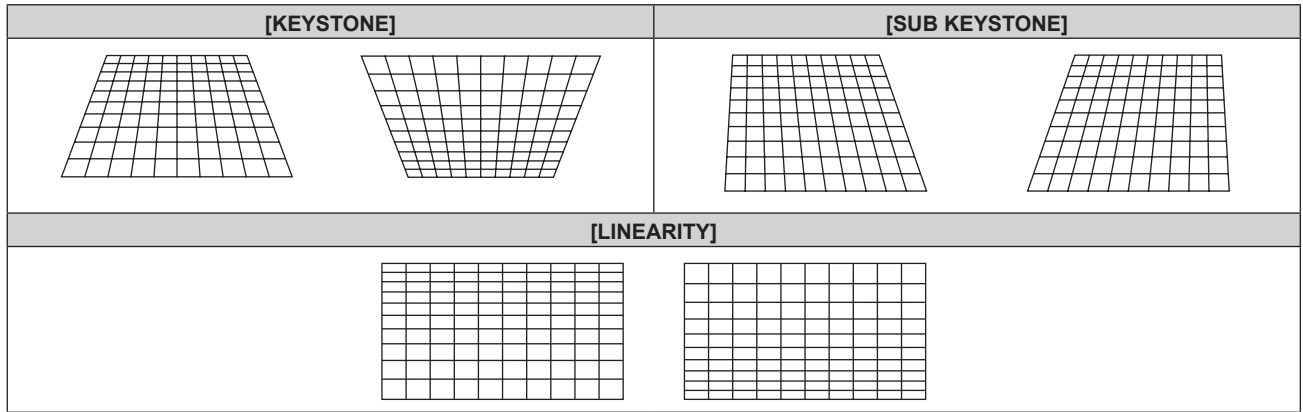

### Note

- The menu or logo may run off the screen when adjustments are performed with [KEYSTONE(3D)].
- Correcting up to  $\pm 40^\circ$  for the tilt in the vertical direction is available in the adjustments with [KEYSTONE(3D)]. However, the image quality will degrade and it will get harder to focus with more correction. Install the projector so that the correction will be as small as possible. (The correction is  $\pm 30^\circ$  when the fixed-focus lens (Model No.: ET-DLE055) or ultra-short focus zoom lens (Model No.: ET-DLE085) is used.)
- Screen size will also change when [KEYSTONE(3D)] is used to perform various adjustments.
- When the keystone is corrected with [KEYSTONE(3D)], the edge blending cannot be adjusted together.
- Aspect ratio of the image size may shift depending on the correction or lens zoom value.
- [KEYSTONE(3D)] is selectable only when a 3D image is displayed. The setting is invalid while a 2D image is displayed. However, when [DUAL (LEFT)] or [DUAL (RIGHT)] is set to [3D SYSTEM SETTING], [KEYSTONE(3D)] cannot be selected.
- When executing the keystone correction while displaying a 2D image, set with [GEOMETRY(2D)].

### [KEYSTONE]

(Only for PT-DW830E, PT-DX100E)

You can correct the keystone distortion that occurs when the projector is installed tilted or when the screen is tilted.

- 1) Press **▲▼** to select [KEYSTONE].
- 2) Press the **<ENTER>** button.
  - The [KEYSTONE] screen is displayed.
- 3) Press **▲▼** to select the item to adjust.
- 4) Press **◀▶** to adjust.

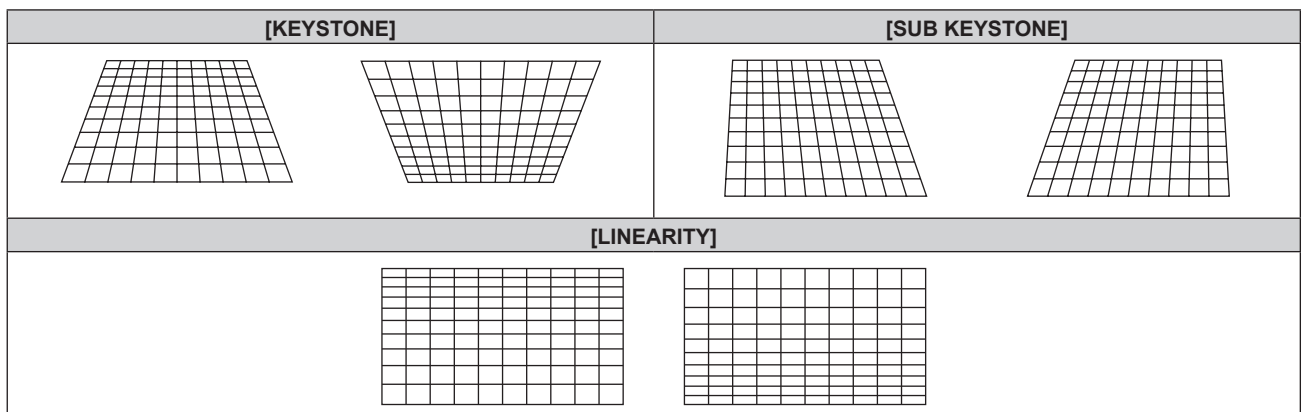

### Note

- The menu or logo may run off the screen when adjustments are performed with [KEYSTONE].
- Correcting up to  $\pm 40^\circ$  for the tilt in the vertical direction is available for adjustments with [KEYSTONE]. However, the image quality will degrade and it will get harder to focus with more correction. Install the projector so that the correction will be as small as possible. (The correction is  $\pm 30^\circ$  when the fixed-focus lens (Model No.: ET-DLE055) or ultra-short focus zoom lens (Model No.: ET-DLE085) is used.)
- Screen size will also change when [KEYSTONE] is used to perform various adjustments.
- When the keystone is corrected with [KEYSTONE], the edge blending cannot be adjusted together.
- Aspect ratio of the image size may shift depending on the correction or lens zoom value.

## [ADVANCED MENU] menu

On the menu screen, select [ADVANCED MENU] from the main menu, and select an item from the sub-menu.

Refer to “Navigating through the menu” (→ page 65) for the operation of the menu screen.

- After selecting the item, press ▲▼◀▶ to adjust.

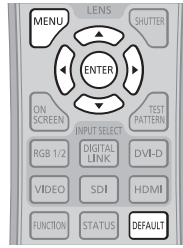

### [DIGITAL CINEMA REALITY]

You can increase the vertical resolution and enhance the image quality by performing cinema processing when the PAL (or SECAM) 576i signal, the NTSC 480i signal, and 1080/50i, 1080/60i are input.

1) Press ▲▼ to select [DIGITAL CINEMA REALITY].

2) Press ◀▶ to switch the item.

- The items will switch each time you press the button.

[AUTO]	Performs automatic detection and cinema processing. (Factory default)	
[OFF]	Does not perform cinema processing.	
[30p FIXED]	Only during 480i or 1080/60i signal input	Performs forced cinema processing (2:2 pulldown).
[25p FIXED]	Only during 576i or 1080/50i signal input	

#### Note

- In [DIGITAL CINEMA REALITY], the picture quality will degrade when a signal other than the 2:2 pulldown is set as [25p FIXED] or [30p FIXED]. (Vertical resolution will degrade.)
- When [FRAME RESPONSE] is set to [FAST], [DIGITAL CINEMA REALITY] cannot be set.

### [BLANKING]

You can adjust the blanking width if there are noises at the edge of the screen or the image is slightly running out from the screen while an image from the VCR or other devices are projected.

1) Press ▲▼ to select [BLANKING].

2) Press the <ENTER> button.

- The [BLANKING] adjustment screen is displayed.

3) Press ▲▼ to select [UPPER], [LOWER], [LEFT], or [RIGHT].

- When [CUSTOM MASKING] is set to an item ([PC-1], [PC-2], or [PC-3]) other than [OFF], the blanking width can be adjusted to any shape using the computer. Up to three blanking settings adjusted using the computer can be saved.  
To use the [CUSTOM MASKING] function, the optional Upgrade Kit (Model No.: ET-UK20) is required. To purchase the product, consult your dealer.

4) Press ◀▶ to adjust the blanking width.

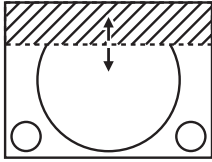
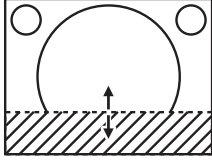
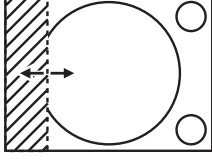
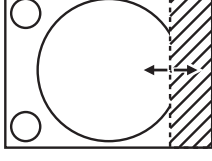

Blanking correction	Item	Operation	Adjustment	Range of adjustment	
Top of the screen	[UPPER]	Press the ◀ button.	The blanking zone moves upward.		PT-DZ870E: Top to bottom 0 - 599 PT-DW830E: Top to bottom 0 - 399 PT-DX100E: Top to bottom 0 - 383
		Press the ▶ button.	The blanking zone moves downward.		
Bottom of the screen	[LOWER]	Press the ▶ button.	The blanking zone moves upward.		
		Press the ◀ button.	The blanking zone moves downward.		
Left side of the screen	[LEFT]	Press the ▶ button.	The blanking zone moves to the right.		
		Press the ◀ button.	The blanking zone moves to the left.		
Right side of the screen	[RIGHT]	Press the ◀ button.	The blanking zone moves to the right.		PT-DZ870E: Left to right 0 - 959 PT-DW830E: Left to right 0 - 639 PT-DX100E: Left to right 0 - 511
		Press the ▶ button.	The blanking zone moves to the left.		

## [INPUT RESOLUTION]

You can adjust to achieve an optimal image when there is a flickering image or smeared outlines.

- 1) Press ▲▼ to select [INPUT RESOLUTION].
- 2) Press the <ENTER> button.
  - The [INPUT RESOLUTION] screen is displayed.
- 3) Press ▲▼ to select [TOTAL DOTS], [DISPLAY DOTS], [TOTAL LINES], or [DISPLAY LINES], and press ◀▶ to adjust each item.
  - Values corresponding to the signal being input are displayed automatically for each item. Increase or decrease the displayed values and adjust to the optimal point viewing the screen when there are vertical stripes or sections are missing from the screen.

### Note

- Previously mentioned vertical banding will not occur with all white signal input.
- The image may be disrupted while performing the adjustment, but it is not a malfunction.
- [INPUT RESOLUTION] can be adjusted only when an RGB signal is input to the <RGB 1 IN> terminal or the <RGB 2 IN> terminal.
- Certain signals may not be adjustable.

## [CLAMP POSITION]

You can adjust the optimal point when the black part of the image is blunt or it has turned green.

- 1) Press ▲▼ to select [CLAMP POSITION].
- 2) Press ◀▶ to adjust.

Status	Rough guide for optimal value	Range of adjustment
The black part is blunt.	The point where bluntness of the black part improves the most is the optimal value.	1 - 255
The black part is green.	The point where the green part becomes black, and the bluntness has improved is the optimal value.	

### Note

- [CLAMP POSITION] can be adjusted only when a signal is input to the <RGB 1 IN> terminal or the <RGB 2 IN> terminal.
- Certain signals may not be adjustable.

**[EDGE BLENDING]**

The edge blending function allows multiple projector images to be seamlessly overlapped by using the inclination of the brightness at the overlapped area.

1) Press ▲▼ to select [EDGE BLENDING].

2) Press ◀▶ to switch the item.

- The items will switch each time you press the button.

[OFF]	Sets the edge blending function to off.
[ON]	Use the setting value of the internal distortion of the set for the inclination of the edge blending area.
[USER]	Use the user-setting value for the inclination of the edge blending area. (Configuration/registration requires separate software. Consult your dealer.)

- To adjust edge blending, proceed to Step 3).

3) When [ON] or [USER] is selected, press the <ENTER> button.

- The [EDGE BLENDING] screen is displayed.

4) Press ▲▼ to specify the location to be corrected.

- When joining at top: Set [UPPER] to [ON]
- When joining at bottom: Set [LOWER] to [ON]
- When joining at left: Set [LEFT] to [ON]
- When joining at right: Set [RIGHT] to [ON]

5) Press ◀▶ to switch between [ON] and [OFF].

6) Press ▲▼ to select [START] or [WIDTH].

7) Press ◀▶ to adjust the starting position or correction width.

8) Press ▲▼ to select [MARKER].

9) Press ◀▶ to switch to [ON].

- A marker for image position adjustment is displayed. The position where the red and green lines overlap for the projectors to be joined will be the optimal point. Make sure to set the correction width for the projectors to be joined with the same value. Optimal joining is not possible with projectors that have different correction widths.

The optimal point is the point at which these lines overlap.

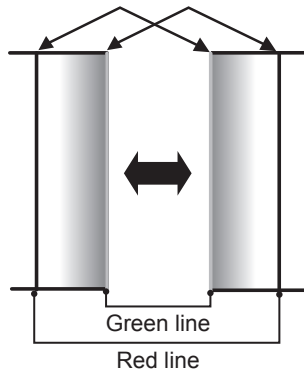

10) Press ▲▼ to select [BRIGHTNESS ADJUST].

11) Press the <ENTER> button.

- The [BRIGHTNESS ADJUST] screen is displayed.
- By setting [AUTO TESTPATTERN] on the [EDGE BLENDING] screen to [ON], the black test pattern is displayed when you enter the [BRIGHTNESS ADJUST] screen.

12) Press ▲▼ to select [NON-OVERLAPPED BLACK LEVEL].

13) Press the <ENTER> button.

- The [NON-OVERLAPPED BLACK LEVEL] screen is displayed.
- If [INTERLOCKED] is set to [OFF], [RED], [GREEN], and [BLUE] can be adjusted individually.

14) Press ▲▼ to select an item, and press ◀▶ to adjust the setting.

- After the adjustment is completed, press the <MENU> button to return to the [BRIGHTNESS ADJUST] screen.

- 15) Press ▲▼ to select [UPPER], [LOWER], [LEFT], or [RIGHT] in [BLACK BORDER WIDTH]
- 16) Press ◀▶ to set the region (width) of the [BLACK BORDER WIDTH] adjustment.
  - When PT-DZ870E is used, proceed to Step 17).
  - When PT-DW830E or PT-DX100E is used, proceed to Step 19).
- 17) Press ▲▼ to select [UPPER KEYSTONE AREA], [LOWER KEYSTONE AREA], [LEFT KEYSTONE AREA], or [RIGHT KEYSTONE AREA].
- 18) Press ◀▶ to adjust the tilt of the border between [NON-OVERLAPPED BLACK LEVEL] and [BLACK BORDER LEVEL].
- 19) Press ▲▼ to select [BLACK BORDER LEVEL].
- 20) Press the <ENTER> button.
  - The [BLACK BORDER LEVEL] screen is displayed.
  - If [INTERLOCKED] is set to [OFF], [RED], [GREEN], and [BLUE] can be adjusted individually.
- 21) Press ▲▼ to select an item, and press ◀▶ to adjust the setting.

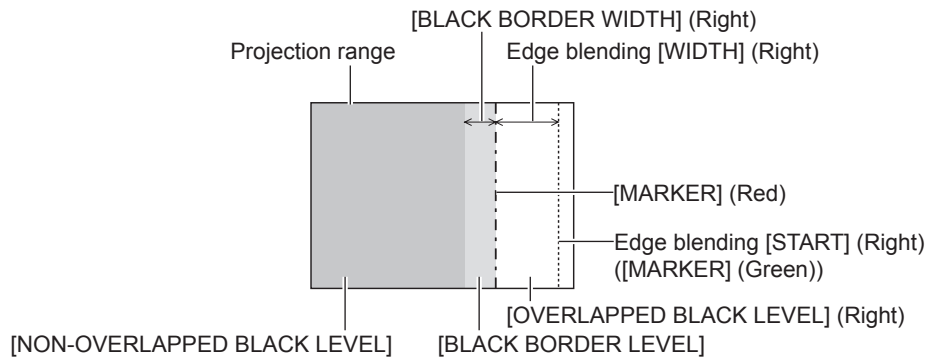

**Note**

- [BRIGHTNESS ADJUST] is a function that makes the increased brightness in black level of the overlapping image area difficult to notice when [EDGE BLENDING] is used to configure multiple screens. The optimal point of correction is set by adjusting [NON-OVERLAPPED BLACK LEVEL] so the black level of the overlapping image area will be the same level as the non-overlapping area. If the border area of the part where the image is overlapping and the non-overlapping part gets brighter after adjusting [NON-OVERLAPPED BLACK LEVEL], adjust the width of the top, bottom, left, or right. Adjust [BLACK BORDER LEVEL] when the width adjustment makes only the border area darker.
- The joining part may look discontinuous depending on the position you are looking from when a screen with high gain or rear screen is used.
- When configuring multiple screens using both horizontal and vertical edge blending, adjust [OVERLAPPED BLACK LEVEL] first before making adjustments in Step 12). Adjustment method is same as the procedure of [NON-OVERLAPPED BLACK LEVEL].
- If only horizontal or vertical edge blending is used, set all items in [OVERLAPPED BLACK LEVEL] to 0.
- [AUTO TESTPATTERN] settings change together with the [AUTO TESTPATTERN] of [COLOR MATCHING].
- Adjustment of the tilt of the border between [NON-OVERLAPPED BLACK LEVEL] and [BLACK BORDER LEVEL] is a function to perform the adjustment of [GEOMETRY(2D)] (▶ page 80) together with the edge blending. If [NON-OVERLAPPED BLACK LEVEL] is tilted by correcting the keystone distortion from [KEystone] in [GEOMETRY(2D)], perform Steps 17)18) to adjust the edge blending according to the shape of [NON-OVERLAPPED BLACK LEVEL].
- When the keystone is corrected with [KEYSTONE(3D)], the edge blending cannot be adjusted together. (Only for PT-DZ870E)
- When the keystone is corrected with [KEYSTONE], the edge blending cannot be adjusted together. (Only for PT-DW830E, PT-DX100E)

**[FRAME RESPONSE]**

Set image frame delay.

- 1) Press ▲▼ to select [FRAME RESPONSE].
- 2) Press ◀▶ to switch the item.
  - The items will switch each time you press the button.

[NORMAL]	Standard setting.
[FAST]*1	Simplifies the image processing to reduce image frame delay.
[FIXED]*2	Sets image frame delay to be constant regardless of the image position or magnification.

\*1 When input signals are other than interlaced signals, [FAST] cannot be set.

\*2 Only when movie-based signals and still image signals with the vertical scanning frequency of 50 Hz or 60 Hz are input

**Note**

- When [FRAME RESPONSE] is set to [FAST], picture quality deteriorates. Also, [DIGITAL CINEMA REALITY] cannot be set.
- [FRAME RESPONSE] cannot be set during P IN P.

## [FRAME LOCK]

Set this to view 3D display when the vertical scanning frequency of the signal is 25 Hz, 50 Hz, and 100 Hz.

1) Press ▲▼ to select [FRAME LOCK].

2) Press ◀▶ to switch the item.

- The items will switch each time you press the button.

[OFF]	Decreases the flickering of the display.
[ON]	Synchronizes the display to the vertical scanning frequency of the input signal.

### Note

- [FRAME LOCK] is not displayed when the vertical scanning frequency of a signal other than the above is input or 2D images are displayed.
- The screen may flicker when [FRAME LOCK] is set to [ON].
- The display may look discontinuous when [FRAME LOCK] is set to [OFF].

## [RASTER POSITION]

This will allow the position of the image to move within the display area arbitrarily when the input image is not using the whole display area.

1) Press ▲▼ to select [RASTER POSITION].

2) Press the <ENTER> button.

- The [RASTER POSITION] screen is displayed.

3) Press ▲▼◀▶ to adjust the position.

## [DISPLAY LANGUAGE] menu

On the menu screen, select [DISPLAY LANGUAGE] from the main menu, and display the sub-menu.

Refer to “Navigating through the menu” (➔ page 65) for the operation of the menu screen.

- Press ▲▼ to select a language, and press the <ENTER> button to set.

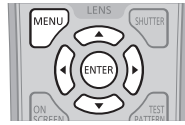

### Changing the display language

You can select the language of the on-screen display.

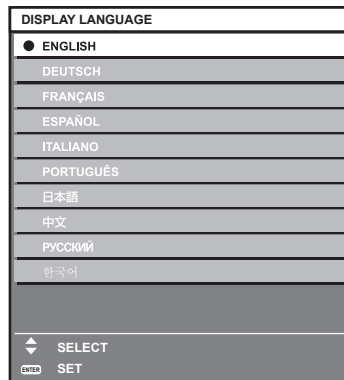

- Various menus, settings, adjustment screens, control button names, etc., are displayed in the selected language.
- The language can be changed to English, German, French, Spanish, Italian, Portuguese, Japanese, Chinese, Russian, or Korean.

#### Note

- The on-screen display language of the projector is set to English by default and when [ALL USER DATA] (➔ page 123) in [INITIALIZE] is executed.

## [3D SETTINGS] menu

On the menu screen, select [3D SETTINGS] from the main menu, and select an item from the sub-menu.

Refer to “Navigating through the menu” (➔ page 65) for the operation of the menu screen.

- After selecting the item, press ▲▼◀▶ to set.



### [3D SYSTEM SETTING]

Set a picture display method for use during 3D signal input as necessary for the 3D system in use.

1) Press ▲▼ to select [3D SYSTEM SETTING].

2) Press ◀▶ to switch the item.

- The items will switch each time you press the button.

[SINGLE]	During 3D signal input, images for the right eye and images for the left eye are alternately displayed with the frame sequential system.
[DUAL (LEFT)]	Only images for the left eye are displayed during 3D signal input.
[DUAL (RIGHT)]	Only images for the right eye are displayed during 3D signal input.

#### Note

- When 2D images are input, 2D images are displayed regardless of [3D SYSTEM SETTING] settings.

### [DLP Link]

You can set this function when using the 3D eyewear that supports DLP Link.

1) Press ▲▼ to select [DLP Link].

2) Press ◀▶ to switch the item.

- The items will switch each time you press the button.

[ON]	Enables the DLP Link function.
[OFF]	Disables the DLP Link function.

#### Note

- If [DLP Link] is set to [ON], [DYNAMIC IRIS] is fixed to [OFF] while 3D images are displayed.

### [3D SYNC SETTING]

Set the way in which the <3D SYNC 1 IN/OUT> terminal and the <3D SYNC 2 OUT> terminal will be used.

#### Attention

- Before connecting external devices to the <3D SYNC 1 IN/OUT> terminal and the <3D SYNC 2 OUT> terminal using cables, complete the [3D SYNC MODE] setting and confirm that the external devices to be connected are turned off.
- Changing [3D SYNC MODE] while the cables are connected may result in malfunctions of the projector or the connected external devices.

1) Press ▲▼ to select [3D SYNC SETTING].

2) Press the <ENTER> button.

- The precaution message related to [3D SYNC SETTING] is displayed.

3) Press the <ENTER> button.

- The [3D SYNC SETTING] screen is displayed.

4) Press ▲▼ to select [3D SYNC MODE].

5) Press ◀▶ to switch the item.

[3D SYNC MODE]	Items set in [3D SYNC1]	Items set in [3D SYNC2]
[OFF]	Not used.	Not used.
[1]	3D trigger output	Stereo synch output
[2]	3D trigger output	3D trigger output
[3]	Stereo synch input	Through 3D SYNC1
[4]	Stereo synch input	Stereo synch output
[5]	Stereo synch input	3D trigger output
[6]	Frame synch input	Through 3D SYNC1
[7]	Frame synch input	Stereo synch output
[8]	Frame synch input	3D trigger output
[9]	3D trigger output	Frame synch output
[10]	Stereo synch output	Frame synch output
[11]	3D IR TRANSMITTER (+) output	3D IR TRANSMITTER (-) output

6) When [1], [4], [7], or [10] is selected, press ▲▼ to select [STEREO SYNC OUTPUT DELAY], and press ◀▶ to set the amount of delay output.

[0us] - [25000us]	Allows you to set in increments of 10 us.
-------------------	---

- To synchronize multiple projectors to display 3D images, use a frame synch input and output.  
Select [9] or [10] for the first projector.  
Select [6], [7], or [8] for the second and subsequent projectors.
- Stereo synchronization is a signal having a 50 % duty cycle where High is for the left eye and Low is for the right eye.
- “H” is output to the 3D image display and “L” is output to the 2D image display from the terminal for which 3D trigger output is selected.

#### Note

- [11] or [3D SYNC MODE] is the setting when the 3D IR transmitter TY-3DTRW of Panasonic is used with the projector. Consult your dealer regarding the connection method.

### [3D SIMUL INPUT SETTING]

Set this item to input and use 3D video signals of the simultaneous system.

- 1) Press ▲▼ to select [3D SIMUL INPUT SETTING].
- 2) Press the <ENTER> button.
  - The [3D SIMUL INPUT SETTING] screen is displayed.
- 3) Press ▲▼ to select [LEFT:RGB1 RIGHT:RGB2] or [LEFT:HDMI RIGHT:DVI-D].
- 4) Press ◀▶ to switch the setting.

[OFF]	Does not display 3D images of the simultaneous system.
[AUTO]	Displays 3D images of the simultaneous system.

#### Note

- When set to [AUTO], 3D images are displayed when the same 3D compatible signals are entered to each input. However, the P IN P status during P IN P is maintained.
- This may not function properly for some connected external devices.
- Certain signals may not function properly.

### [3D INPUT FORMAT]

Set the 3D format for the image signals being input.

Set a 3D format that matches the input signal.

- 1) Press ▲▼ to select [3D INPUT FORMAT].
- 2) Press the <ENTER> button.
  - The [3D INPUT FORMAT] screen is displayed.
- 3) Press ▲▼ to select a 3D format.

[AUTO]*1	Automatically detects 3D format of input image signals and displays images.
----------	---

[NATIVE]	Forcibly displays 2D images regardless of input image signals.
[SIMULTANEOUS] <sup>*2</sup>	Forcibly displays 3D images in simultaneous system regardless of input video signals.
[SIDE BY SIDE]	Forcibly displays 3D images in side by side format regardless of input image signals.
[TOP AND BOTTOM]	Forcibly displays 3D images in top and bottom format regardless of input image signals.
[LINE BY LINE] <sup>*3</sup>	Forcibly displays 3D images in line by line system regardless of input video signals.
[FRAME SEQUENTIAL] <sup>*4</sup>	Forcibly displays 3D images in frame sequential format regardless of input image signals.

\*1 During DVI-D, HDMI, or DIGITAL LINK input only

\*2 During 3G-SDI level B input only

\*3 Only while signals other than interlaced signals are input

\*4 Only while progressive signals with the vertical scanning frequency of 100 Hz or 120 Hz are input to the <RGB1>/<RGB2>/<DVI-D> terminals

#### 4) Press the <ENTER> button.

#### Note

- When set to [AUTO], [SIMULTANEOUS], [SIDE BY SIDE], [TOP AND BOTTOM], [LINE BY LINE], or [FRAME SEQUENTIAL], 3D images are not displayed in [3D SIMUL INPUT SETTING]. In [AUTO], however, this only occurs when 3D format can be recognized.
- This may not function properly for some connected external devices.

### [3D 24Hz IMAGE PROJECTION]

(Only for PT-DZ870E)

Set the output frame rate when a 3D signal with the vertical scanning frequency of 24 Hz is input.

#### 1) Press ▲▼ to select [3D 24Hz IMAGE PROJECTION].

#### 2) Press ◀▶ to switch the item.

- The items will switch each time you press the button.

[144fps]	Displays images with the frame rate of 144 fps.
[96fps]	Displays images with the frame rate of 96 fps.

#### Note

- This function is enabled only when a 3D signal with the vertical scanning frequency of 24 Hz is input. The [3D 24Hz IMAGE PROJECTION] setting can be changed even when the corresponding signal is not input.
- When [3D 24Hz IMAGE PROJECTION] is set to [144fps], [SCREEN SETTING] (➔ page 96) cannot be selected. [SCREEN FORMAT] is fixed to [16:9] and [SCREEN POSITION] cannot be adjusted. Adjust the image position using [3D 24Hz IMAGE POSITION].
- When [3D 24Hz IMAGE PROJECTION] is set to [144fps], the image may not be displayed correctly if the function of [CUSTOM MASKING] (➔ page 84), [EDGE BLENDING] (➔ page 86), [UNIFORMITY] (➔ page 103), or [DISPLAY SETTING] (➔ page 131) is used.

### [3D 24Hz IMAGE POSITION]

(Only for PT-DZ870E)

Set the image position when a 3D signal with the vertical scanning frequency of 24 Hz is input.

#### 1) Press ▲▼ to select [3D 24Hz IMAGE POSITION].

#### 2) Press ◀▶ to adjust the position.

- Adjust the vertical position between -60 and +60.

#### Note

- The position can be adjusted only when [3D 24Hz IMAGE PROJECTION] is set to [144fps] and a 3D signal with the vertical scanning frequency of 24 Hz is input.

### [LEFT/RIGHT SWAP]

Display images by inverting the timing of horizontal image switching. Change the settings when there is something wrong with the 3D image being viewed.

#### 1) Press ▲▼ to select [LEFT/RIGHT SWAP].

#### 2) Press ◀▶ to switch the item.

- The items will switch each time you press the button.

[NORMAL]	Do not change the [NORMAL] setting if the 3D images are displayed correctly.
[SWAPPED]	Select this when left and right 3D images are swapped to be displayed.



**Note**

- This is disabled when [3D SYSTEM SETTING] is set to other than [SINGLE].

**[SUB CLOCK PHASE]**

You can adjust the image when the image flickers or outline blurs.

- 1) Press ▲▼ to select [SUB CLOCK PHASE].
- 2) Press ◀▶ or the <ENTER> button.
  - The [SUB CLOCK PHASE] individual adjustment screen is displayed.
- 3) Press ◀▶ to adjust.
  - Adjustment value will change between [0] and [+31]. Adjust so that the amount of interference is at a minimum.

**Note**

- Enables during simultaneous system 3D video signal input to RGB1 and RGB2 and adjusts the images for the right eye.
- This is disabled when [3D SYSTEM SETTING] is set to other than [SINGLE].
- This is disabled when [3D TEST PATTERN] is displayed.
- This is disabled when [3D TEST MODE] is set to other than [NORMAL].

**[3D FRAME DELAY]**

Adjust the timing of the left-right switch of an image.

- 1) Press ▲▼ to select [3D FRAME DELAY].
- 2) Press ◀▶ to switch the item.

[0us] - [25000us]	Allows you to set in increments of 10 us.
-------------------	---

- The adjustment range depends on the input signal.

**[3D TEST MODE]**

Set the image display system for use with 3D system adjustments.

- 1) Press ▲▼ to select [3D TEST MODE].
- 2) Press ◀▶ to switch the item.

[NORMAL]	Standard setting.
[LEFT/LEFT]	Both the left eye image and right eye image display the left eye input signal.
[RIGHT/RIGHT]	Both the left eye image and right eye image display the right eye input signal.
[LEFT/BLACK]	The left eye input signal is displayed in the left eye image and a completely black image is displayed in the right eye image.
[BLACK/RIGHT]	A completely black image is displayed in the left eye image and the right input signal is displayed in the right eye image.

**Note**

- The [3D TEST MODE] settings return to [NORMAL] when the projector is switched off.
- This is disabled when [3D SYSTEM SETTING] is set to other than [SINGLE].
- This is disabled when [3D TEST PATTERN] is displayed.

**[3D TEST PATTERN]**

The 3D test pattern can be used to check operation and make adjustments even without a 3D signal.

- 1) Press ▲▼ to select [3D TEST PATTERN].
- 2) Press ◀▶ to switch [3D TEST PATTERN].
  - Select a test pattern so that it is easy to check operations and make adjustments.

**Note**

- The 3D test pattern cannot be displayed when the following inputs are selected.
  - VIDEO input
  - RGB1 input (only when [RGB IN] is set to [Y/C])
- This is disabled when [3D SYSTEM SETTING] is set to other than [SINGLE].

- Displays the 3D test pattern in 60 Hz vertical scanning frequency when no signal is input. When a signal is input, the 3D test pattern is displayed in the vertical scanning frequency that is same as the input signal.

## [SAFETY PRECAUTIONS MESSAGE]

Set to show or hide the safety precautions message related to 3D viewing when the projector is switched on.

1) Press ▲▼ to select [SAFETY PRECAUTIONS MESSAGE].

2) Press ◀▶ to switch the item.

- The items will switch each time you press the button.

[ON]	Shows the safety precautions message related to 3D viewing when the projector is switched on.
[OFF]	Hides the safety precautions message related to 3D viewing when the projector is switched on.

### Note

- Set to [OFF] to hide the safety precautions message related to 3D viewing when the projector is switched on.
- A confirmation screen is displayed when switched from [ON] to [OFF]. Press ◀▶ to select [OK], and press the <ENTER> button to change the setting to [OFF].

### Attention

- When 3D images are viewed by unspecified number of people for commercial use, display the safety precautions message related to 3D viewing to notify viewers.

## [3D SAFETY PRECAUTIONS]

Show the safety precautions message related to 3D viewing.

1) Press ▲▼ to select [3D SAFETY PRECAUTIONS].

2) Press the <ENTER> button.

- The [3D SAFETY PRECAUTIONS] screen is displayed.
- Press ◀▶ to switch the page.

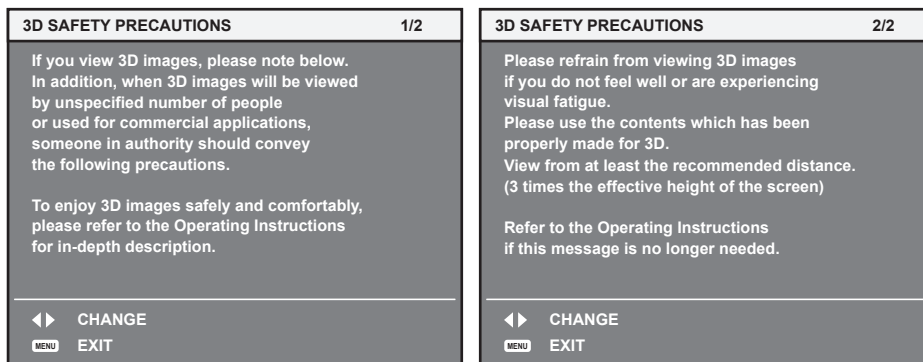

## [DISPLAY OPTION] menu

On the menu screen, select [DISPLAY OPTION] from the main menu, and select an item from the sub-menu.

Refer to “Navigating through the menu” (➔ page 65) for the operation of the menu screen.

- After selecting the item, press ▲▼◀▶ to set.



### [COLOR MATCHING]

Correct the color difference between projectors when using multiple projectors simultaneously.

#### Adjusting the color matching as desired

1) Press ▲▼ to select [COLOR MATCHING].

2) Press ◀▶ to switch the item.

- The items will switch each time you press the button.

[OFF]	Color matching adjustment is not carried out.
[3COLORS]	Adjusts the three colors [RED], [GREEN], or [BLUE].
[7COLORS]	Adjusts the seven colors [RED], [GREEN], [BLUE], [CYAN], [MAGENTA], [YELLOW], or [WHITE].
[MEASURED]	Refer to “Adjusting the color matching using a colorimeter” (➔ page 95) for details about this mode.

3) Select [3COLORS] or [7COLORS], and press the <ENTER> button.

- The [3COLORS] or [7COLORS] screen is displayed.

4) Press ▲▼ to select [RED], [GREEN], or [BLUE] ([RED], [GREEN], [BLUE], [CYAN], [MAGENTA], [YELLOW], or [WHITE] for [7COLORS]).

5) Press the <ENTER> button.

- The [3COLORS:RED], [3COLORS:GREEN], or [3COLORS:BLUE] screen is displayed.  
For [7COLORS], the [7COLORS:RED], [7COLORS:GREEN], [7COLORS:BLUE], [7COLORS:CYAN], [7COLORS:MAGENTA], [7COLORS:YELLOW], or [7COLORS:WHITE] screen is displayed.
- Set [AUTO TESTPATTERN] to [ON] to display a test pattern of selected colors.

6) Press ▲▼ to select [RED], [GREEN], or [BLUE].

7) Press ◀▶ to adjust.

- The adjustment value changes between 0\*1 and 2 048.

\*1 The lower limit varies depending on the adjusting color.

#### Note

- Operation when correcting the adjustment color  
When the correction color same as the adjustment color is changed: The luminance of the adjustment color changes.  
When correction color red is changed: Red is added to or subtracted from the adjustment color.  
When correction color green is changed: Green is added to or subtracted from the adjustment color.  
When correction color blue is changed: Blue is added to or subtracted from the adjustment color.
- This adjustment should be carried out by a person who is familiar with the projector or by a service person because a high level of skill is required to make a successful adjustment.
- Pressing the <DEFAULT> button on the remote control will restore the factory default settings for all items.
- If [COLOR MATCHING] is set to other than [OFF], [COLOR CORRECTION] is fixed to [OFF], and [COLOR TEMPERATURE] is fixed to [USER1]. (However, [WHITE BALANCE HIGH] cannot be adjusted.)

#### Adjusting the color matching using a colorimeter

Use a colorimeter that can measure chromaticity coordinates and luminance to change the colors [RED], [GREEN], [BLUE], [CYAN], [MAGENTA], [YELLOW], or [WHITE] to desired colors.

- 1) Press ▲▼ to select [COLOR MATCHING].
- 2) Press ◀▶ to select [MEASURED].
- 3) Press the <ENTER> button.
  - The [MEASURED MODE] screen is displayed.
- 4) Press ▲▼ to select [MEASURED DATA].
- 5) Press the <ENTER> button.
  - The [MEASURED DATA] screen is displayed.
- 6) Measure the current luminance (Y) and the chromaticity coordinates (x, y) using the colorimeter.
- 7) Press ▲▼ to select a color, and press ◀▶ to adjust the setting.
  - Set [AUTO TESTPATTERN] to [ON] to display a test pattern of selected colors.
- 8) Once all the input is completed, press the <MENU> button.
  - The [MEASURED MODE] screen is displayed.
- 9) Press ▲▼ to select [TARGET DATA].
- 10) Press the <ENTER> button.
  - The [TARGET DATA] screen is displayed.
- 11) Press ▲▼ to select a color and press ◀▶ to input coordinates for desired colors.
  - Set [AUTO TESTPATTERN] to [ON] to display a test pattern of selected colors.
- 12) Once all the input is completed, press the <MENU> button.

#### Note

- Colors are not displayed properly when target data is a color outside the region of this projector.
- Set the [AUTO TESTPATTERN] to [ON] to automatically display a test pattern for use in adjusting the selected adjustment colors.
- When using a colorimeter or similar instrument to measure measurement data, measure the colors displayed with [AUTO TESTPATTERN].
- A difference in the color coordinates of target data and measurement values obtained from an instrument may occur for certain instruments and measurement environments used.

### [COLOR CORRECTION]

Colors can be adjusted and registered for each input signal format.

- 1) Press ▲▼ to select [COLOR CORRECTION].
- 2) Press ◀▶ to switch the item.
  - The items will switch each time you press the button.

[OFF]	Standard setting
[USER]	For each of the following four signal formats: VIDEO, Y/C, RGB, and YC <sub>B</sub> C <sub>R</sub> /YP <sub>B</sub> P <sub>R</sub> , six colors of red, green, blue, cyan, magenta, and yellow can be adjusted and registered. Press the <ENTER> button to set the details. Adjustment is possible within the range of -31 - +31.

### [SCREEN SETTING]

Set the screen size.

When changing the aspect of a projected image, correct to the optimum image position for the set screen. Set as necessary for the screen in use.

- 1) Press ▲▼ to select [SCREEN SETTING].
- 2) Press the <ENTER> button.
  - The [SCREEN SETTING] screen is displayed.
- 3) Press ◀▶ to switch the [SCREEN FORMAT] item.
  - The items will switch each time you press the button.

Model No.	[SCREEN FORMAT]	Range when [SCREEN POSITION] is selected
PT-DZ870E	[16:10]	Cannot be adjusted.
	[4:3]	Adjusts the horizontal position between -160 and 160.
	[16:9]	Adjusts the vertical position between -60 and 60.

Model No.	[SCREEN FORMAT]	Range when [SCREEN POSITION] is selected
PT-DW830E	[16:10]	Cannot be adjusted.
	[16:9]	Adjusts the vertical position between -40 and 40.
PT-DX100E	[4:3]	Cannot be adjusted.
	[16:9]	Adjusts the vertical position between -96 and 96.

4) Press ▲▼ to select [SCREEN POSITION].

- If [SCREEN FORMAT] is set to [16:10] in PT-DZ870E and PT-DW830E, or [SCREEN FORMAT] is set to [4:3] in PT-DX100E, then selection and adjustment of [SCREEN POSITION] are not available.

5) Press ◀▶ to adjust [SCREEN POSITION].

**Note**

- When [3D 24Hz IMAGE PROJECTION] (▶ page 92) is set to [144fps], [SCREEN SETTING] cannot be selected. [SCREEN FORMAT] is fixed to [16:9].

## [AUTO SIGNAL]

Set whether to execute automatic setup of signals automatically.

The screen display position or signal level can be adjusted automatically without pressing the <AUTO SETUP> button on the remote control on each occasion if you input unregistered signals frequently at meetings, etc.

1) Press ▲▼ to select [AUTO SIGNAL].

2) Press ◀▶ to switch the item.

- The items will switch each time you press the button.

[OFF]	Sets the auto signal function to off.
[ON]	Executes automatic setup automatically when images are changed to unregistered signals during projection.

## [AUTO SETUP]

Set this when adjusting a special signal or horizontally long (such as 16:9) signal.

### Setting with [MODE]

1) Press ▲▼ to select [AUTO SETUP].

2) Press the <ENTER> button.

- The [AUTO SETUP] screen is displayed.

3) Press ▲▼ to select [MODE].

4) Press ◀▶ to switch the item.

- The items will switch each time you press the button.

[DEFAULT]	Standard setting.
[WIDE]	Select when an image aspect is a wide-screen signal, which does not meet the [DEFAULT] settings.
[USER]	Select when receiving a signal with a special horizontal resolution (number of display dots).

- When [DEFAULT] or [WIDE] is selected, proceed to Step 7).
- When [USER] is selected, proceed to Step 5).

5) Press ▲▼ to select [DISPLAY DOTS], and press ◀▶ to adjust [DISPLAY DOTS] to the horizontal resolution of the signal source.

6) Press ▲▼ to select [MODE].

7) Press the <ENTER> button.

- Automatic adjustment is executed. [PROGRESS] is displayed while automatically adjusting. When complete, the system returns to the [AUTO SETUP] screen.

### Adjusting position automatically

1) Press ▲▼ to select [AUTO SETUP].

- 2) Press the <ENTER> button.
  - The [AUTO SETUP] screen is displayed.
- 3) Press ▲▼ to select [POSITION ADJUST].
- 4) Press ◀▶ to switch the item.

[OFF]	Does not perform automatic adjustment.
[ON]	Adjust the screen position and size when automatic setup is executed.

### Adjusting signal level automatically

- 1) Press ▲▼ to select [AUTO SETUP].
- 2) Press the <ENTER> button.
  - The [AUTO SETUP] screen is displayed.
- 3) Press ▲▼ to select [SIGNAL LEVEL ADJUST].
- 4) Press ◀▶ to switch the item.

[OFF]	Does not perform automatic adjustment.
[ON]	Adjusts black level (on-screen menu [BRIGHTNESS]) and white level (on-screen menu [CONTRAST]) when automatic setup is executed.

### Note

- [SIGNAL LEVEL ADJUST] may not function properly unless a still image containing clear blacks and whites is input.

### [RGB IN]

Set to match the signal to input to the <RGB 1 IN> terminal.

### Setting [RGB1 INPUT SETTING]

- 1) Press ▲▼ to select [RGB IN].
- 2) Press the <ENTER> button.
  - The [RGB IN] screen is displayed.
- 3) Press ▲▼ to select [RGB1 INPUT SETTING].
- 4) Press ◀▶ to switch the item.
  - The items will switch each time you press the button.

[RGB/YP <sub>B</sub> P <sub>R</sub> ]	Select when inputting an RGB signal or YC <sub>B</sub> C <sub>R</sub> /YP <sub>B</sub> P <sub>R</sub> signals to the <RGB 1 IN> terminal.
[Y/C]	Select when inputting a luminance signal and color signal to the <RGB 1 IN> terminal.

### Switching the slice level of an input sync signal

- 1) Press ▲▼ to select [RGB IN].
- 2) Press the <ENTER> button.
  - The [RGB IN] screen is displayed.
- 3) Press ▲▼ to select [RGB1 SYNC SLICE LEVEL] or [RGB2 SYNC SLICE LEVEL].
- 4) Press ◀▶ to switch the item.

[LOW]	Sets the slice level to [LOW].
[HIGH]	Sets the slice level to [HIGH].

### [DVI-D IN]

Switch the setting when the external device is connected to the <DVI-D IN> terminal of the projector and the image is not projected correctly.

- 1) Press ▲▼ to select [DVI-D IN].
- 2) Press the <ENTER> button.
  - The [DVI-D IN] screen is displayed.
- 3) Press ▲▼ to select [EDID].
- 4) Press ◀▶ to switch the item.
  - The items will switch each time you press the button.

[EDID3]	Recognizes movie-based video signals and still image signals automatically.
[EDID1]	Select mainly when an external device that outputs movie-based video signals (such as a blu-ray disc player) is connected to the <DVI-D IN> terminal.
[EDID2:PC]	Select mainly when an external device that outputs still image signals (such as a computer) is connected to the <DVI-D IN> terminal.

- 5) Press ▲▼ to select [SIGNAL LEVEL].
- 6) Press ◀▶ to switch the item.
  - The items will switch each time you press the button.

[AUTO]	Automatically sets the signal level.
[0-255:PC]	Select when an external device (such as a computer) is connected via the DVI-D terminal output.
[16-235]	Select when an external device (such as a blu-ray disc player) is connected via the HDMI terminal output using a conversion cable, etc.

#### Note

- The optimal setting varies depending on the output setting of the connected external device. Refer to the operating instructions of the external device regarding the output of the external device.
- The data for Plug and play will change when the setting is changed. Refer to “List of compatible signals” (▶ page 178) for a resolution that supports plug and play.

### [HDMI IN]

Switch the setting when the external device is connected to the <HDMI IN> terminal of the projector and the image is not projected correctly.

- 1) Press ▲▼ to select [HDMI IN].
- 2) Press the <ENTER> button.
  - The [HDMI IN] screen is displayed.
- 3) Press ◀▶ to switch the [SIGNAL LEVEL] item.
  - The items will switch each time you press the button.

[AUTO]	Automatically sets the signal level.
[64-940]	Select when the HDMI terminal of an external device (such as a blu-ray disc player) is connected to the <HDMI IN> terminal.
[0-1023]	Select when the DVI-D terminal output of an external device (such as a computer) is connected to the <HDMI IN> terminal via a conversion cable or similar cable. Select also when the HDMI terminal output of a computer or other device is connected to the <HDMI IN> terminal.

#### Note

- The optimal setting varies depending on the output setting of the connected external device. Refer to the operating instructions of the external device regarding the output of the external device.
- The displayed signal level is assumed when the input is 30 bits.

### [DIGITAL LINK IN]

Set the signal level when DIGITAL LINK input is selected.

- 1) Press ▲▼ to select [DIGITAL LINK IN].
- 2) Press the <ENTER> button.
  - The [DIGITAL LINK IN] screen is displayed.
- 3) Press ◀▶ to switch [SIGNAL LEVEL].
  - The items will switch each time you press the button.

[AUTO]	Automatically sets the signal level.
[64-940]	Select when the HDMI terminal output of an external device (such as a blu-ray disc player) is connected to the <DIGITAL LINK/LAN> terminal via a twisted-pair-cable transmitter.
[0-1023]	Select this when the DVI-D terminal output or HDMI terminal output of an external device (such as a computer) is connected to the <DIGITAL LINK/LAN> terminal via a twisted-pair-cable transmitter.

**Note**

- The optimal setting varies depending on the output setting of the connected external device. Refer to the operating instructions of the external device regarding the output of the external device.

**[SDI IN]**

(Only for PT-DZ870E)

Set to match the signal to input to the <SDI IN> terminal.

**Setting [SIGNAL LEVEL]**

Select the amplitude of the signal to input.

- 1) Press ▲▼ to select [SDI IN].
- 2) Press the <ENTER> button.
  - The [SDI IN] screen is displayed.
- 3) Press ▲▼ to select [SIGNAL LEVEL].
- 4) Press ◀▶ to switch the item.

[64-940]	Normally use this setting.
[4-1019]	Select when gray is displayed as black.

**Setting [BIT DEPTH]**

- 1) Press ▲▼ to select [SDI IN].
- 2) Press the <ENTER> button.
  - The [SDI IN] screen is displayed.
- 3) Press ▲▼ to select [BIT DEPTH].
- 4) Press ◀▶ to switch the item.

[AUTO]	Automatically select 12 bits or 10 bits.
[12-bit]	Fix to 12 bits.
[10-bit]	Fix to 10 bits.

**Setting [3G-SDI MAPPING]**

- 1) Press ▲▼ to select [SDI IN].
- 2) Press the <ENTER> button.
  - The [SDI IN] screen is displayed.
- 3) Press ▲▼ to select [3G-SDI MAPPING].
- 4) Press ◀▶ to switch the item.

[AUTO]	Automatically select level A or level B.
[LEVEL A]	Fix to level A.
[LEVEL B]	Fix to level B.

**Note**

- Does not operate during SD-SDI or HD-SDI input.



**[ON-SCREEN DISPLAY]**

Set the on-screen display.

**Setting [OSD POSITION]**

Set the position of the menu screen (OSD).

- 1) Press ▲▼ to select [ON-SCREEN DISPLAY].
- 2) Press the <ENTER> button.
  - The [ON-SCREEN DISPLAY] screen is displayed.
- 3) Press ▲▼ to select [OSD POSITION].
- 4) Press ◀▶ to switch the item.
  - The items will switch each time you press the button.

[2]	Sets to the center left of the screen.
[3]	Sets to the bottom left of the screen.
[4]	Sets to the top center of the screen.
[5]	Sets to the center of the screen.
[6]	Sets to the bottom center of the screen.
[7]	Sets to the upper right of the screen.
[8]	Sets to the center right of the screen.
[9]	Sets to the bottom right of the screen.
[1]	Sets to the upper left of the screen.

**Setting [OSD DESIGN]**

Set the color of the menu screen (OSD).

- 1) Press ▲▼ to select [ON-SCREEN DISPLAY].
- 2) Press the <ENTER> button.
  - The [ON-SCREEN DISPLAY] screen is displayed.
- 3) Press ▲▼ to select [OSD DESIGN].
- 4) Press ◀▶ to switch the item.
  - The items will switch each time you press the button.

[1]	Sets to yellow.
[2]	Sets to blue.
[3]	Sets to white.
[4]	Sets to green.
[5]	Sets to peach.
[6]	Sets to brown.

**Setting [OSD MEMORY]**

Set hold for the position of the menu screen (OSD) cursor.

- 1) Press ▲▼ to select [ON-SCREEN DISPLAY].
- 2) Press the <ENTER> button.
  - The [ON-SCREEN DISPLAY] screen is displayed.
- 3) Press ▲▼ to select [OSD MEMORY].
- 4) Press ◀▶ to switch the item.
  - The items will switch each time you press the button.

[ON]	Holds the cursor position.
[OFF]	Does not hold the cursor position.

**Note**

- Even if [OSD MEMORY] is set to [ON], the cursor position will not be held when the <MAIN POWER> switch of the projector body is turned <OFF>.

**Setting [INPUT GUIDE]**

Set whether to display the input guide (input terminal name, signal name, and memory number currently selected) in the position set in the [OSD POSITION].

- 1) Press ▲▼ to select [ON-SCREEN DISPLAY].
- 2) Press the <ENTER> button.
  - The [ON-SCREEN DISPLAY] screen is displayed.
- 3) Press ▲▼ to select [INPUT GUIDE].
- 4) Press ◀▶ to switch the item.
  - The items will switch each time you press the button.

[ON]	Displays the input guide.
[OFF]	Hides the input guide.

**Setting [WARNING MESSAGE]**

Set the display/hide of the warning message.

- 1) Press ▲▼ to select [ON-SCREEN DISPLAY].
- 2) Press the <ENTER> button.
  - The [ON-SCREEN DISPLAY] screen is displayed.
- 3) Press ▲▼ to select [WARNING MESSAGE].
- 4) Press ◀▶ to switch the item.
  - The items will switch each time you press the button.

[ON]	Displays the warning message.
[OFF]	Hides the warning message.

**[CLOSED CAPTION SETTING] (NTSC or 480i YC<sub>B</sub>C<sub>R</sub> signal input only)**

Set closed captions.

**Selecting the closed caption display**

- 1) Press ▲▼ to select [CLOSED CAPTION SETTING].
- 2) Press the <ENTER> button.
  - The [CLOSED CAPTION SETTING] screen is displayed.
- 3) Press ▲▼ to select [CLOSED CAPTION].
- 4) Press ◀▶ to switch the item.
  - The items will switch each time you press the button.

[OFF]	Hides closed captions.
[ON]	Displays closed captions.

- When [ON] is selected, proceed to Step 5).

- 5) When the confirmation screen is displayed, press ◀▶ to select [OK], and press the <ENTER> button.

**Setting the closed caption display**

- 1) Press ▲▼ to select [CLOSED CAPTION SETTING].

- 2) Press the <ENTER> button.
  - The [CLOSED CAPTION SETTING] screen is displayed.
- 3) Press ▲▼ to select [MODE].
- 4) Press ◀▶ to switch the item.
  - The items will switch each time you press the button.

[CC1]	Displays CC1 data.
[CC2]	Displays CC2 data.
[CC3]	Displays CC3 data.
[CC4]	Displays CC4 data.

### Note

- Closed caption is a function that displays text information of video signals mainly used in North America. Captions may not be displayed depending on the connected devices or contents being played back.
- [CLOSED CAPTION SETTING] can be selected only if NTSC or 480i YC<sub>B</sub>C<sub>R</sub> signal is input.
- If [CLOSED CAPTION] is set to [ON], brightness of images may change depending on the external devices compatible with closed caption function to be connected or contents to be used.
- If a closed caption signal of the selected mode is input, the security message set in the [SECURITY] menu → [DISPLAY SETTING] (➔ page 131) is not displayed.
- Closed captions are not displayed when the menu screen is displayed.
- When the correction of [KEYSTONE] is large, all characters may not be displayed. (Only for PT-DW830E, PT-DX100E)

## [BACK COLOR]

Set the display of the projected screen when there is no signal input.

- 1) Press ▲▼ to select [BACK COLOR].
- 2) Press ◀▶ to switch [BACK COLOR].
  - The items will switch each time you press the button.

[BLUE]	Displays the entire projection area in blue.
[BLACK]	Displays the entire projection area in black.
[DEFAULT LOGO]	Displays the Panasonic logo.
[USER LOGO]	Displays the image registered by the user.

### Note

- To create/register the [USER LOGO] image, use "Logo Transfer Software" included in the supplied CD-ROM.

## [STARTUP LOGO]

Set the logo display when the power is turned on.

- 1) Press ▲▼ to select [STARTUP LOGO].
- 2) Press ◀▶ to switch the item.
  - The items will switch each time you press the button.

[DEFAULT LOGO]	Displays the Panasonic logo.
[USER LOGO]	Displays the image registered by the user.
[NONE]	Disables the startup logo display.

### Note

- The startup logo will disappear in approximately 15 seconds.
- To create/register the [USER LOGO] image, use "Logo Transfer Software" included in the supplied CD-ROM.

## [UNIFORMITY]

Correct the brightness and color unevenness of the entire screen.

### Setting each color

- 1) Press ▲▼ to select [UNIFORMITY].

- 2) Press the <ENTER> button.
  - The [UNIFORMITY] screen is displayed.
- 3) Press ▲▼ to select [VERTICAL] or [HORIZONTAL].
- 4) Press ◀▶ to adjust the level.

Parameter	Operation	Adjustment	Range of adjustment
[VERTICAL]	Press the ▶ button.	The lower-side brightness decreases, or the upper-side brightness increases.	-127 - 127
	Press the ◀ button.	The upper-side brightness decreases, or the lower-side brightness increases.	
[HORIZONTAL]	Press the ▶ button.	The right-side brightness decreases, or the left-side brightness increases.	
	Press the ◀ button.	The left-side brightness decreases, or the right-side brightness increases.	

### Setting [PC CORRECTION]

To use the [PC CORRECTION] function, the optional Upgrade Kit (Model No.: ET-UK20) is required. To purchase the product, consult your dealer.

- 1) Press ▲▼ to select [UNIFORMITY].
- 2) Press the <ENTER> button.
  - The [UNIFORMITY] screen is displayed.
- 3) Press ▲▼ to select [PC CORRECTION].
- 4) Press ◀▶ to switch the item.

[OFF]	Does not use a computer to correct.
[ON]*1	Use a computer to correct the brightness and color unevenness of the entire screen.

\*1 Advanced skills are necessary to use computer controls to correct. Consult your dealer.

### Note

- [UNIFORMITY] can be set for each [LAMP SELECT] setting.
- The [UNIFORMITY] settings are not reset to the factory default when [INITIALIZE] is executed.

### [SHUTTER SETTING]

Set image fade-in and fade-out at opening and closing of the shutter. Set automatic opening and closing of the shutter when power is turned on/off.

### Setting [FADE-IN] or [FADE-OUT]

- 1) Press ▲▼ to select [SHUTTER SETTING].
- 2) Press the <ENTER> button.
  - The [SHUTTER SETTING] screen is displayed.
- 3) Press ▲▼ to select [FADE-IN] or [FADE-OUT].
- 4) Press ◀▶ to switch the item.

Item	Adjustment	
[FADE-IN] [FADE-OUT]	[OFF]	Does not set fade-in or fade-out.
	[0.5s] - [10.0s]	Allows you to set the fade-in or fade-out time. Item can be selected from [0.5s] - [4.0s], [5.0s], [7.0s], or [10.0s]. For [0.5s] - [4.0s], selection is possible in increments of 0.5.

### Note

- Press the <SHUTTER> button on the remote control or the control panel during fade-in or fade-out to cancel the fade operation.

## Setting [STARTUP]

- 1) Press ▲▼ to select [SHUTTER SETTING].
- 2) Press the <ENTER> button.
  - The [SHUTTER SETTING] screen is displayed.
- 3) Press ▲▼ to select [STARTUP].
- 4) Press ◀▶ to switch the item.

[OPEN]	Projection begins with the shutter open when the power is turned on.
[CLOSE]	Projection begins with the shutter close when the power is turned on.

## Setting [SHUT-OFF]

- 1) Press ▲▼ to select [SHUTTER SETTING].
- 2) Press the <ENTER> button.
  - The [SHUTTER SETTING] screen is displayed.
- 3) Press ▲▼ to select [SHUT-OFF].
- 4) Press ◀▶ to switch the item.

[KEEP CURRENT STATE]	When the projector is switched off, the projector turns into standby with the shutter status as is.
[OPEN]	When the projector is switched off, the projector turns into standby with the shutter left opened.
[CLOSE]	When the projector is switched off, the projector turns into standby with the shutter left closed.

## [FREEZE]

Pause the projected image temporarily regardless of the playback of the external device.

- 1) Press ▲▼ to select [FREEZE].
- 2) Press the <ENTER> button.
  - Press the <MENU> button to release.

### Note

- [FREEZE] is displayed on the screen when video is paused.

## [WAVEFORM MONITOR]

Use the input signals from a connected external device to display in a waveform. Check whether video output (luminance) signal level is within the recommended range for the projector and adjust.

- 1) Press ▲▼ to select [WAVEFORM MONITOR].
- 2) Press ◀▶ to switch the item.

[OFF]	Does not display the waveform monitor.
[ON]	Displays the waveform monitor.

- 3) Press the <MENU> button two times to clear.
- 4) Press ▲▼ to select any horizontal line.
- 5) Press the <ENTER> button to switch the Select line to either luminance, red, green, or blue.
  - Line selection items switch each time the <ENTER> is pressed only when the waveform monitor is displayed.

“Select line (luminance)”	Displayed in white waveform.
“Select line (red)”	Displayed in red waveform.
“Select line (green)”	Displayed in green waveform.
“Select line (blue)”	Displayed in blue waveform.

**Note**

- Setting is also available from [FUNCTION BUTTON] (➔ page 121).
- Waveform monitor cannot be displayed in [P IN P].
- The waveform monitor turns off when [P IN P] is executed during waveform monitoring.
- The waveform monitor is not displayed when on-screen display is hidden (off).

**Adjusting the waveform**

Project the luminance adjustment signal of a commercial test disk (0 % (0 IRE or 7.5 IRE) – 100 % (100 IRE)) and adjust.

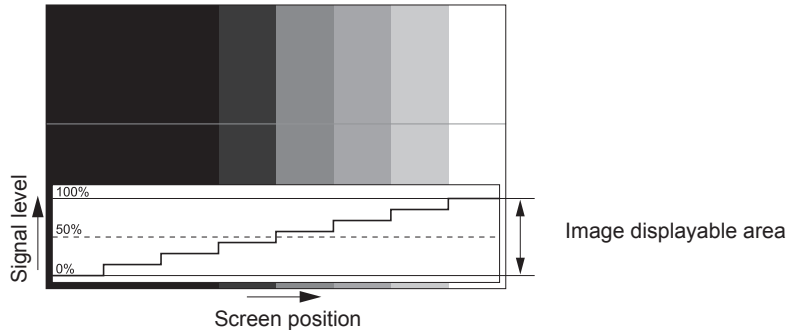

1) Select “Select line (luminance)” on the waveform monitor.

2) Adjust black level.

- Use [BRIGHTNESS] in the on-screen menu [PICTURE] to adjust the black level 0 % of the video signal to the 0 % position of the waveform monitor.

3) Adjust white level.

- Use [CONTRAST] in the on-screen menu [PICTURE] to adjust the white level 100 % of the video signal to the 100 % position of the waveform monitor.

**Adjusting red, green, and blue**

1) Set [COLOR TEMPERATURE] to [USER1] or [USER2] (➔ page 72).

2) Select “Select line (red)” on the waveform monitor.

3) Adjust dark red areas.

- Use [RED] in [WHITE BALANCE LOW] to adjust the black level 0 % of the video signal to the 0 % position of the waveform monitor.

4) Adjust bright red areas.

- Use [RED] in [WHITE BALANCE HIGH] to adjust the white level 100 % of the video signal to the 100 % position of the waveform monitor.

5) Use the procedure for [RED] to adjust [GREEN] and [BLUE].

**Note**

- For DVI-D signal, HDMI signal, SDI signal, and DIGITAL LINK signal, confirm that the [SIGNAL LEVEL] setting is correct before start adjusting the black level.

**[CUT OFF]**

Each red, green, and blue color component can be removed.

1) Press ▲▼ to select [CUT OFF].

2) Press the <ENTER> button.

- The [CUT OFF] screen is displayed.

3) Press ▲▼ to select [RED], [GREEN], or [BLUE].

4) Press ◀▶ to switch the item.

[OFF]	Disables cutoff.
[ON]	Enables cutoff.

**Note**

---

---

- When input is switched or a signal is switched, the cutoff setting returns to its original setting (off).

# [PROJECTOR SETUP] menu

On the menu screen, select [PROJECTOR SETUP] from the main menu, and select an item from the sub-menu.

Refer to “Navigating through the menu” (➔ page 65) for the operation of the menu screen.

- After selecting the item, press ▲▼◀▶ to set.

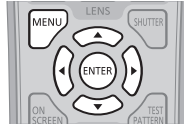

## [PROJECTOR ID]

The projector has an ID number setting function that can be used when multiple projectors are used side by side to enable simultaneous control or individual control via a single remote control.

1) Press ▲▼ to select [PROJECTOR ID].

2) Press ◀▶ to switch the item.

- The items will switch each time you press the button.

[ALL]	Select when controlling projectors without specifying an ID number.
[1] - [64]	Select when specifying an ID number to control individual projector.

### Note

- To specify an ID number for individual control, the ID number of a remote control must match the ID number of the projector.
- When the ID number is set to [ALL], the projector will operate regardless of the ID number specified during remote control or computer control.  
If multiple projectors are set up side by side with IDs set to [ALL], they cannot be controlled separately from the projectors with other ID numbers.
- Refer to “Setting the remote control ID numbers” (➔ page 29) for how to set the ID number on the remote control.

## [PROJECTION METHOD]

Set the projection method in accordance with the installation status of the projector.

Change the projection method if the screen display is upside down or inverted.

1) Press ▲▼ to select [PROJECTION METHOD].

2) Press the <ENTER> button.

- The [PROJECTION METHOD] screen is displayed.

3) Press ▲▼ to select the projection method.

[FRONT/FLOOR]	When installing the projector on the desk, etc., in front of the screen
[FRONT/CEILING]	When installing the projector in front of the screen using the Ceiling Mount Bracket (optional)
[REAR/FLOOR]	When installing the projector on the desk, etc., behind the screen (with a translucent screen)
[REAR/CEILING]	When installing the projector behind the screen (with a translucent screen) using the Ceiling Mount Bracket (optional)

4) Press the <ENTER> button.

5) When the confirmation screen is displayed, press ◀▶ to select [OK], and press the <ENTER> button.

### Attention

- When the [PROJECTION METHOD] setting is changed, confirm that [COOLING CONDITION] (➔ page 109) is set correctly.



## [COOLING CONDITION]

Change the fan control depending on the direction of projection.

Set [COOLING CONDITION] according to the projection direction, but set it to [AUTO] normally. Using the projector with [COOLING CONDITION] set incorrectly may shorten the life of the lamp.

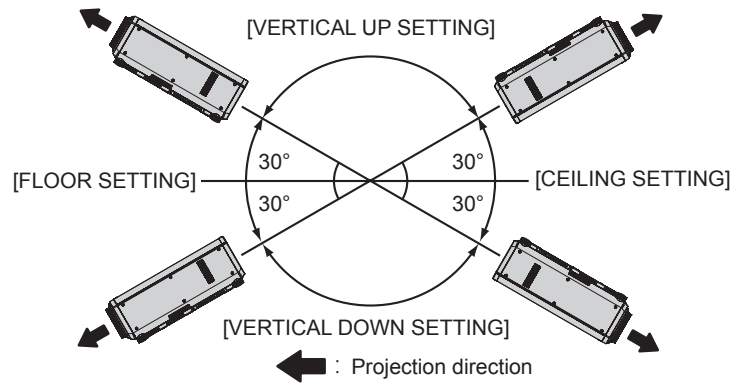

- 1) Press ▲▼ to select [COOLING CONDITION].
- 2) Press the <ENTER> button.
  - The [COOLING CONDITION] screen is displayed.
- 3) Press ▲▼ to select a cooling condition.
  - When [AUTO] is selected, the cooling conditions of [FLOOR SETTING], [CEILING SETTING], [VERTICAL UP SETTING], and [VERTICAL DOWN SETTING] are set automatically.
  - You can check the setting from [COOLING CONDITION] on the [STATUS] screen.
- 4) Press the <ENTER> button.
- 5) When the confirmation screen is displayed, press ◀▶ to select [OK], and press the <ENTER> button.

## [HIGH ALTITUDE MODE]

Set to [ON] when using the projector at high altitudes between 1 400 m (4 593') or higher and lower than 2 700 m (8 858') above sea level.

- 1) Press ▲▼ to select [HIGH ALTITUDE MODE].
- 2) Press ◀▶ to switch the item.

[OFF]	When using at a location lower than 1 400 m (4 593') above sea level
[ON]	When using at high altitudes (1 400 m (4 593') or higher and lower than 2 700 m (8 858') above sea level)

- 3) When the confirmation screen is displayed, press ◀▶ to select [OK], and press the <ENTER> button.

### Note

- The speed of the fan increases and the operation sound becomes louder when set to [ON].

## [LAMP SELECT]

Select the lamp to be turned on from the two built-in luminous lamps according to the use conditions or purposes.

- 1) Press ▲▼ to select [LAMP SELECT].
- 2) Press ◀▶ to switch the item.

[DUAL]	Two lamps will light.
[SINGLE]	One lamp will light. (The lamp with shorter runtime will automatically light.)
[LAMP1]	Lamp 1 will light.
[LAMP2]	Lamp 2 will light.

- 3) Press the <ENTER> button.

**Note**

- When [SINGLE], [LAMP1], or [LAMP2] is selected, if the lamp turns off or when the runtime exceeds 3 000 hours (when [LAMP POWER] is set to [NORMAL]), the other lamp turn on. When [DUAL] is selected, if either lamp turns off or when the runtime exceeds 3 000 hours (when [LAMP POWER] is set to [NORMAL]), only one lamp remains on. However, if both lamps turn off or when operation times of both lamps exceed 3 000 hours (when [LAMP POWER] is set to [NORMAL]), the projector turns into standby.
- The colors of the items indicate the status.

<b>Green</b>	Current setting
<b>Yellow</b>	Current setting (when there is a lamp that cannot turn on or failed to turn on)
<b>Red</b>	Lamp that has failed to turn on
<b>White</b>	Any other status

- When the lamp is repeatedly used in a short-time cycle, the life of the lamp shortens.

**[LAMP RELAY]**

Switch the lamp to be turned on automatically by specifying the day of the week and time.

The degradation of the lamp due to continuous usage can be reduced by automatically switching the lamp to be turned on when using the projector continuously for a week or more.

1) Press ▲▼ to select [LAMP RELAY].

2) Press ◀▶ to switch the item.

<b>[OFF]</b>	Disables lamp relay.
<b>[24H]</b>	Switches the lamp daily.
<b>[1WEEK]</b>	Switches the lamp weekly.

- When [24H] or [1WEEK] is selected, proceed to Step 3).

3) Press ▲▼ to select [TIME].

4) Press the <ENTER> button.

- Enters adjustment mode (the display is blinking).

5) Press ◀▶ to select “hour” or “minute”, and press ▲▼ or the number (<0> - <9>) buttons to set a time.

- Selecting “hour” allows setting of only the hour in increments of one hour, and selecting “minute” allows setting of only the minute in increments of one minute between 00 and 59.

6) Press the <ENTER> button.

- The adjusted time is established.
- When [1WEEK] is selected in Step 2), proceed to Step 7).

7) Press ▲▼ to select [DAY OF THE WEEK].

8) Press ◀▶ to switch the item.

<b>[SUNDAY]</b>	Switches the lamp automatically on the set day of the week.
<b>[MONDAY]</b>	
<b>[TUESDAY]</b>	
<b>[WEDNESDAY]</b>	
<b>[THURSDAY]</b>	
<b>[FRIDAY]</b>	
<b>[SATURDAY]</b>	

**Note**

- The [LAMP RELAY] function is enabled when [DUAL] or [SINGLE] is selected in [LAMP SELECT].
- When [DUAL] is selected in [LAMP SELECT], only one lights for four hours from the specified time.
- The operating time will be the local time. (➔ page 121)

## [LAMP POWER]

Switch the brightness of the lamp according to the operating environment of the projector or the purpose.

- 1) Press ▲▼ to select [LAMP POWER].
- 2) Press ◀▶ to switch the item.

[NORMAL]	Select when high luminance is required.
[ECO]	Select when high luminance is not required.

### Note

- When [ECO] is set, you can reduce power consumption and operation noise, and extend the life of the lamp.

## [BRIGHTNESS CONTROL]

The projector is equipped with a luminance sensor to measure brightness and functions to correct screen brightness resulting from changes in lamp brightness.

Use the projector when using multiple projectors to display on multiple screens to reduce changes in overall brightness of the multiple screens due to lamp degradation and suppress variation in brightness to preserve uniformity.

### Setting [BRIGHTNESS CONTROL GAIN]

Adjust the brightness when displaying multiple screens using multiple projectors.

- 1) Press ▲▼ to select [BRIGHTNESS CONTROL].
- 2) Press the <ENTER> button.
  - The [BRIGHTNESS CONTROL] screen is displayed.
- 3) Press ▲▼ to select [BRIGHTNESS CONTROL GAIN].
- 4) Press ◀▶ to adjust.

Operation	Adjustment		Range of adjustment
	Brightness	Maximum amount of brightness correction	
Press the ▶ button.	The screen becomes brighter.	The maximum amount of correction is reduced.	20 % - 100 %
Press the ◀ button.	The screen becomes darker.	The maximum amount of correction is increased.	

### Note

- When using only one projector, the value obtained by subtracting the value of the [BRIGHTNESS CONTROL GAIN] from 100 % is the maximum amount of brightness correction. Brightness cannot be corrected through brightness control since the maximum amount of correction becomes 0 % when [BRIGHTNESS CONTROL GAIN] is at 100 %.
- Luminance will be unsteady for eight minutes after a lamp is turned on. Make adjustments at least 8 minutes after starting projection.
- The result of [BRIGHTNESS CONTROL GAIN] adjustments is reflected on all image signals, internal test patterns, and on-screen menus.
- The [BRIGHTNESS CONTROL GAIN] setting is enabled even if [BRIGHTNESS CONTROL SETUP] is [OFF].

## Setting [BRIGHTNESS CONTROL SETUP]

Set brightness control operation.

- 1) Press ▲▼ to select [BRIGHTNESS CONTROL].
- 2) Press the <ENTER> button.
  - The [BRIGHTNESS CONTROL] screen is displayed.
- 3) Press ▲▼ to select [BRIGHTNESS CONTROL SETUP].
- 4) Press the <ENTER> button.
  - The [BRIGHTNESS CONTROL SETUP] screen is displayed.
- 5) Press ▲▼ to select [MODE].
- 6) Press ◀▶ to switch the item.
  - The items will switch each time you press the button.

[OFF]	Does not correct the brightness of the screen by the brightness sensor.
[AUTO]	Corrects the brightness of the screen by the brightness sensor. Automatically corrects screen brightness when lamp brightness changes.
[PC]	Synchronizes nine or more projectors through a computer using the dedicated software "Multi Projector Monitoring & Control Software"*1.

\*1 "Multi Projector Monitoring & Control Software" is included in the supplied CD-ROM.

- When [AUTO] is selected, proceed to Step 7).

- 7) Press ▲▼ to select [LINK].
- 8) Press ◀▶ to switch the item.
  - The items will switch each time you press the button.

[OFF]	Performs corrections by the brightness sensor in one projector without synchronizing with the other projectors. The period, in which the constant brightness kept by the small value of [BRIGHTNESS CONTROL GAIN], is prolonged.
[GROUP A] [GROUP B] [GROUP C] [GROUP D]	Synchronizes corrections in multiple projectors by the brightness sensor. You can set up to four groups (A to D) within the same subnet by using the network function. You can also register and synchronize up to eight projectors in one group.

- 9) Press ▲▼ to select [CALIBRATION TIME].
- 10) Press the <ENTER> button.
  - Enters adjustment mode (the display is blinking).
- 11) Press ◀▶ to select "hour" or "minute", and press ▲▼ or the number (<0> - <9>) buttons to set a time.
  - Selecting "hour" allows setting of only the hour in increments of one hour, and selecting "minute" allows setting of only the minute in increments of one minute between 00 and 59.
  - If you do not specify the time, select [OFF] between 23 and 00 o'clock or between 59 and 00 minutes.
- 12) Press the <ENTER> button.
  - [CALIBRATION TIME] is set.
  - Measures the brightness at the specified time. Iris is fixed to open during measurement.
- 13) Press ▲▼ to select [CALIBRATION MESSAGE].
- 14) Press ◀▶ to switch the item.
  - The items will switch each time you press the button.

[ON]	Messages are displayed during calibration.
[OFF]	Messages are not displayed during calibration.

- 15) Press ▲▼ to select [APPLY].

16) Press the <ENTER> button.

- The set [MODE] and [LINK] are enabled, and LAMP RELAY screen alert is displayed when the [LAMP RELAY] setting is [OFF]. When [CALIBRATION MESSAGE] is set to [ON], a calibration running message is displayed which will automatically disappear 30 seconds after calibration completes.
- If the <ENTER> button is pressed with [MODE] in [BRIGHTNESS CONTROL SETUP] set to other than [OFF], the brightness of the lamp at the time the button was pressed is recorded as the standard brightness.
- If the <ENTER> button is pressed when [LINK] is set from [GROUP A] to [GROUP D], the group name is displayed on the screens of projectors that have been set in the same group.



Note

- When [MODE] in [BRIGHTNESS CONTROL SETUP] is set to [AUTO] or [PC], keep the shutter open for at least two minutes to perform the brightness sensor calibration after completed the [BRIGHTNESS CONTROL SETUP] setting.
- If the shutter is closed within approx. 10 minutes after the lamp has turned on while [MODE] in [BRIGHTNESS CONTROL SETUP] is set to [AUTO] or [PC], brightness cannot be measured. Therefore, brightness may be corrected approx. two minutes after the shutter opens.
- When [MODE] in [BRIGHTNESS CONTROL SETUP] is set to [AUTO] or [PC], the lamp brightness is automatically measured eight minutes after the lamp is turned on, and correction is performed so that the screen brightness will be the same as the standard brightness when the brightness control is adjusted. Lamp brightness cannot be measured during the eight minutes after it is turned on because it is not steady.
- If a lamp turns off or lamp relay is performed while [MODE] in [BRIGHTNESS CONTROL SETUP] is set to [AUTO] and when [DUAL] is set in the [PROJECTOR SETUP] menu → [LAMP SELECT], brightness is corrected to the possible extent one minute later.
- When [MODE] in [BRIGHTNESS CONTROL SETUP] is set to [AUTO] and [LINK] is set to [OFF], brightness will be corrected until it reaches the maximum amount of correction.
- The variation in brightness may increase due to dust accumulating on the lens, screen, or inside the projector, depending on the installation environment of the projector.
- Adjust brightness control again when lamp degradation causes increased variation in brightness or a lamp is replaced.
- For continued use longer than 24 hours, set the [BRIGHTNESS CONTROL SETUP] to [CALIBRATION TIME], or set [LAMP RELAY] (➡ page 110). If it is not set, correction will not be performed automatically.
- Brightness control and dynamic iris operate simultaneously, but the iris is fully open and does not operate while a brightness measurement is performed.
- The [CALIBRATION TIME] setting will be reflected at the time when you enter the time.
- The [CALIBRATION MESSAGE] setting will be reflected at the time when items are switched using ◀▶.

Displaying [BRIGHTNESS CONTROL STATUS]

Display the brightness control status.

- 1) Press ▲▼ to select [BRIGHTNESS CONTROL].
- 2) Press the <ENTER> button.
  - The [BRIGHTNESS CONTROL] screen is displayed.
- 3) Press ▲▼ to select [BRIGHTNESS CONTROL STATUS].
- 4) Press the <ENTER> button.
  - The [BRIGHTNESS CONTROL STATUS] screen is displayed.

[BRIGHTNESS CONTROL STATUS] screen display example

When [MODE] of [BRIGHTNESS CONTROL SETUP] is set to [OFF]  
The screen shows the status that the brightness control is disabled.

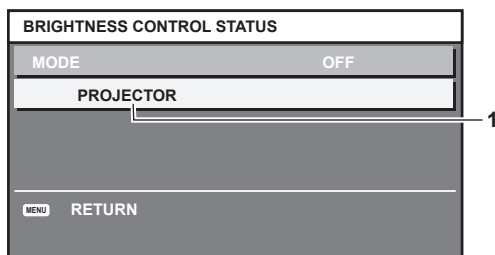

When [MODE] of [BRIGHTNESS CONTROL SETUP] is set to [AUTO] and [LINK] is set to [OFF]  
The screen shows the status of the brightness control in one projector.

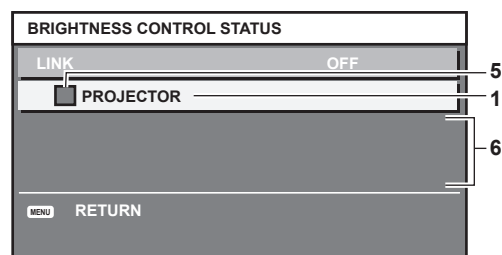

When [MODE] of [BRIGHTNESS CONTROL SETUP] is set to [AUTO] and [LINK] is set from [GROUP A] to [GROUP D]

The screen shows the status of the brightness control of synchronized projectors (up to eight units), including the projector being controlled through the on-screen menu.

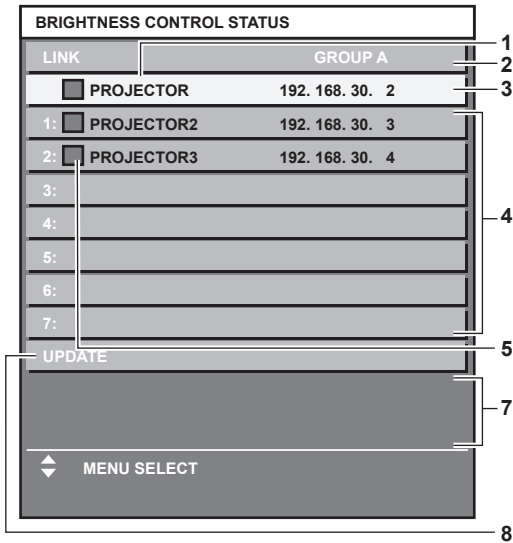

When [MODE] of [BRIGHTNESS CONTROL SETUP] is set to [PC]

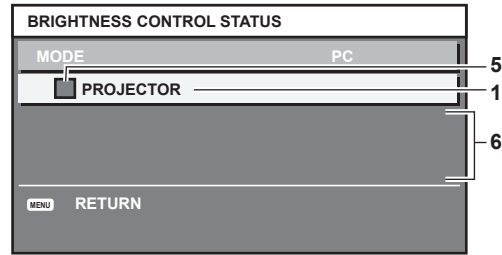

- 1 Display the name of the projector.
- 2 Display the synchronized group.
- 3 Display the IP address of the projector.
- 4 Display the names and IP addresses of projectors in same group detected over the network.
- 5 Display the status by color.  
Green: There is an allowance for brightness correction.  
Yellow: There is little allowance for brightness correction.  
Red: There is a brightness control error.
- 6 Display error detailed messages.
- 7 Display error messages.  
When the message [Failed to apply BRIGHTNESS CONTROL to some projectors.] appears, it means that synchronization with the projector displayed in red has failed.  
Press ▲▼ to select the projector displayed in red, and press the <ENTER> button to display the error details.
- 8 Update to the latest status information.

■ Error details

Error message	Measures to take
[Exceed maximum number of projectors.]	<ul style="list-style-type: none"> <li>• Limit the number of projectors in one group to eight.</li> <li>• When synchronizing nine or more projectors, use the dedicated software “Multi Projector Monitoring &amp; Control Software”<sup>*1</sup> through a computer.</li> </ul>
[Please check the COMMAND CONTROL setting.]	<ul style="list-style-type: none"> <li>• Set [NETWORK CONTROL] → [COMMAND CONTROL] to [ON] for the projector in error.</li> <li>• Set [NETWORK CONTROL] → [COMMAND PORT] of all projectors to be linked to the same value.</li> </ul>
[Please check the USER NAME and PASSWORD in the COMMAND CONTROL setting.]	<ul style="list-style-type: none"> <li>• Assign the same [User name] and [Password] strings that have web control administrator rights to all projectors to be linked.</li> </ul>
[Cannot apply BRIGHTNESS CONTROL. Please check projector status.]	<ul style="list-style-type: none"> <li>• The projector is in standby. Switch on the power.</li> </ul>
[Brightness Sensor Error]	<ul style="list-style-type: none"> <li>• There is a problem with the brightness sensor. If problems persist even after switching on the power, consult your dealer.</li> </ul>

\*1 “Multi Projector Monitoring & Control Software” is included in the supplied CD-ROM.

**Note**

- If the synchronized projectors are not displayed in the list, check the following:
  - Are there devices with the same IP address on the network?
  - Are the LAN cables connected correctly? (➡ page 137)
  - Are the subnets of the projectors the same?
  - Are the same [LINK] settings applied to a group?
- Refer to [NETWORK SETUP] (➡ page 135) or “[Network config] page” (➡ page 145) on how to change the projector name.

### Brightness control adjustment procedure example

---

The steps exemplify an adjustment to link the brightness of eight projectors connected in a network.

- 1) **Connect all projectors to the hub using LAN cables. (➔ page 137)**
- 2) **Switch on all projectors and start projection.**
- 3) **Set [LAMP SELECT] to either [DUAL] or [SINGLE] for all projectors.**
- 4) **Set [MODE] of [BRIGHTNESS CONTROL SETUP] to [OFF], and select [APPLY], and then press the <ENTER> button.**
- 5) **Set [SUBNET MASK] and [IP ADDRESS] in each projector.**
  - To be able to communicate over the network, set the same value in [SUBNET MASK] for all projectors and set a different value in [IP ADDRESS] for each projector.
- 6) **Wait for at least eight minutes after starting projection until the lamp brightness becomes steady.**
- 7) **Set all items in the [PICTURE] menu of all projectors to the same values.**
- 8) **Adjust [COLOR MATCHING] to match colors.**
- 9) **Display the internal test pattern “All white” in all projectors.**
- 10) **Set [BRIGHTNESS CONTROL GAIN] to 100 % in all projectors.**
- 11) **Set [BRIGHTNESS CONTROL GAIN] to 90 % in the projector with the least brightness.**
- 12) **Adjust [BRIGHTNESS CONTROL GAIN] in each projector.**
  - Adjust [BRIGHTNESS CONTROL GAIN] of all the other projectors so that the brightness is matched to the projector of which [BRIGHTNESS CONTROL GAIN] is set to 90 %.
- 13) **Set [MODE] of [BRIGHTNESS CONTROL SETUP] to [AUTO], and [LINK] to [GROUP A] in all projectors.**
- 14) **Select [APPLY] of [BRIGHTNESS CONTROL SETUP] and press the <ENTER> button in all projectors.**
  - Brightness control starts.

---

#### Note

- Brightness is automatically corrected each time the lamp blinks when the power is switched on or off.
- Adjust brightness control again when lamp degradation causes increased variation in brightness or a lamp is replaced.

## [STANDBY MODE]

Set the power consumption during the standby.

1) Press ▲▼ to select [STANDBY MODE].

2) Press ◀▶ to switch the item.

- The items will switch each time you press the button.

[ECO]	Use this setting to reduce power consumption during standby.
[NORMAL]	Use this setting to use the network function during standby.

### Note

- In the [ECO] setting, the network function, the <SERIAL OUT> terminal, and some RS-232C commands become inoperable during standby. In the [NORMAL] setting, the network function and the <SERIAL OUT> terminal become operable during standby.
- When set to [ECO], it may take approx. 10 seconds longer before the projector starts projecting after the power is turned on, compared with when [NORMAL] is set.

## [SCHEDULE]

Set the command execution schedule for each day of the week.

### Enabling/disabling the schedule function

1) Press ▲▼ to select [SCHEDULE].

2) Press ◀▶ to switch the item.

- The items will switch each time you press the button.

[OFF]	Disables the schedule function.
[ON]	Enables the schedule function. Refer to “How to assign a program” (➔ page 116) or “How to set a program” (➔ page 116) for how to set the schedule.

### Note

- When [SCHEDULE] is set to [ON], the [STANDBY MODE] setting is forcibly switched to [NORMAL], and the setting cannot be changed. Even if [SCHEDULE] is then set to [OFF] when in this state, the setting of [STANDBY MODE] remains at [NORMAL].

### How to assign a program

1) Press ▲▼ to select [SCHEDULE].

2) Press ◀▶ to select [ON], and press the <ENTER> button.

- The [SCHEDULE] screen is displayed.

3) Select and assign program to each day of week.

- Press ▲▼ to select the day of week, and press ◀▶ to select a program number.
- You can set the program from No.1 to No.7. “- -” indicates that the program number has not been set.

### How to set a program

Set up to 16 commands to each program.

1) Press ▲▼ to select [SCHEDULE].

2) Press ◀▶ to select [ON], and press the <ENTER> button.

- The [SCHEDULE] screen is displayed.

3) Press ▲▼ to select [PROGRAM EDIT].

4) Press ◀▶ to select a program number, and press the <ENTER> button.

5) Press ▲▼ to select a command number, and press the <ENTER> button.

- You can change the page using ◀▶.

6) Press ▲▼◀▶ to select [TIME], and press the <ENTER> button.



- 7) Press ◀▶ to select “hour” or “minute”, and press ▲▼ or the number (<0> - <9>) buttons to set a time, and then press the <ENTER> button.
- 8) Press ▲▼◀▶ to select [COMMAND].
- 9) Press the <ENTER> button.
  - The [COMMAND] detailed screen is displayed.
- 10) Press ▲▼ to select a [COMMAND].
  - For [COMMAND] which requires detailed settings, the items of the detailed settings will switch each time you press ◀▶.
  - When [INPUT] is selected, press the <ENTER> button, and then press ▲▼◀▶ to select the input to set.

[COMMAND]	Detailed settings of [COMMAND]	Description
[POWER ON]	—	Switches on the projector.
[STANDBY]	—	Enters standby.
[SHUTTER]	[OPEN]	Opens the shutter.
	[CLOSE]	Closes the shutter.
[INPUT]	[VIDEO]	Switches the input to VIDEO.
	[RGB1]	Switches the input to RGB1.
	[RGB2]	Switches the input to RGB2.
	[DVI-D]	Switches the input to DVI-D.
	[HDMI]	Switches the input to HDMI.
	[DIGITAL LINK]	Switches the input to DIGITAL LINK.
	[SDI]*1	Switches the input to SDI.
	[INPUT1] - [INPUT10]*2	Switches the input to DIGITAL LINK, and switch the input of the Panasonic twisted-pair-cable transmitter to the specified input.
[LAMP SELECT]	[DUAL]	Turns on two lamps.
	[SINGLE]	Turns on one lamp. (The lamp with shorter runtime will automatically light.)
[LAMP POWER]	[NORMAL]	Sets the lamp brightness to high luminance.
	[ECO]	Sets the lamp brightness to low luminance.
[P IN P]	[OFF]	P IN P function is not used.
	[USER1]	Lays out the sub-screen with the settings of [USER1].
	[USER2]	Lays out the sub-screen with the settings of [USER2].
	[USER3]	Lays out the sub-screen with the settings of [USER3].

\*1 Only for PT-DZ870E

\*2 When the Panasonic twisted-pair-cable transmitter (such as the optional Digital Interface Box (Model No.: ET-YFB100G)) is connected to the projector, its input name is reflected from [INPUT1] to [INPUT10] automatically. If an item where the input name is not reflected is selected, it is disabled.

- 11) Press the <ENTER> button.
  - The command is fixed and ● is displayed at the left of the selected command.
  - After the command is fixed, press the <MENU> button to close the detailed setting screen.

- 12) Press ▲▼◀▶ to select [STORE], and press the <ENTER> button.

### Note

- If you attempt to register the setting that would make the lamp turn on for a short time, an error message will be displayed on the screen. Set the time and command again.
- To delete a command already set, press the <DEFAULT> button on the remote control at the screen in Step 5), or select [DELETE] at the screen in Step 6) and press the <ENTER> button.
- If multiple commands have been set for the same time, they are executed in chronological order starting from the smallest command number.
- The operating time will be the local time. (➔ page 121)
- If an operation is executed with the remote control or control panel of the projector or with a control command before the command set in [SCHEDULE] is executed, the command set with this function may not be executed.

### [STARTUP INPUT SELECT]

Set the input when the projector is switched on to start projection.

- 1) Press ▲▼ to select [STARTUP INPUT SELECT].
- 2) Press the <ENTER> button.
  - The [STARTUP INPUT SELECT] screen is displayed.

3) Press ▲▼◀▶ to select an input.

- The items will switch each time you press the button.

[LAST USED]	Keeps the input selected last.
[VIDEO]	Sets the input to VIDEO.
[RGB1]	Sets the input to RGB1.
[RGB2]	Sets the input to RGB2.
[DVI-D]	Sets the input to DVI-D.
[HDMI]	Sets the input to HDMI.
[DIGITAL LINK]	Sets the input to DIGITAL LINK.
[SDI]*1	Sets the input to SDI.
[INPUT1] - [INPUT10]*2	Sets the input to DIGITAL LINK, and switch the input of Panasonic twisted-pair-cable transmitter to the specified input.

\*1 Only for PT-DZ870E

\*2 When the Panasonic twisted-pair-cable transmitter (such as the optional Digital Interface Box (Model No.: ET-YFB100G)) is connected to the projector, its input name is reflected from [INPUT1] to [INPUT10] automatically. If an item where the input name is not reflected is selected, it is disabled.

4) Press the <ENTER> button.

### [RS-232C]

Set the communication conditions of the <SERIAL IN>/<SERIAL OUT> terminal.

#### Setting the communication condition of the <SERIAL IN> terminal

1) Press ▲▼ to select [RS-232C].

2) Press the <ENTER> button.

- The [RS-232C] screen is displayed.

3) Press ▲▼ to select [INPUT SELECT].

4) Press ◀▶ to switch the item.

[PROJECTOR]	Use the <SERIAL IN> terminal of the projector to execute RS-232C communication.
[DIGITAL INTERFACE BOX]	Executes RS-232C communication via the optional Digital Interface Box (Model No.: ET-YFB100G) and the <DIGITAL LINK/LAN> terminal.

5) Press ▲▼ to select [(IN) BAUDRATE].

6) Press ◀▶ to switch the item.

- The items will switch each time you press the button.

[9600]	Select the proper speed.
[19200]	
[38400]	

7) Press ▲▼ to select [(IN) PARITY].

8) Press ◀▶ to switch the item.

- The items will switch each time you press the button.

[NONE]	Select the parity condition.
[EVEN]	
[ODD]	

#### Setting the communication condition of the <SERIAL OUT> terminal

1) Press ▲▼ to select [RS-232C].

2) Press the <ENTER> button.

- The [RS-232C] screen is displayed.

3) Press ▲▼ to select [(OUT) BAUDRATE].

4) Press ◀▶ to switch the item.

[9600]	Select the proper speed.
[19200]	
[38400]	

5) Press ▲▼ to select [(OUT) PARITY].

6) Press ◀▶ to switch the item.

- The items will switch each time you press the button.

[NONE]	Select the parity condition.
[EVEN]	
[ODD]	

### Setting the response

1) Press ▲▼ to select [RS-232C].

2) Press the <ENTER> button.

- The [RS-232C] screen is displayed.

3) Press ▲▼ to select [RESPONSE(ID ALL)].

4) Press ◀▶ to switch the item.

[ON]	Returns the response when the ID setting is ALL.
[OFF]	Does not return the response when the ID setting is ALL.

5) Press ▲▼ to select [GROUP].

6) Press ◀▶ to switch the item.

[A] - [Z]	Controls multiple projectors simultaneously by sending the ID of RS-232C. You can set groups from [A] to [Z]. The projector responds when the ID of RS-232C matches the setting.
-----------	--

7) Press ▲▼ to select [RESPONSE(ID GROUP)].

8) Press ◀▶ to switch the item.

[ON]	Returns the response when the ID setting is GROUP.
[OFF]	Does not return the response when the ID setting is GROUP.

### Note

- When [INPUT SELECT] is set to [DIGITAL INTERFACE BOX], communication using that serial terminal is available only when the corresponding device (such as the optional Digital Interface Box (Model No.: ET-YFB100G)) is connected to the <DIGITAL LINK/LAN> terminal.
- When transferring logos via the optional Digital Interface Box (Model No.: ET-YFB100G), "NO SIGNAL SLEEP" of ET-YFB100G must be set to "OFF" to avoid cutting off communication.
- When [INPUT SELECT] is set to [DIGITAL INTERFACE BOX], communication speed is fixed to 9 600 bps.

### [STATUS]

Display the status of the projector.

1) Press ▲▼ to select [STATUS].

2) Press the <ENTER> button.

- The [STATUS] screen is displayed.

3) Press ◀▶ to switch the pages.

- The page will change each time you press the button.

[INPUT]	Displays the input terminal currently selected.
[SIGNAL NAME]	Displays the input signal name.

[SIGNAL FREQUENCY]	Displays the frequency of the input signal.	
[PROJECTOR RUNTIME]	Displays the operation times of the projector.	
[LAMP1] <sup>*2</sup>	Displays the runtime and status of Lamp 1.	
[LAMP2] <sup>*2</sup>	Displays the runtime and status of Lamp 2.	
[INTAKE AIR TEMP.]	Displays the status of the air intake temperature of the projector.	
[OPTICS MODULE TEMP.]	Displays the status of the internal temperature of the projector.	
[AROUND LAMP TEMP.]	Displays the status of the temperature around the lamps of the projector.	
[PROJECTOR TYPE]	Displays the type of the projector.	
[SERIAL NUMBER]	Displays the serial number of the projector.	
[LAMP UNIT MODEL NO.]	Displays the model no. of the lamp unit.	
[LAMP1 SERIAL NUMBER]	Displays the serial number of the lamp 1.	
[LAMP2 SERIAL NUMBER]	Displays the serial number of the lamp 2.	
[MAIN VERSION]	Displays the main version of the firmware of the projector.	
[SUB VERSION]	Displays the sub version of the firmware of the projector.	
[UPGRADE(ET-UK20)] <sup>*1</sup>	Displays the activation status based on the Upgrade Kit.	
[ON COUNT]	[POWER ON TIMES]	Displays the number of times the power is turned on.
	[LAMP1 ON]	Displays the number of times the lamp is turned on.
	[LAMP2 ON]	
	[SHUTTER]	Displays the number of times the shutter is closed.
[LAMP1]	Displays runtime in detail.	
[LAMP2]	Displays runtime in detail.	
[NUMBER OF REGISTERED SIGNAL]	Displays the number of registered signals.	
[REMOTE2 STATUS]	Displays the control status of the REMOTE2.	
[AC VOLTAGE]	Displays the status of the AC voltage.	
[COOLING CONDITION]	Displays the set cooling conditions. When [AUTO] is set, automatically recognized result is displayed.	
[SIGNAL INFORMATION]	[MEMORY NO.]	Displays the memory number of the input signal.
	[INPUT]	Displays the input terminal currently selected.
	[SIGNAL NAME]	Displays the input signal name.
	[SIGNAL FREQUENCY]	Displays the frequency of the input signal.
	[SYNC.STATE]	Displays the synch polarity of the input signal.
	[V.SYNC WIDTH]	Displays the vertical sync signal pulse width of the input signal.
	[SCAN TYPE]	Displays the scan type of the input signal.
	[TOTAL DOTS]	Displays the total dot count of the input signal.
	[DISPLAY DOTS]	Displays the number of input signal display dots.
	[TOTAL LINES]	Displays the total line count of the input signal.
	[DISPLAY LINES]	Displays the number of input signal display lines.
	[SAMPLING]	Displays the sampling information of the input signal.
	[SIGNAL LEVEL]	Displays the signal level of the input signal.
[BIT DEPTH] <sup>*1</sup>	Displays the gradation of the input signal.	

\*1 Only for PT-DZ870E

\*2 The lamp runtime to be displayed is real time. The following conversion is required to calculate the rough estimate for lamp replacement.

Formula for lamp replacement time (rough estimate)
$(A \times 4 + B \times 3) \div 4$ <ul style="list-style-type: none"> <li>• A: Runtime when [LAMP POWER] is set to [NORMAL]</li> <li>• B: Runtime when [LAMP POWER] is set to [ECO]</li> </ul>

### Note

- The content of status can be sent via E-mail by pressing the <ENTER> button while displaying the [STATUS] screen.
- Some items in [SIGNAL INFORMATION] may be displayed and others not displayed, depending on the signal being input.

## [NO SIGNAL SHUT-OFF]

A function that automatically switches the power source of the projector to standby if there is no input signal for a certain period of time. The time before switching to standby can be set.

- 1) Press ▲▼ to select [NO SIGNAL SHUT-OFF].
- 2) Press ◀▶ to switch the item.
  - The items will switch each time you press the button.

[DISABLE]	Disables the No signal shut-off function.
[10MIN.] - [90MIN.]	Allows you to set in ten minutes intervals.

## [REMOTE2 MODE]

You can set the <REMOTE 2 IN> terminal.

1) Press ▲▼ to select [REMOTE2 MODE].

2) Press ◀▶ to switch the item.

- The items will switch each time you press the button.

[DEFAULT]	The pin assignment of the <REMOTE 2 IN> terminal is used by the factory default setting of the projector.
[USER]	Used to change the setting of the <REMOTE 2 IN> terminal.
[L6500 SERIES]	The setting of <REMOTE 2 IN> terminal is used for the L6500 series compatibility.

- When [USER] is selected, proceed to Step 3).

3) Press the <ENTER> button.

4) Press ▲▼ to select one from [PIN2] to [PIN8], and press ◀▶ to switch the setting.

## [FUNCTION BUTTON]

Set the functions of the <FUNCTION> button on the remote control.

1) Press ▲▼ to select [FUNCTION BUTTON].

2) Press the <ENTER> button.

- The [FUNCTION BUTTON] screen is displayed.

3) Press ▲▼ to select a function.

[DISABLE]	Disables the <FUNCTION> button.
[P IN P]	Switches the [P IN P] setting to [OFF], [USER1], [USER2], or [USER3]. (➔ page 124)
[SUB MEMORY]	Displays the sub memory list. (➔ page 129)
[SYSTEM SELECTOR]	Switches the [SYSTEM SELECTOR] setting. (➔ page 76)
[SYSTEM DAYLIGHT VIEW]	Switches the [SYSTEM DAYLIGHT VIEW] setting. (➔ page 74)
[FREEZE]	Temporarily pauses the image. (➔ page 105)
[WAVEFORM MONITOR]	Displays the waveform of the input signal. (➔ page 105)
[LEFT/RIGHT SWAP]	Switches the flip horizontal settings. (➔ page 92)
[ASPECT]	Switches the aspect setting. (➔ page 78)

4) Press the <ENTER> button.

## [DATE AND TIME]

Set the time zone, date, and time of the built-in clock of the projector.

### Setting the time zone

1) Press ▲▼ to select [DATE AND TIME].

2) Press the <ENTER> button.

- The [DATE AND TIME] screen is displayed.

3) Press ▲▼ to select [TIME ZONE].

4) Press ◀▶ to switch [TIME ZONE].

### Setting the date and time manually

1) Press ▲▼ to select [DATE AND TIME].

- 2) **Press the <ENTER> button.**
  - The [DATE AND TIME] screen is displayed.
- 3) **Press ▲▼ to select [ADJUST CLOCK].**
- 4) **Press the <ENTER> button.**
  - The [ADJUST CLOCK] screen is displayed.
- 5) **Press ▲▼ to select an item, and press ◀▶ to set the local date and time.**
- 6) **Press ▲▼ to select [APPLY], and press the <ENTER> button.**
  - The setting of the date and time will be completed.

### Setting the date and time automatically

- 1) **Press ▲▼ to select [DATE AND TIME].**
- 2) **Press the <ENTER> button.**
  - The [DATE AND TIME] screen is displayed.
- 3) **Press ▲▼ to select [ADJUST CLOCK].**
- 4) **Press the <ENTER> button.**
  - The [ADJUST CLOCK] screen is displayed.
- 5) **Press ▲▼ to select [NTP SYNCHRONIZATION], and press ◀▶ to change the setting to [ON].**
- 6) **Press ▲▼ to select [APPLY], and press the <ENTER> button.**
  - The setting of the date and time will be completed.

### Note

- To set the date and time automatically, the projector must be connected to the network.
- If synchronization with the NTP server fails just after [NTP SYNCHRONIZATION] is turned [ON], or if [NTP SYNCHRONIZATION] is turned [ON] while the NTP server is not set, [NTP SYNCHRONIZATION] will return to [OFF].
- Access the projector via a web browser to set the NTP server. Refer to “[Adjust clock] page” (➔ page 146) for details.

## [LENS CALIBRATION]

Automatically set the lens shift limit values and home position for the projector.

- 1) **Press ▲▼ to select [LENS CALIBRATION].**
- 2) **Press the <ENTER> button.**
  - The confirmation screen is displayed.
- 3) **Press ◀▶ to select [OK], and press the <ENTER> button.**
  - To cancel, select [CANCEL].
  - The lens moves up, down, left, and right to automatically set the lens shift limit values and home position.
  - The lens stops to complete the calibration.

### Note

- [PROGRESS] is displayed on the menu during lens calibration. Cannot cancel mid-operation.
- When lens calibration executes correctly, [COMPLETE] is displayed and [INCOMPLETE] is displayed when it does not execute correctly.

## [SAVE ALL USER DATA]

Save the various setting values as a backup in the built-in memory of the projector.

- 1) **Press ▲▼ to select [SAVE ALL USER DATA].**
- 2) **Press the <ENTER> button.**
  - The [SECURITY PASSWORD] screen is displayed.
- 3) **Enter a security password and press the <ENTER> button.**
- 4) **When the confirmation screen is displayed, press ◀▶ to select [OK], and press the <ENTER> button.**
  - [PROGRESS] is displayed while saving data.

**Note**

- Data set from the computer application is not included in [ALL USER DATA].

**[LOAD ALL USER DATA]**

Load the various setting values saved as a backup in the built-in memory of the projector.

- 1) Press ▲▼ to select [LOAD ALL USER DATA].
- 2) Press the <ENTER> button.
  - The [SECURITY PASSWORD] screen is displayed.
- 3) Enter a security password and press the <ENTER> button.
- 4) When the confirmation screen is displayed, press ◀▶ to select [OK], and press the <ENTER> button.

**Note**

- The projector will go into the standby status to reflect the setting values when [LOAD ALL USER DATA] is executed.
- Data registered from a computer is not included in [ALL USER DATA].

**[INITIALIZE]**

Return various setting values to their factory default settings.

- 1) Press ▲▼ to select [INITIALIZE].
- 2) Press the <ENTER> button.
  - The [SECURITY PASSWORD] screen is displayed.
- 3) Enter a security password and press the <ENTER> button.
  - The [INITIALIZE] screen is displayed.
- 4) Press ▲▼ to select an item to initialize.

[ALL USER DATA]	Returns all setting items including [REGISTERED SIGNAL], [NETWORK SETUP], [E-mail set up], and [USER LOGO] to the factory default settings. The projector will go into the standby status to reflect the setting values.
[REGISTERED SIGNAL]	Deletes all the setting values saved for each input signal. To delete only a part of a registered signal, perform the procedure described in “Deleting the registered signal” (▶ page 127).
[NETWORK/E-MAIL]	Returns [NETWORK SETUP] and [E-mail set up] to factory default settings.
[LOGO IMAGE]	Deletes the image registered in [USER LOGO].

- 5) Press the <ENTER> button.
- 6) When the confirmation screen is displayed, press ◀▶ to select [OK], and press the <ENTER> button.

**[SERVICE PASSWORD]**

This function is used by a service person.

## [P IN P] menu

On the menu screen, select [P IN P] from the main menu, and select an item from the sub-menu.

Refer to “Navigating through the menu” (➔ page 65) for the operation of the menu screen.

- After selecting the item, press ▲▼◀▶ to set.

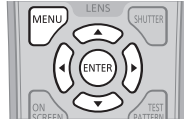

### Using P IN P function

Locate a separate, small sub screen in the main screen to project two images simultaneously.

- 1) Press ▲▼ to select [P IN P MODE].
- 2) Press the <ENTER> button.
  - The [P IN P MODE] screen is displayed.
- 3) Press ▲▼ to select a function.

[OFF]	P IN P function is not used.
[USER1]	The items set in “Setting P IN P function” (➔ page 124) are used in P IN P function.
[USER2]	
[USER3]	

- 4) Press the <ENTER> button.

### Setting P IN P function

P IN P function settings can be saved to [USER1], [USER2], and [USER3].

- 1) Press ▲▼ to select [P IN P MODE].
- 2) Press the <ENTER> button.
  - The [P IN P MODE] screen is displayed.
- 3) Press ▲▼ to select the desired mode from [USER1], [USER2], and [USER3], and press the <ENTER> button.
- 4) Press ▲▼ to select [MAIN WINDOW] or [SUB WINDOW], and press the <ENTER> button.
- 5) Press ▲▼ to select the input terminal to be displayed in the window, and press the <ENTER> button.
- 6) Press ▲▼ to select an item.

[SIZE]	Set the window display size between 10 % and 100 %.
[POSITION]	Set the display position of the window within the screen.
[CLOCK PHASE]	When the sub window is input from the <RGB 1 IN> terminal or the <RGB 2 IN> terminal and a flickering image or smeared outline appears, set between 0 and +31.

- 7) If [SIZE] is selected in Step 6), press the <ENTER> button.
  - The sub-menu is displayed.
- 8) Press ▲▼ to select an item.
- 9) Press ◀▶ to make adjustment, and press the <MENU> button.
- 10) If [POSITION] is selected in Step 6), press the <ENTER> button.
- 11) Press ▲▼◀▶ to adjust the position, and press the <MENU> button.
- 12) If [CLOCK PHASE] is selected in Step 6), press ◀▶ to make adjustment.
- 13) Press ▲▼ to select [FRAME LOCK].



14) Press ◀▶ to switch the item.

[MAIN WINDOW]	Set frame lock to the input signal set in the main window.
[SUB WINDOW]	Set frame lock to the input signal set in the sub window.

15) Press ▲▼ to select [TYPE].

16) Press ◀▶ to switch the item.

[MAIN WINDOW]	The main window has display priority.
[SUB WINDOW]	The sub window has display priority.

### Note

- The P IN P function may not be available for some signals being input or terminals being selected. Refer to “Two-window display combination list” (▶ page 177) for details.
- The main window setting values are applied to image adjustment values such as [PICTURE MODE], [GAMMA], and [COLOR TEMPERATURE].
- On the main screen (when no menu is displayed), press ◀▶ to switch the sizes and positions of the main window and sub window while P IN P is operating.
- When [FRAME RESPONSE] is set to other than [NORMAL], [P IN P] cannot be set.
- 3D images cannot be displayed in P IN P.
- The P IN P state continues while the P IN P function is used, even if 3D images of the simultaneous system are displayed.
- The combination of DIGITAL LINK and other input cannot be displayed in P IN P.

## [TEST PATTERN] menu

On the menu screen, select [TEST PATTERN] from the main menu.  
Refer to “Navigating through the menu” (➔ page 65) for the operation of the menu screen.

- Press ◀▶ to switch.

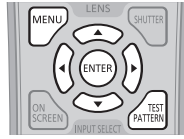

### [TEST PATTERN]

Display the test pattern built-in to the projector.

Settings of position, size, and other factors will not be reflected in test patterns. Make sure to display the input signal before performing various adjustments.

#### 1) Press ◀▶ to switch the [TEST PATTERN] item.

- The items will switch each time you press the button.

Menu screen + All white	
Menu screen + All black	
Menu screen + Window	
Menu screen + Window (inversion)	
Menu screen + Color bar (vertical)	Displays test patterns with the menu screen. Select a test pattern so that it is easy to make various adjustments.
Menu screen + Color bar (horizontal)	
Menu screen + 16:9/4:3 aspect frame	
Menu screen + Focus	
Menu screen + Entry screen	Displays the menu screen and input signal. Built-in test patterns are not displayed.

#### Note

- Press the <ON SCREEN> button on the remote control while the test pattern is displayed to hide the menu screen.

### Changing color or a focus test pattern

When the “Menu Screen + Focus” test pattern is displayed, the color can be changed.

#### 1) Press ◀▶ to select the “Menu Screen + Focus” test pattern.

#### 2) Press the <ENTER> button.

- The [TEST PATTERN COLOR] screen is displayed.

#### 3) Press ▲▼ to select a color, and press the <ENTER> button.

- The test pattern color changed to the color selected.

#### Note

- The test pattern color settings return to [WHITE] when the projector is switched off.
- Colors of the test patterns other than focus test patterns cannot be changed.

## [SIGNAL LIST] menu

On the menu screen, select [SIGNAL LIST] from the main menu.  
Refer to “Navigating through the menu” (➔ page 65) for the operation of the menu screen.



### ■ Registered signal details

Memory number: A1 (1-2)

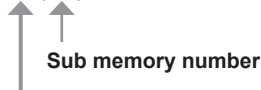

When the address number (A1, A2, ... L7, L8) signal is registered

- A name can be set for each sub memory (➔ page 129).

### Registering new signals

After a new signal is input and the <MENU> button on the remote control or the control panel is pressed, the registration is completed and the [MAIN MENU] screen is displayed.

#### Note

- Up to 96 signals, including sub memories, can be registered to the projector.
- There are 12 pages (eight memories of A through L, with eight memories possible on each page) for memory numbers, and the signal is registered to the lowest number that is available. If there is no available memory number it will be overwritten from the oldest signal.
- The names to be registered are automatically determined by the input signals and memory numbers.
- If a menu is being displayed, the new signals will be registered at the instant they are input.

### Renaming the registered signal

Registered signals can be renamed.

- 1) Press **▲▼◀▶** to select the signal of which name is to be changed.
- 2) Press the <ENTER> button.
  - The [REGISTERED SIGNAL STATUS] screen is displayed.
  - The memory number, input terminal, input signal name, frequency, synch polarity, etc., are displayed.
  - Press the <MENU> button to return to the [SIGNAL LIST] screen.
- 3) Press the <ENTER> button.
  - The [REGISTERED SIGNAL SETUP] screen is displayed.
- 4) Press **▲▼** to select [SIGNAL NAME CHANGE].
- 5) Press the <ENTER> button.
  - The [SIGNAL NAME CHANGE] screen is displayed.
- 6) Press **▲▼◀▶** to select the text, and press the <ENTER> button to enter the text.
- 7) After the name is changed, press **▲▼◀▶** to select [OK], and press the <ENTER> button.
  - The registration is completed and the [REGISTERED SIGNAL SETUP] screen returns.
  - When pressing **▲▼◀▶** to select [CANCEL] and pressing the <ENTER> button, the changed signal name will not be registered and an automatically registered signal name will be used.

### Deleting the registered signal

Registered signals can be deleted.

- 1) Press **▲▼◀▶** to select the signal to delete.

- 2) Press the <DEFAULT> button on the remote control.
  - The [REGISTERED SIGNAL DELETE] screen is displayed.
  - To cancel the deletion, press the <MENU> button to return to the [REGISTERED SIGNAL LIST] screen.
- 3) Press the <ENTER> button.
  - The selected signal will be deleted.

**Note**

- A registered signal can also be deleted from [REGISTERED SIGNAL DELETE] on the [REGISTERED SIGNAL SETUP] screen.

**Protecting the registered signal**

- 1) Press ▲▼◀▶ to select the signal to protect.
- 2) Press the <ENTER> button.
  - The [REGISTERED SIGNAL STATUS] screen is displayed.
- 3) Press the <ENTER> button.
  - The [REGISTERED SIGNAL SETUP] screen is displayed.
- 4) Press ▲▼ to select [LOCK].
- 5) Press ◀▶ to switch the item.
  - The items will switch each time you press the button.

[OFF]	The signal is not protected.
[ON]	The signal is protected.

**Note**

- When [LOCK] is set to [ON], signal deletion, image adjustment, and automatic setup are not available. To perform these operations, set [LOCK] to [OFF].
- A signal can be registered to the sub memory even if it is protected.
- Even a protected signal will be deleted if [INITIALIZE] is executed.

**Expanding signal lock-in range**

- 1) Press ▲▼◀▶ to select the signal to set.
- 2) Press the <ENTER> button.
  - The [REGISTERED SIGNAL STATUS] screen is displayed.
- 3) Press the <ENTER> button.
  - The [REGISTERED SIGNAL SETUP] screen is displayed.
- 4) Press ▲▼ to select [LOCK-IN RANGE].
- 5) Press ◀▶ to switch the item.
  - The items will switch each time you press the button.

[NARROW]	Select in most cases.
[WIDE]	Widens the lock-in range.

**Note**

- Switch the range that determines that a signal to be input is the same signal that is already registered.
- To prioritize the determination that it is the same signal that is already registered, set to the [WIDE] setting.
- Use in cases such as when the synchronizing frequency of a signal to be input has changed slightly, or multiple signal lists are registered.
- Can only be used when a signal is input from the <RGB 1 IN> terminal, <RGB 2 IN> terminal, <DVI-D IN> terminal, <HDMI IN> terminal, or <DIGITAL LINK/LAN> terminal.
- When [WIDE] is set, the image may appear distorted because a signal is determined to be the same signal even if a synchronizing frequency changes slightly.
- When a signal to be input corresponds to multiple signals set in [WIDE], a registered signal with a high memory number receives priority. Example: a signal to be input that corresponds to memory numbers A2, A4, and B1 will be determined to be B1.
- When a registration signal is deleted, the settings are also deleted.
- In an environment where multiple types of signals are input to the same terminal, signals are sometimes not determined correctly when the setting is set to [WIDE].

## Sub memory

The projector has a sub memory function that can register the multiple image adjustment data, even if it is recognized as the same signal by the frequency or format of the synchronization signal source.

Use this function when you need to adjust the picture quality such as switching of the aspect ratio or white balance by the same synchronization signal source. The sub memory includes all the data that can be adjusted for each signal, such as the screen aspect ratio and data adjusted in the [PICTURE] item ([CONTRAST], [BRIGHTNESS], etc.).

### Registering to the sub memory

- 1) **Press ◀▶ on the normal screen (when the menu is not displayed).**
  - The sub memory registration screen is displayed if the sub memory is not registered. Proceed to Step 3).
  - A list of sub memories registered to the signal currently input is displayed.
  - By selecting [SUB MEMORY] in the [PROJECTOR SETUP] menu → [FUNCTION BUTTON], the <FUNCTION> button on the remote control can be used instead of ◀▶.
- 2) **Press ▲▼◀▶ to select the sub memory number to register in [SUB MEMORY LIST].**
- 3) **Press the <ENTER> button.**
  - The [SIGNAL NAME CHANGE] screen is displayed.
- 4) **Press ▲▼◀▶ to select [OK], and press the <ENTER> button.**
  - To rename the registered signal, follow the procedure in Steps 6) and 7) in "Renaming the registered signal" (➔ page 127).

### Switching to the sub memory

- 1) **Press ◀▶ on the normal screen (when the menu is not displayed).**
  - A list of sub memories registered to the signal currently input is displayed.
- 2) **Press ▲▼◀▶ to select the signal to switch in [SUB MEMORY LIST].**
- 3) **Press the <ENTER> button.**
  - This switches to the signal selected in Step 2).

### Deleting the sub memory

- 1) **Press ◀▶ on the normal screen (when the menu is not displayed).**
  - The [SUB MEMORY LIST] screen is displayed.
- 2) **Press ▲▼◀▶ to select the sub memory to delete, and press the <DEFAULT> button on the remote control.**
  - The [REGISTERED SIGNAL DELETE] screen is displayed.
  - To cancel the deletion, press the <MENU> button to return to the [SUB MEMORY LIST] screen.
- 3) **Press the <ENTER> button.**
  - The selected sub memory will be deleted.

## [SECURITY] menu

On the menu screen, select [SECURITY] from the main menu, and select an item from the sub-menu.

Refer to “Navigating through the menu” (➔ page 65) for the operation of the menu screen.

- When the projector is used for the first time  
Initial password: Press ▲▶▼◀▲▶▼◀ in order, and press the <ENTER> button.
- After selecting the item, press ▲▶▼◀ to set.



### Attention

- When you select the [SECURITY] menu and press the <ENTER> button, entering a password is required. Enter the preset password and then continue operations of the [SECURITY] menu.
- When the password has been changed previously, enter the changed password, and press the <ENTER> button.

### Note

- The entered password is displayed with \*marks on the screen.
- An error message is displayed on the screen when the entered password is incorrect. Re-enter the correct password.

## [SECURITY PASSWORD]

The [SECURITY PASSWORD] screen is displayed when the power is turned on. When the entered password is incorrect, the operation will be restricted to the power standby <⏻> button, the <SHUTTER> button, and the <LENS> (<FOCUS>, <ZOOM>, and <SHIFT>) buttons.

1) Press ▲▼ to select [SECURITY PASSWORD].

2) Press ◀▶ to switch the item.

- The items will switch each time you press the button.

[OFF]	Disables the security password entry.
[ON]	Enables the security password entry.

### Note

- In the factory default setting of after [ALL USER DATA] in [INITIALIZE] (➔ page 123) is executed, the [SECURITY PASSWORD] setting is set to [OFF].
- Change the password periodically that is hard to guess.
- The security password is enabled after setting [SECURITY PASSWORD] to [ON] and turning the <MAIN POWER> switch to <OFF>.

## [SECURITY PASSWORD CHANGE]

Change the security password.

1) Press ▲▼ to select [SECURITY PASSWORD CHANGE].

2) Press the <ENTER> button.

- The [SECURITY PASSWORD CHANGE] screen is displayed.

3) Press ▲▶▼◀ and the number (<0> - <9>) buttons to set the password.

- Up to eight button operations can be set.

4) Press the <ENTER> button.

5) Re-enter the password for the confirmation.

6) Press the <ENTER> button.

### Note

- The entered password is displayed with \*marks on the screen.
- An error message is displayed on the screen when the entered password is incorrect. Re-enter the correct password.

**[DISPLAY SETTING]**

Overlap the security message (text or image) over the projecting image.

1) Press ▲▼ to select [DISPLAY SETTING].

2) Press ◀▶ to switch the item.

- The items will switch each time you press the button.

[OFF]	The text display is disabled.
[TEXT]	The text display is enabled.
[USER LOGO]	Displays the image registered by the user.

**Note**

- To create/register the [USER LOGO] image, use "Logo Transfer Software" included in the supplied CD-ROM.

**[TEXT CHANGE]**

Change the text displayed when the text display is enabled by selecting [TEXT] in [DISPLAY SETTING].

1) Press ▲▼ to select [TEXT CHANGE].

2) Press the <ENTER> button.

- The [TEXT CHANGE] screen is displayed.

3) Press ▲▼◀▶ to select the text, and press the <ENTER> button to enter the text.

4) Press ▲▼◀▶ to select [OK], and press the <ENTER> button.

- The text is changed.

**[CONTROL DEVICE SETUP]**

Enable/disable the button operations on the control panel and the remote control.

1) Press ▲▼ to select [CONTROL DEVICE SETUP].

2) Press the <ENTER> button.

- The [CONTROL DEVICE SETUP] screen is displayed.

3) Press ▲▼ to select [CONTROL PANEL] or [REMOTE CONTROL].

[CONTROL PANEL]	You can set the limitation on the control from the control panel.
[REMOTE CONTROL]	You can set the limitation on the control from the remote control.

4) Press the <ENTER> button.

- The [CONTROL PANEL] screen or the [REMOTE CONTROL] screen is displayed.

5) Press ▲▼ to select [CONTROL PANEL] or [REMOTE CONTROL].

6) Press ◀▶ to switch the item.

- You can set the operation restriction from the control panel or the remote control.

[ENABLE]	Enables all button operations.
[DISABLE]	Disables all button operations.
[USER]	Operation of all buttons can be enabled/disabled separately. Refer to "Enabling/disabling any button" (➔ page 131) for details.

7) Press ▲▼ to select [APPLY], and press the <ENTER> button.

- The confirmation screen is displayed.

8) Press ◀▶ to select [OK], and press the <ENTER> button.

**Enabling/disabling any button**

1) Press ▲▼ to select [CONTROL DEVICE SETUP].

- 2) Press the <ENTER> button.
  - The [CONTROL DEVICE SETUP] screen is displayed.
- 3) Press ▲▼ to select [CONTROL PANEL] or [REMOTE CONTROL].
- 4) Press the <ENTER> button.
- 5) Press ▲▼ to select [CONTROL PANEL] or [REMOTE CONTROL].
- 6) Press ◀▶ to switch [USER].
- 7) Press ▲▼ to select the button item to set.
  - When [INPUT SELECT BUTTON] is selected, press the <ENTER> button, and then press ▲▼ to select the button to set.

	Buttons that can be set	
	[CONTROL PANEL]	[REMOTE CONTROL]
[POWER BUTTON]	Power standby <⏻> button, power on < > button	
[INPUT SELECT BUTTON]	<VIDEO> button, <RGB1/RGB2> button, or <RGB1/2> button, <DVI-D> button, <HDMI> button, <DIGITAL LINK> button, and <SDI> button *1	
[MENU BUTTON]	<MENU> button	
[LENS BUTTON]	<LENS> button	Lens (<FOCUS>, <ZOOM>, <SHIFT>) button
[AUTO SETUP BUTTON]	<AUTO SETUP> button	
[SHUTTER BUTTON]	<SHUTTER> button	
[ON SCREEN BUTTON]	—	<ON SCREEN> button
[OTHER BUTTON]	▲▼◀▶, <ENTER> button	Buttons not listed above

\*1 Only for PT-DZ870E

- 8) Press ◀▶ to switch the item.

[ENABLE]	Enables button operations.
[DISABLE]	Disables button operations.

- The following items are available only when [RGB1/2 BUTTON] of [INPUT SELECT BUTTON] is selected.

[TOGGLE]	Switches between RGB1 and RGB2 when the button is operated.
[RGB1]	Fixes to RGB1.
[RGB2]	Fixes to RGB2.
[DISABLE]	Disables button operations.

- When [INPUT SELECT BUTTON] is selected in Step 7), and after the item is switched, press the <MENU> button to return to the [CONTROL PANEL] screen or the [REMOTE CONTROL] screen.

- 9) Press ▲▼ to select [APPLY], and press the <ENTER> button.

- The confirmation screen is displayed.

- 10) Press ◀▶ to select [OK], and press the <ENTER> button.

### Note

- When a button operation is performed on the device set to [DISABLE], the [CONTROL DEVICE PASSWORD] screen is displayed. Enter the control device password.
- The [CONTROL DEVICE PASSWORD] screen will disappear when there is no operation for approx. 10 seconds.
- If the operations of both [CONTROL PANEL] and [REMOTE CONTROL] are set to [DISABLE], the projector cannot be turned off (cannot enter standby).
- When the setting has completed, the menu screen will disappear. To operate continuously, press the <MENU> button to display the main menu.
- Even when button operation on the remote control is disabled, operation of the <ID SET> button on the remote control is enabled.



## [CONTROL DEVICE PASSWORD CHANGE]

---

The control device password can be changed.

- 1) Press ▲▼ to select [CONTROL DEVICE PASSWORD CHANGE].
- 2) Press the <ENTER> button.
  - The [CONTROL DEVICE PASSWORD CHANGE] screen is displayed.
- 3) Press ▲▼◀▶ to select the text, and press the <ENTER> button to enter the text.
- 4) Press ▲▼◀▶ to select [OK], and press the <ENTER> button.
  - To cancel, select [CANCEL].

### **Attention**

---

---

- The initial password is "AAAA" by the factory default or when [ALL USER DATA] in [INITIALIZE] (► page 123) is executed.
- Change the password periodically that is hard to guess.

## [NETWORK] menu

On the menu screen, select [NETWORK] from the main menu, and select an item from the sub-menu.

Refer to “Navigating through the menu” (→ page 65) for the operation of the menu screen.

- After selecting the item, press ▲▼◀▶ to set.



### [DIGITAL LINK MODE]

Switch the communication method of the <DIGITAL LINK/LAN> terminal of the projector.

1) Press ▲▼ to select [DIGITAL LINK MODE].

2) Press ◀▶ to switch the item.

- The items will switch each time you press the button.

[AUTO]	Switches the communication method automatically to DIGITAL LINK or Ethernet.
[DIGITAL LINK]	Fixes the communication method to DIGITAL LINK.
[ETHERNET]	Fixes the communication method to Ethernet.

### Possible communication modes

Setting		Communication possible		
		Image transmission	Ethernet	RS-232C
[AUTO]	For DIGITAL LINK	✓	✓	✓
	For Ethernet	—	✓	—
[DIGITAL LINK]		✓	✓	✓
[ETHERNET]		—	✓	—

✓: Communication possible

—: Communication not possible

### [DIGITAL LINK SETUP]

Set the communication method of DIGITAL LINK.

#### When the projector is connected directly via Ethernet

1) Press ▲▼ to select [DIGITAL LINK SETUP].

2) Press the <ENTER> button.

- The [DIGITAL LINK SETUP] screen is displayed.

3) Press ▲▼ to select [DUPLEX(ETHERNET)].

4) Press ◀▶ to switch the communication method.

- The items will switch each time you press the button.

[AUTONEGOTIATION]	The communication method is set automatically.
[100BaseTX-Full]	Full duplex communication method is set.
[100BaseTX-Half]	Half-duplex communication method is set.

5) Press ▲▼ to select [STORE].

6) Press the <ENTER> button.

7) When the confirmation screen is displayed, press ◀▶ to select [OK], and press the <ENTER> button.

### Note

- The projector does not support 10BaseT Full/Half.

### When the projector is connected to a twisted-pair-cable transmitter

- 1) Press ▲▼ to select [DIGITAL LINK SETUP].
- 2) Press the <ENTER> button.
  - The [DIGITAL LINK SETUP] screen is displayed.
- 3) Press ▲▼ to select [DUPLX(DIGITAL LINK)].
- 4) Press ◀▶ to switch the communication method.
  - The items will switch each time you press the button.

[100BaseTX-Full]	Full duplex communication method is set.
[100BaseTX-Half]	Half-duplex communication method is set.
[AUTONEGOTIATION]	The communication method is set automatically.

- 5) Press ▲▼ to select [STORE].
- 6) Press the <ENTER> button.
- 7) When the confirmation screen is displayed, press ◀▶ to select [OK], and press the <ENTER> button.

### [DIGITAL LINK STATUS]

Display DIGITAL LINK connection environment.

- 1) Press ▲▼ to select [DIGITAL LINK STATUS].
- 2) Press the <ENTER> button.
  - The [DIGITAL LINK STATUS] screen is displayed.

[LINK STATUS]	Either [NO LINK], [DIGITAL LINK], or [ETHERNET] is displayed.
[HDCP STATUS]	Either [NO SIGNAL], [OFF], or [ON] is displayed.
[SIGNAL QUALITY]	<p>[SIGNAL QUALITY] is a numerical value of the amount of error, and the display color changes to green, yellow, or red depending on that value. Check the signal quality level while receiving a signal from the twisted-pair-cable transmitter.</p> <ul style="list-style-type: none"> <li>• MAX/MIN: Maximum/minimum value of the amount of error.</li> <li>• Green (–12 dB or lower) → Normal signal quality level.</li> <li>• Yellow (–11 to –8 dB) → Warning level where there is the possibility of noise introduced on the screen.</li> <li>• Red (–7 dB or higher) → Abnormal level where synchronization may be interrupted, or a signal may not be received.</li> </ul>

### [NETWORK SETUP]

Perform the initial setting of the network before using the network function.

- 1) Press ▲▼ to select [NETWORK SETUP].
- 2) Press the <ENTER> button.
  - The [NETWORK SETUP] screen is displayed.
- 3) Press ▲▼ to select an item, and change the settings according to the operation instructions of the menu.

[PROJECTOR NAME]	Change the setting when using a DHCP server.
[DHCP]	Set to [ON] when obtaining an IP address automatically using a DHCP server. Set to [OFF] when not using a DHCP server.
[IP ADDRESS]	Enter the IP address when not using a DHCP server.
[SUBNET MASK]	Enter the subnet mask when not using a DHCP server.
[DEFAULT GATEWAY]	Enter the default gateway address when not using a DHCP server.
[STORE]	Save the current network settings.

- 4) Press ▲▼ to select [STORE], and press the <ENTER> button.
- 5) When the confirmation screen is displayed, press ◀▶ to select [OK], and press the <ENTER> button.

**Note**

- When using a DHCP server, confirm that the DHCP server is running.
- Consult your network administrator regarding the IP address, subnet mask, and default gateway.

**[NETWORK CONTROL]**

Set up the control method of the network.

- 1) Press ▲▼ to select [NETWORK CONTROL].
- 2) Press the <ENTER> button.
  - The [NETWORK CONTROL] screen is displayed.
- 3) Press ▲▼ to select an item, and press ◀▶ to change the setting.

[WEB CONTROL]	Set to [ON] to control with the web browser.
[PJLink CONTROL]	Set to [ON] to control with the PJLink protocol.
[COMMAND CONTROL]	Set to [ON] to control with the <SERIAL IN>/<SERIAL OUT> terminal control command format (➡ page 175). Refer to “Control commands via LAN” (➡ page 170).
[COMMAND PORT]	Set the port number used for command control.
[CRESTRON RoomView]	Set to [ON] to control with RoomView of Crestron Electronics, Inc.
[AMX D.D.]	Set to [ON] to control with the controller of AMX Corporation. Setting this function to [ON] enables detection through “AMX Device Discovery”. For details, refer to the website of AMX Corporation. URL <a href="http://www.amx.com/">http://www.amx.com/</a>
[EXTRON XTP]	Set to [ON] when connecting the “XTP transmitter” of Extron Electronics to the <DIGITAL LINK/LAN> terminal. The [EXTRON XTP] setting must be set to [OFF] when connecting the optional Digital Interface Box (Model No.: ET-YFB100G). For details of the “XTP transmitter”, refer to the website of Extron Electronics. URL <a href="http://www.extron.com/">http://www.extron.com/</a>
[STORE]	Save the current network control settings.

- 4) Press ▲▼ to select [STORE], and press the <ENTER> button.
- 5) When the confirmation screen is displayed, press ◀▶ to select [OK], and press the <ENTER> button.

**[NETWORK STATUS]**

Display the status of the projector network.

- 1) Press ▲▼ to select [NETWORK STATUS].
- 2) Press the <ENTER> button.
  - The [NETWORK STATUS] screen is displayed.

**[DIGITAL INTERFACE BOX]**

When the optional Digital Interface Box (Model No.: ET-YFB100G) is connected to the <DIGITAL LINK/LAN> terminal, the main menu of ET-YFB100G is displayed. Refer to the Operating Instructions of ET-YFB100G for details.

**Note**

- When [EXTRON XTP] is set to [ON], [DIGITAL INTERFACE BOX] cannot be selected.
- The operation guidance for the “RETURN” button is displayed on the menu screen of the Digital Interface Box. The projector does not have the “RETURN” button, but same operation is available with the <MENU> button.

**[Art-Net SETUP]**

Settings to use the Art-Net function is executed.

- 1) Press ▲▼ to select [Art-Net SETUP].
- 2) Press the <ENTER> button.
  - The [Art-Net SETUP] screen is displayed.

3) Press ▲▼ to select an item.

[Art-Net]	Sets to [ON] when the Art-Net function is used. Sets to [OFF] when the Art-Net function is not used.
[PORT ADDRESS]	Inputs a port address that the projector processes Art-Net.
[START ADDRESS]	Inputs a start address that the projector processes Art-Net.

4) Press ◀▶ to switch the setting.

5) Press ▲▼ to select [STORE], and press the <ENTER> button.

6) When the confirmation screen is displayed, press ◀▶ to select [OK], and press the <ENTER> button.

## Network connections

The projector has a network function, and the following operations are available from the computer using the web control.

- Setting and adjustment of the projector
- Display of the projector status
- Sending of E-mail messages when there is a problem with the projector

The projector supports “Crestron RoomView”, and the following application software of Crestron Electronics, Inc. can be used.

- RoomView Express
- Fusion RV
- RoomView Server Edition

### Attention

- When a LAN cable is directly connected to the projector, the network connection must be made indoors.

### Note

- “Crestron RoomView” is a system of Crestron Electronics, Inc. that collectively manages and controls devices on multiple systems connected to a network using a computer.
- For details of “Crestron RoomView”, refer to the website of Crestron Electronics, Inc. (English only)  
URL <http://www.crestron.com>  
To download “RoomView Express”, go to the following website of Crestron Electronics, Inc. (English only)  
URL <http://www.crestron.com/getroomview>
- A LAN cable is required to use the network function.

### ■ Example of a normal network connection

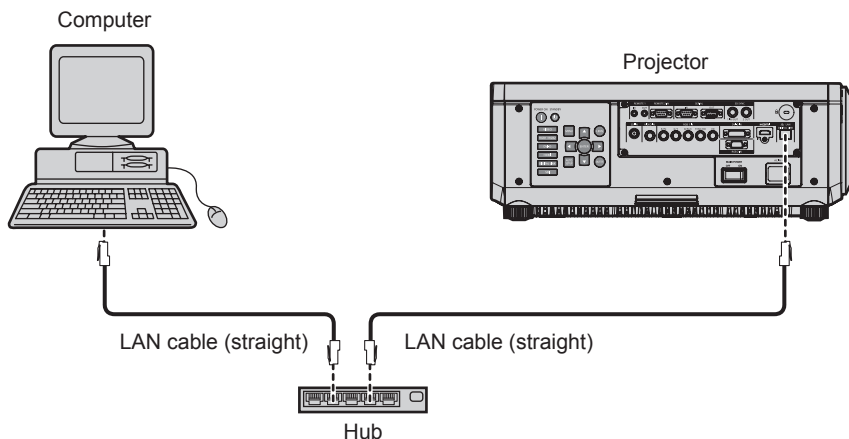

- A web browser is required to use this function. Confirm that the web browser can be used beforehand.  
Compatible OS: Windows XP/Windows Vista/Windows 7/Windows 8, Mac OS X v10.4/v10.5/v10.6/v10.7/v10.8  
Compatible browser: Internet Explorer 7.0/8.0/9.0/10.0, Safari 4.0/5.0/6.0 (Mac OS)
- Communication with an E-mail server is required to use the E-mail function. Confirm that the E-mail can be used beforehand.
- Use a LAN cable that is compatible with category 5 or higher.
- Use a LAN cable of 100 m (328'1") or shorter.

## Connecting to a twisted-pair-cable transmitter

The projector has a function that can receive Ethernet signals from a twisted-pair-cable transmitter together with video and audio signals via a LAN cable. Connect a LAN cable to the <DIGITAL LINK/LAN> terminal of the projector. (➔ pages 18, 28)

## ■ Example of network connections via a twisted-pair-cable transmitter

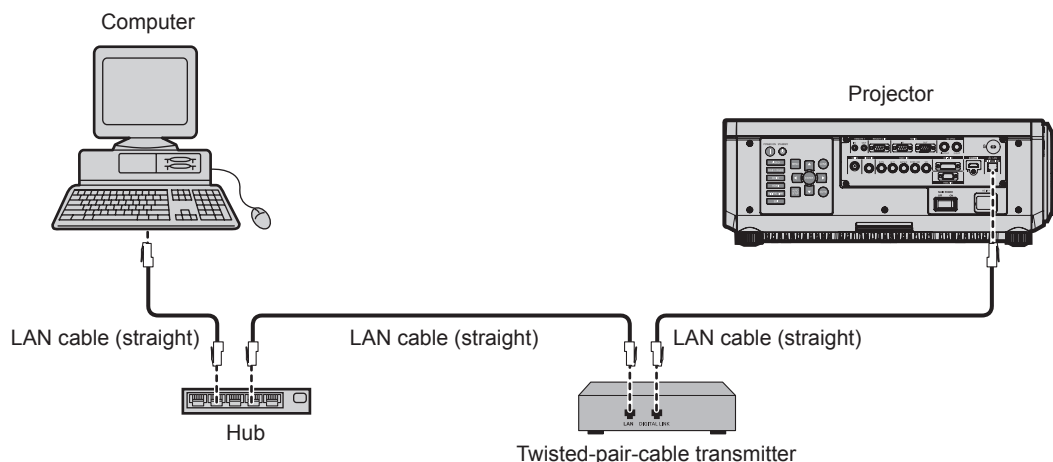

- For the LAN cable between a twisted-pair-cable transmitter and the projector, use a cable that meets the following criteria:
  - Compatible with CAT5e or higher
  - Shielded type (including connectors)
  - Straight-through
  - Single wire
- The maximum transmission distance between the twisted-pair-cable transmitter and the projector is 100 m (328'1"). If this distance is exceeded, image may be disrupted and may cause a malfunction in LAN communication.
- When laying cables between a twisted-pair-cable transmitter and the projector, check that cable characteristics are compatible with CAT5e or higher using tools such as a cable tester or cable analyzer.
  - When using a relay connector midway, include it in the measurement.
- Do not use a hub between a twisted-pair-cable transmitter and the projector.
- Do not pull cables forcefully. Also, do not bend or fold cables unnecessarily.
- To reduce the effects of noise as much as possible, stretch out the cables between the twisted-pair-cable transmitter and the projector without any loops.
- Lay the cables between a twisted-pair-cable transmitter and the projector away from other cables, particularly power cables.
- When installing multiple cables, run them side by side along the shortest distance possible without bundling them together.
- After laying the cables, confirm that the value of [SIGNAL QUALITY] in the [NETWORK] menu → [DIGITAL LINK STATUS] is displayed in green (indicates normal quality). (► page 135)
- For twisted-pair-cable transmitter of other manufacturers of which the operation has been verified with the DIGITAL LINK compatible projector, refer to Panasonic website (<http://panasonic.net/avc/projector/>). Note that the verification for devices of other manufacturers has been made for the items set by Panasonic Corporation, and not all the operations have been verified. For operation or performance problems caused by the devices of other manufacturers, contact the respective manufacturers.

## Accessing from the web browser

- 1) Start up the web browser on the computer.
- 2) Enter the IP address set on the projector into the URL entry field of the web browser.
- 3) Enter the user name and the password.
  - The factory default setting of the user name is user1 (user rights)/admin1 (administrator rights) and the password is panasonic (lower case).

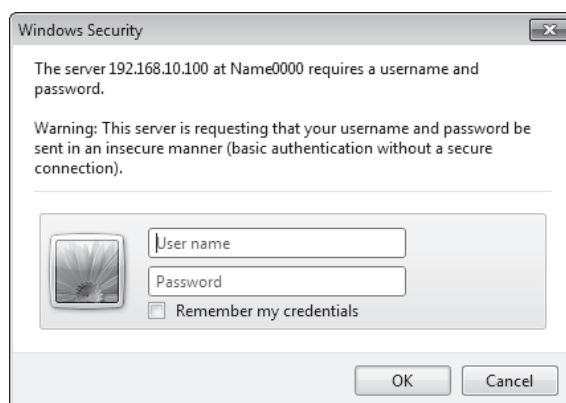

4) Click OK.

- The [Projector status] page is displayed.

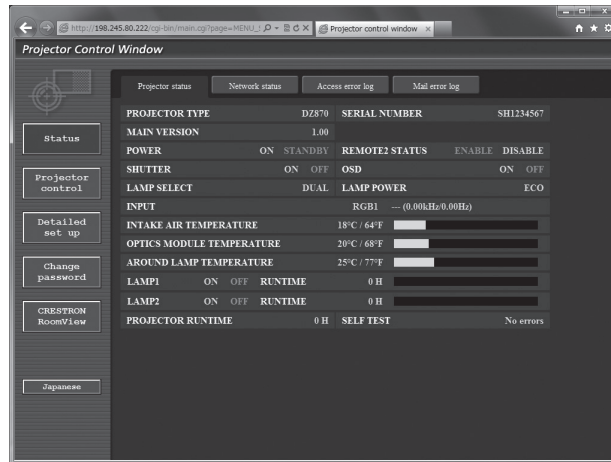

Note

- If you use a web browser to control the projector, set [WEB CONTROL] to [ON] in [NETWORK CONTROL] (➔ page 136).
- Do not perform setting or control simultaneously by starting up multiple web browsers. Do not set or control the projector from multiple computers.
- Change the password first. (➔ page 152)
- The administrator rights allow use of all functions. The user rights allow use of [Projector status] (➔ page 140), confirmation of the error information page (➔ page 141), [Network status] (➔ page 142), [Basic control] (➔ page 143), and [Change password] (➔ page 152) only.
- Access will be locked for few minutes when an incorrect password is entered three times consecutively.
- Some items on the projector setting page use the Javascript function of the web browser. The projector may not be able to be controlled properly if it is set with a browser that does not have this function enabled.
- If the screen for the web control is not displayed, consult your network administrator.
- While updating the screen for the web control, the screen may become white for a moment, but it is not a malfunction.

Descriptions of items

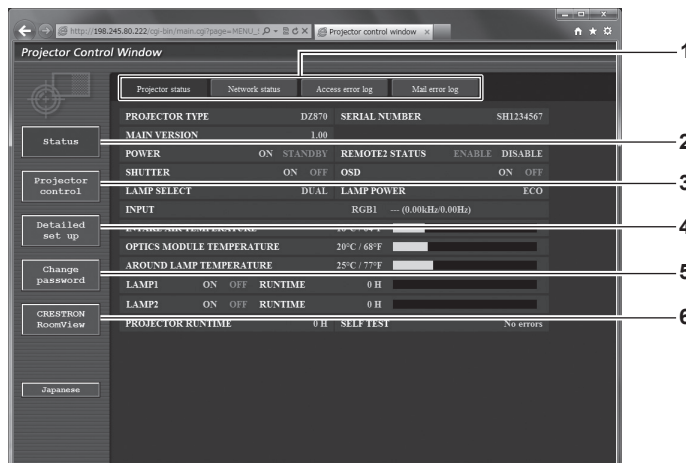

- |  |  |
|--|--|
| <p>1 <b>Page tab</b><br/>Switches pages by clicking this item.</p> <p>2 <b>[Status]</b><br/>The status of the projector is displayed by clicking this item.</p> <p>3 <b>[Projector control]</b><br/>The [Projector control] page is displayed by clicking this item.</p> | <p>4 <b>[Detailed set up]</b><br/>The [Detailed set up] page is displayed by clicking this item.</p> <p>5 <b>[Change password]</b><br/>The [Change password] page is displayed by clicking this item.</p> <p>6 <b>[CRESTRON RoomView]</b><br/>The control page of RoomView is displayed by clicking this item.</p> |
|--|--|

[Projector status] page

Click [Status] → [Projector status].

Display the status of the projector for the following items.

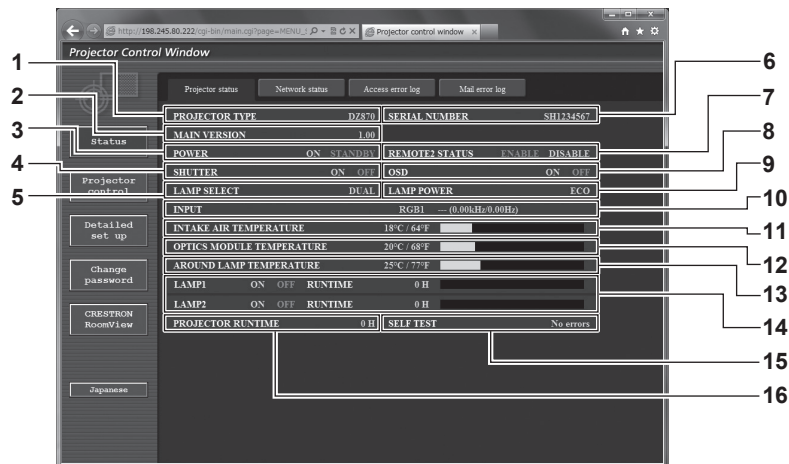

- |   |   |
|---|---|
| <p>1 <b>[PROJECTOR TYPE]</b><br/>Displays the type of the projector.</p> <p>2 <b>[MAIN VERSION]</b><br/>Displays the firmware version of the projector.</p> <p>3 <b>[POWER]</b><br/>Displays the status of the power.</p> <p>4 <b>[SHUTTER]</b><br/>Displays the status of the shutter (ON: closed, OFF: open).</p> <p>5 <b>[LAMP SELECT]</b><br/>Displays the setting status of [LAMP SELECT] (➡ page 109).</p> <p>6 <b>[SERIAL NUMBER]</b><br/>Displays the serial number of the projector.</p> <p>7 <b>[REMOTE2 STATUS]</b><br/>Displays the control status of the &lt;REMOTE 2 IN&gt; terminal.</p> <p>8 <b>[OSD]</b><br/>Displays the status of the on-screen display.</p> | <p>9 <b>[LAMP POWER]</b><br/>Displays the setting status of [LAMP POWER] (➡ page 111).</p> <p>10 <b>[INPUT]</b><br/>Displays the status of the selected input.</p> <p>11 <b>[INTAKE AIR TEMPERATURE]</b><br/>Displays the status of the air intake temperature of the projector.</p> <p>12 <b>[OPTICS MODULE TEMPERATURE]</b><br/>Displays the status of the internal temperature of the projector.</p> <p>13 <b>[AROUND LAMP TEMPERATURE]</b><br/>Displays the status of the temperature around the lamp of the projector.</p> <p>14 <b>[LAMP1], [LAMP2], [RUNTIME]</b><br/>Displays the status and the runtime (converted value) of the lamp.</p> <p>15 <b>[SELF TEST]</b><br/>Displays the self-diagnosis information.</p> <p>16 <b>[PROJECTOR RUNTIME]</b><br/>Displays the runtime of the projector.</p> |
|---|---|



Error information page

When [Error (Detail)] or [Warning (Detail)] is displayed in the self-diagnosis display of the [Projector status] screen, click it to display the error/warning details.

- The projector may go into the standby status to protect the projector depending on the contents of the error.

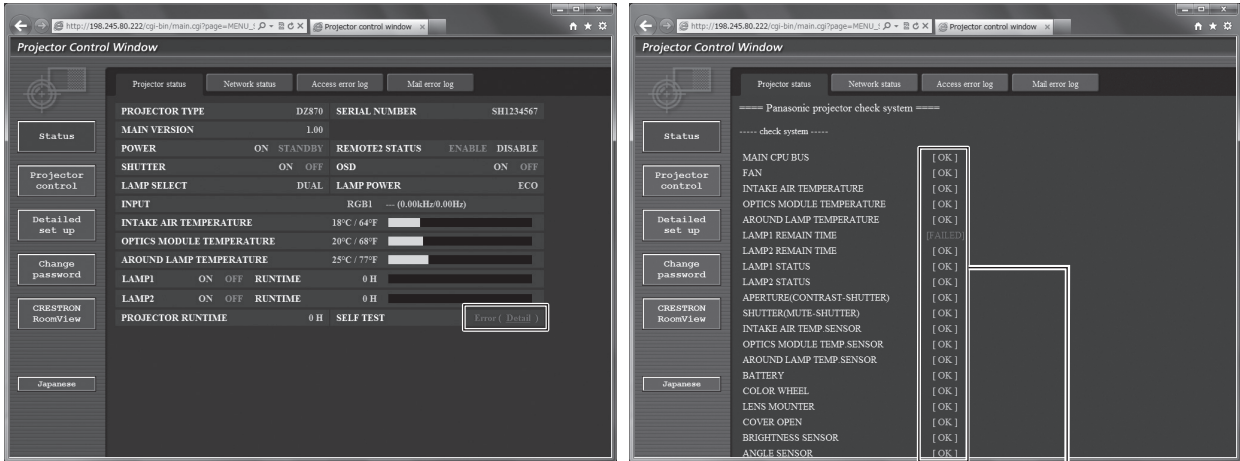

1

1 Self-diagnosis result display

Displays the item check results.

**[OK]:**

Indicates that operation is normal.

**[FAILED]:**

Indicates that there is a problem.

**[WARNING]:**

Indicates that there is a warning.

■ [FAILED] items

Parameter	Description
[MAIN CPU BUS]	There is a problem with the microcomputer circuitry. Consult your dealer.
[FAN]	There is a problem with the fan or the fan drive circuit. Consult your dealer.
[INTAKE AIR TEMPERATURE]	The air intake temperature is too high. The projector may be used in an environment where the temperature is high, such as near a heating appliance.
[OPTICS MODULE TEMPERATURE]	The temperature around the optics module inside the projector is high. The projector may be used in an environment where the temperature is high, such as near a heating appliance.
[AROUND LAMP TEMPERATURE]	The temperature around the lamp is high. The air exhaust port may be blocked.
[LAMP1 REMAIN TIME]	The runtime of the lamp has exceeded the specified time, and it is time to replace the lamp.
[LAMP2 REMAIN TIME]	
[LAMP1 STATUS]	The lamp has failed to turn on. Wait a while until the luminous lamp cools off, and then turn on the power.
[LAMP2 STATUS]	
[APERTURE(CONTRAST-SHUTTER)]	There is a problem in the contrast shutter circuit for dynamic iris. Consult your dealer.
[SHUTTER(MUTE-SHUTTER)]	There is a problem with the shutter circuitry. Consult your dealer.
[INTAKE AIR TEMP.SENSOR]	There is a problem with the sensor used to detect intake temperature. Consult your dealer.
[OPTICS MODULE TEMP.SENSOR]	There is a problem with the sensor used to detect temperature inside the projector. Consult your dealer.
[AROUND LAMP TEMP.SENSOR]	There is a problem with the sensor used to detect exhaust air temperature. Consult your dealer.
[BATTERY]	Battery replacement is required. Consult your dealer.
[COLOR WHEEL]	There is a problem with the color wheel or the color wheel drive circuit. Consult your dealer.
[LENS MOUNTER]	There is a problem in the lens mouter. Consult your dealer.
[COVER OPEN]	Installation of the lamp unit cover is incomplete. Check the installation of the lamp unit cover. (▶ page 162)
[BRIGHTNESS SENSOR]	There is a problem with the luminance sensor. If problems persist even after switching on the power, consult your dealer.
[ANGLE SENSOR]	There is a problem with the sensor that detects angle. Consult your dealer.
[AIR FILTER CASE]	The air filter case is not attached. Check the attachment of the air filter unit. (▶ page 160)

Parameter	Description
[AIR FILTER]	There is too much dust accumulated in the air filter. Turn the <MAIN POWER> switch <OFF> (➔ page 57), and clean the air filter. (➔ page 160)

■ [WARNING] items

Parameter	Description
[AC POWER]	AC input voltage is weak. Use electric wiring that can sufficiently withstand the power consumption of the projector.
[LOW-TEMPERATURE]	The temperature around the optics module inside the projector is low. Projection cannot be started until the optics module becomes warm.
[HORIZONTAL TILT]	The projector is used tilting at an angle that exceeds 15° from the horizontal plane.
[LIGHT OUTPUT LIMIT]	The projector may be used in an environment where the temperature is high. The light output is reduced by approx. 20 % to protect the projector.

[Network status] page

Click [Status] → [Network status].

The current network setting status is displayed.

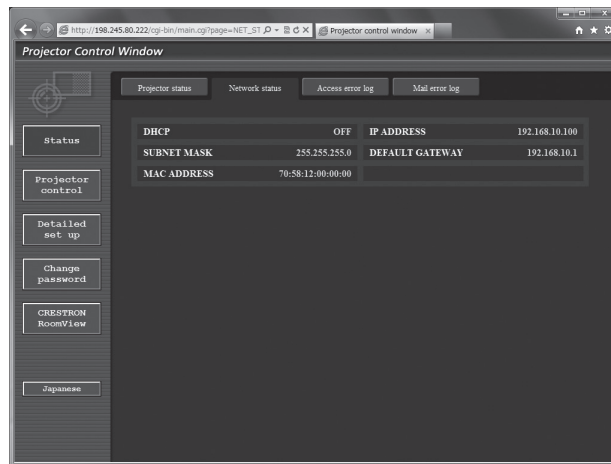

[Access error log] page

Click [Status] → [Access error log].

The error log on the web server is displayed such as access to the pages that do not exist or access with unauthorized user names or passwords.

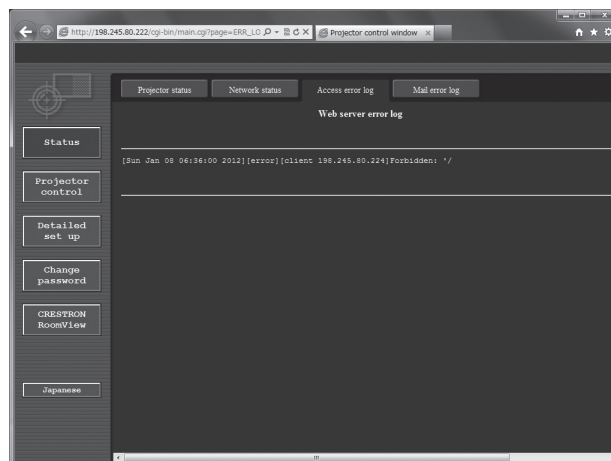

## [Mail error log] page

Click [Status] → [Mail error log].

Display E-mail error information if failed to send periodic E-mails.

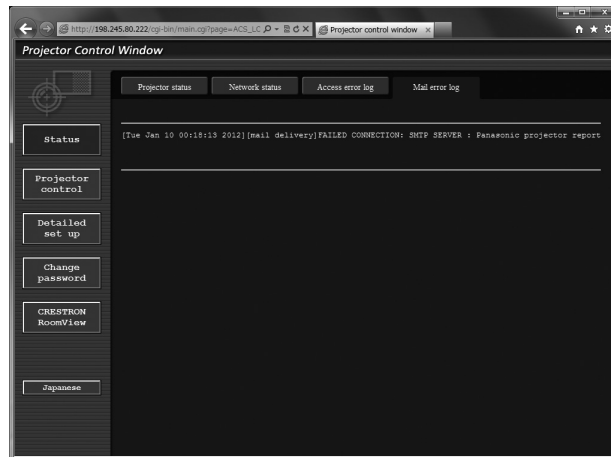

### Note

- [Access error log] and [Mail error log] display the recent few thousand accesses/requests. All information may not be displayed when many accesses/requests are made at one time.
- When [Access error log] and [Mail error log] exceeds a certain amount, older information is erased.
- Check [Access error log] and [Mail error log] periodically.

## [Basic control] page

Click [Projector control] → [Basic control].

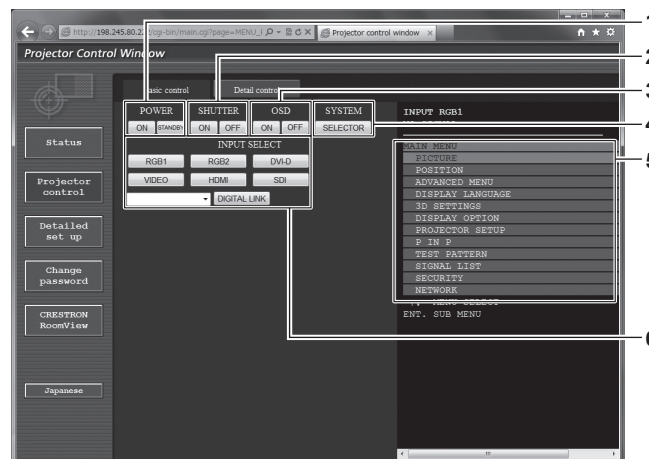

- [POWER]**  
Turns on/off the power.
- [SHUTTER]**  
Switches the setting whether to use the shutter function (closing/opening of the shutter).
- [OSD]**  
Switches on (display)/off (hide) the on-screen display function.
- [SYSTEM]**  
Switches the system method.
- On-screen display of the projector**  
Displays the same items as shown on the on-screen display of the projector. You can check or change the settings of the menus. It is displayed even if the on-screen display function is set to off (hide).
- [INPUT SELECT]**  
Switches the input signal.

[Detail control] page

Click [Projector control] → [Detail control].

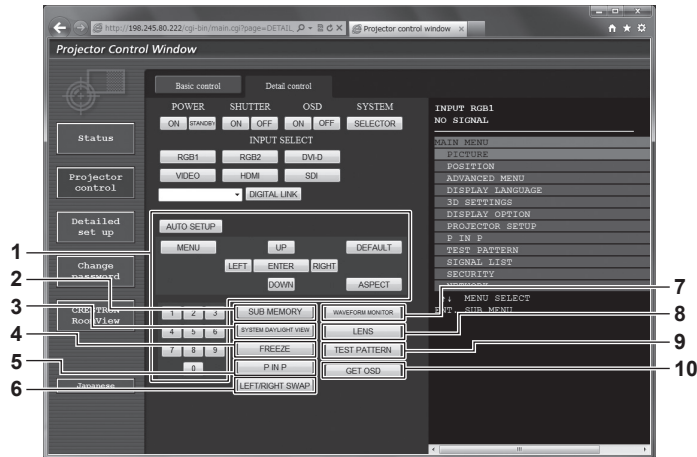

**1 Control of the projector**

The projector is controlled by clicking the buttons in the same way as the buttons on the remote control. After control, the on-screen display of the projector at the right of the control page is updated.

**2 [SUB MEMORY]**

Switches the sub memory.

**3 [SYSTEM DAYLIGHT VIEW]**

Switches to system daylight view settings.

**4 [FREEZE]**

Temporarily pauses the image.

**5 [P IN P]**

Switches the P IN P setting.

**6 [LEFT/RIGHT SWAP]**

Switches the flip horizontal settings.

**7 [WAVEFORM MONITOR]**

Displays the waveform of the input signal.

**8 [LENS]**

Adjusts the projection lens.

**9 [TEST PATTERN]**

Displays the test pattern.

**10 [GET OSD]**

Updates the on-screen display of the projector at the right of the control page.

**[Network config] page**

Click [Detailed set up] → [Network config].

- Click [Network config] to display the **[CAUTION!]** screen.
- The current settings are displayed by pressing the [Next] button.
- Click [Change] to display the setting change screen.

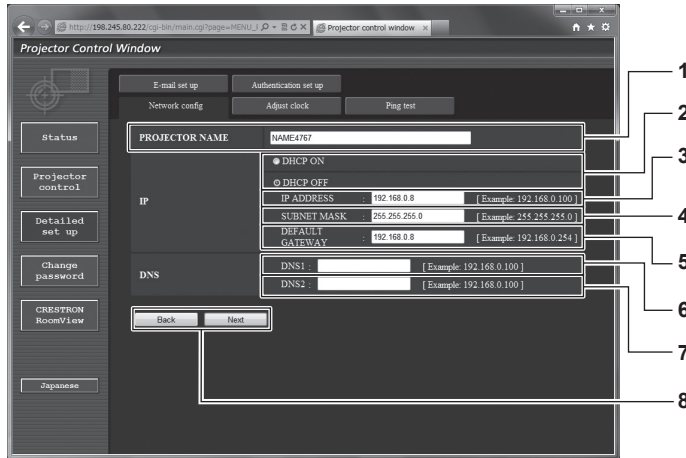

- |   |  |
|---|--|
| <p><b>1 [PROJECTOR NAME]</b><br/>Enter the name of the projector. Enter the host name if it is required when using a DHCP server etc.</p> <p><b>2 [DHCP ON], [DHCP OFF]</b><br/>To enable the DHCP client function, set to [DHCP ON].</p> <p><b>3 [IP ADDRESS]</b><br/>Enter the IP address when not using a DHCP server.</p> <p><b>4 [SUBNET MASK]</b><br/>Enter the subnet mask when not using a DHCP server.</p> <p><b>5 [DEFAULT GATEWAY]</b><br/>Enter the default gateway address when not using a DHCP server.</p> | <p><b>6 [DNS1]</b><br/>Enter the DNS1 server address.<br/>Permissible characters for the entry of DNS1 server address (primary):<br/>Numbers (0 - 9), period (.)<br/>(Example: 192.168.0.253)</p> <p><b>7 [DNS2]</b><br/>Enter the DNS2 server address.<br/>Available characters for the entry of DNS2 server address (secondary):<br/>Numbers (0 - 9), period (.)<br/>(Example: 192.168.0.254)</p> <p><b>8 [Back], [Next]</b><br/>Click the [Back] button to return to the original screen. The current settings are displayed by pressing the [Next] button. Click the [Submit] button to update the settings.</p> |
|---|--|

**Note**

- When you use the “Forward” and “Back” functions of your browser, a warning message “Page has Expired” may appear. In that case, click [Network config] again since the following operation will not be guaranteed.
- Changing LAN settings while connected to the LAN may cause the connection to cut out.

[Adjust clock] page

Click [Detailed set up] → [Adjust clock].

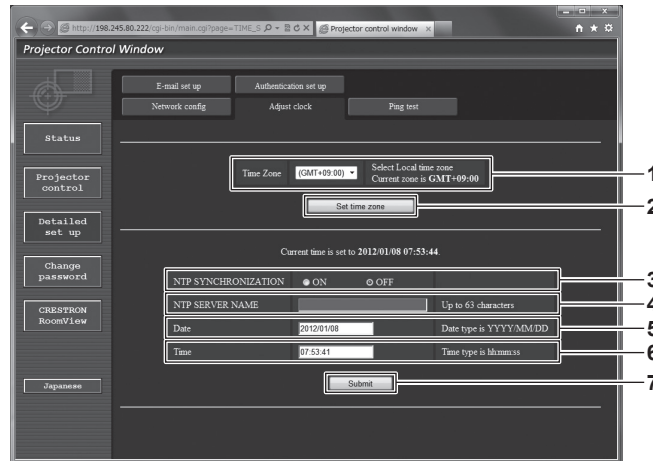

- |   |  |
|---|--|
| <p>1 <b>[Time Zone]</b><br/>Select the time zone.</p> <p>2 <b>[Set time zone]</b><br/>Updates the time zone setting.</p> <p>3 <b>[NTP SYNCHRONIZATION]</b><br/>Set to [ON] to adjust the date and time automatically.</p> <p>4 <b>[NTP SERVER NAME]</b><br/>Enter the IP address or server name of the NTP server when you set to adjust the date and time manually.<br/>(To enter the server name, the DNS server needs to be set up.)</p> | <p>5 <b>[Date]</b><br/>Enter the date to be changed.</p> <p>6 <b>[Time]</b><br/>Enter the time to be changed.</p> <p>7 <b>[Submit]</b><br/>Updates the date and time settings.</p> |
|---|--|

Note

- The replacement of the battery inside the projector is required when the time goes out of alignment right after correcting the time. Consult your dealer.

[Ping test] page

Check whether the network is connected to the E-mail server, POP server, DNS server, etc.

Click [Detailed set up] → [Ping test].

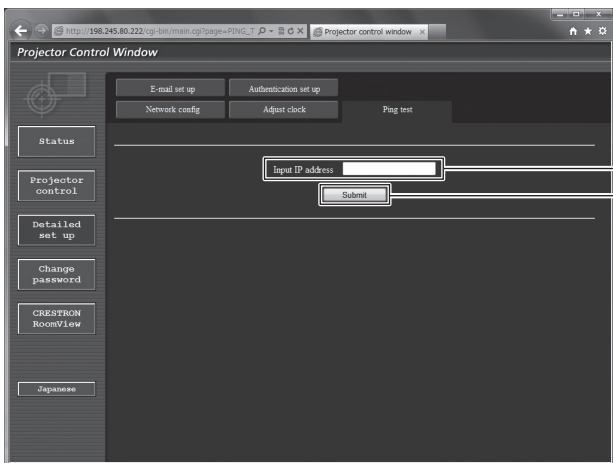

```
PING 192.168.10.218 (192.168.10.218): 56 data bytes
64 bytes from 192.168.10.218: seq=0 ttl=128 time=1.228 ms
64 bytes from 192.168.10.218: seq=1 ttl=128 time=0.942 ms
64 bytes from 192.168.10.218: seq=2 ttl=128 time=0.854 ms
64 bytes from 192.168.10.218: seq=3 ttl=128 time=0.962 ms

--- 192.168.10.218 ping statistics ---
4 packets transmitted, 4 packets received, 0% packet loss
round-trip min/avg/max = 0.854/0.998/1.228 ms
```

```
PING 192.168.10.217 (192.168.10.217): 56 data bytes

--- 192.168.10.217 ping statistics ---
4 packets transmitted, 0 packets received, 100% packet loss
```

- |  |  |
|--|--|
| <p>1 <b>[Input IP address]</b><br/>Enter the IP address of the server to be tested.</p> <p>2 <b>[Submit]</b><br/>Executes the connection test.</p> | <p>3 <b>Example of display when the connection has succeeded</b></p> <p>4 <b>Example of display when the connection has failed</b></p> |
|--|--|

**[E-mail set up] page**

When there is a problem or the runtime of a lamp reaches a set value, an E-mail can be sent to preset E-mail addresses (up to two addresses).

Click [Detailed set up] → [E-mail set up].

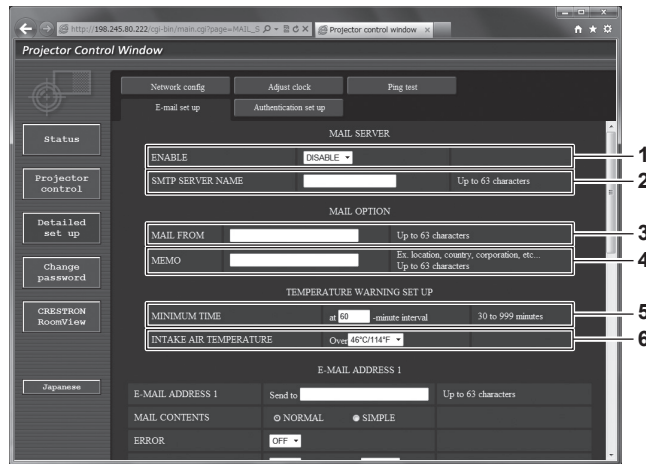

- |   |   |
|---|---|
| <p><b>1 [ENABLE]</b><br/>Select [ENABLE] to use the E-mail function.</p> <p><b>2 [SMTP SERVER NAME]</b><br/>Enter the IP address or the server name of the E-mail server (SMTP). To enter the server name, the DNS server needs to be set up.</p> <p><b>3 [MAIL FROM]</b><br/>Enter the E-mail address of the projector. (Up to 63 characters in single byte)</p> <p><b>4 [MEMO]</b><br/>Enter information such as the location of the projector that notifies the sender of the E-mail. (Up to 63 characters in single byte)</p> | <p><b>5 [MINIMUM TIME]</b><br/>Change the minimum interval for the temperature warning E-mail. The default value is 60 minutes. In this case, another E-mail will not be sent for 60 minutes after sending the temperature warning E-mail even if it reaches the warning temperature.</p> <p><b>6 [INTAKE AIR TEMPERATURE]</b><br/>Change the temperature setting for the temperature warning mail. A temperature warning E-mail is sent when the temperature exceeds this value.</p> |
|---|---|

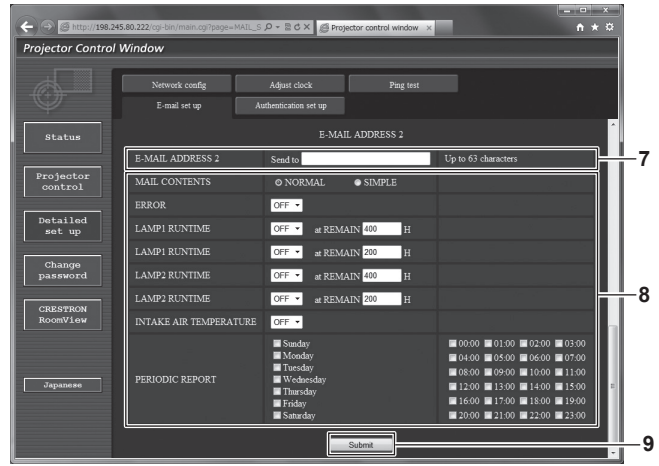
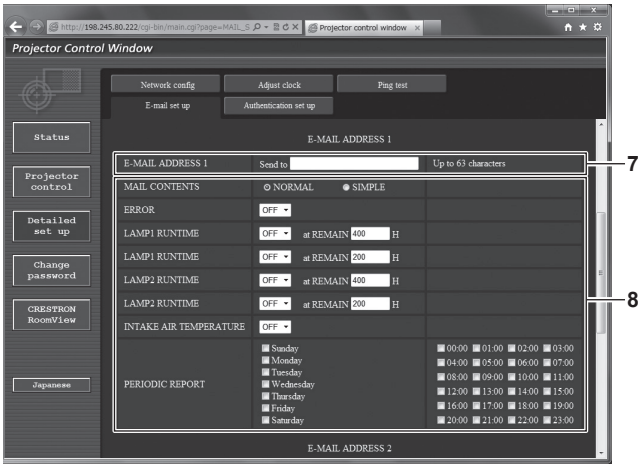

**7 [E-MAIL ADDRESS 1], [E-MAIL ADDRESS 2]**  
 Enter the E-mail address to be sent. Leave [E-MAIL ADDRESS 2] blank when two E-mail addresses are not to be used.

**8 Settings of the conditions to send E-mail**  
 Select the conditions to send E-mail.  
**[MAIL CONTENTS]:**  
 Select either [NORMAL] or [SIMPLE].  
**[ERROR]:**  
 Send an E-mail when an error occurred in the self-diagnosis.  
**[LAMP1 RUNTIME]:**  
 An E-mail message is sent when the remaining lamp on time for the lamp 1 has reached the value set at the right field.  
**[LAMP2 RUNTIME]:**  
 An E-mail message is sent when the remaining lamp on time for the lamp 2 has reached the value set at the right field.  
**[INTAKE AIR TEMPERATURE]:**  
 Send an E-mail when the air intake temperature has reached the value set at the above field.  
**[PERIODIC REPORT]:**  
 Place a check mark on this to send an E-mail periodically. It will be sent on the days and time with the check mark.

**9 [Submit]**  
 Update the settings.



**[Authentication set up] page**

Set the authentication items when POP authentication or SMTP authentication is necessary to send an E-mail.  
Click [Detailed set up] → [Authentication set up].

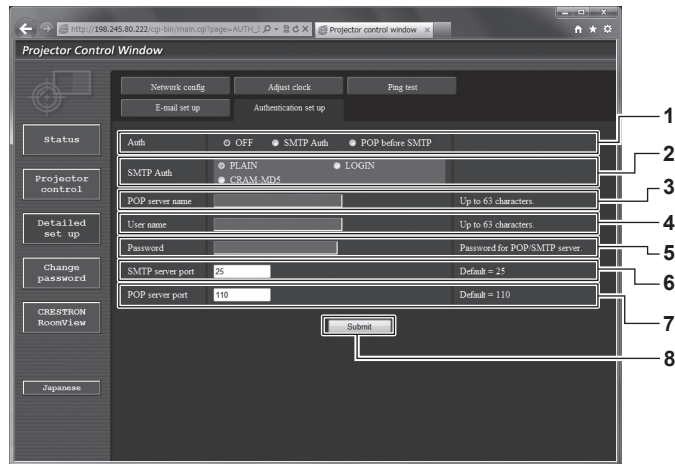

- |  |   |
|--|---|
| <p><b>1 [Auth]</b><br/>Select the authentication method specified by your Internet service provider.</p> <p><b>2 [SMTP Auth]</b><br/>Set when the SMTP authentication is selected.</p> <p><b>3 [POP server name]</b><br/>Enter the POP server name.<br/>Allowed characters:<br/>Alphanumerics (A - Z, a - z, 0 - 9)<br/>Minus sign (-) and period (.)</p> <p><b>4 [User name]</b><br/>Enter the user name for the POP server or the SMTP server.</p> | <p><b>5 [Password]</b><br/>Enter the password for the POP server or the SMTP server.</p> <p><b>6 [SMTP server port]</b><br/>Enter the port number of the SMTP server.<br/>(Normally 25)</p> <p><b>7 [POP server port]</b><br/>Enter the port number of the POP server.<br/>(Normally 110)</p> <p><b>8 [Submit]</b><br/>Update the settings.</p> |
|--|---|

## Contents of E-mail sent

## Example of E-mail sent when E-mail is set

The following E-mail is sent when the E-mail settings have been established.

```

=== Panasonic projector report(CONFIGURE) ===
Projector Type   : DZ870
Serial No       : SH1234567

----- E-mail setup data -----
TEMPERATURE WARNING SETUP
MINIMUM TIME           at [ 60] minutes interval
INTAKE AIR TEMPERATURE Over [ 46 degC / 114 degF ]

ERROR      [ OFF ]
LAMP1 RUNTIME      [ OFF ] at REMAIN [ 400] H
LAMP1 RUNTIME      [ OFF ] at REMAIN [ 200] H
LAMP2 RUNTIME      [ OFF ] at REMAIN [ 400] H
LAMP2 RUNTIME      [ OFF ] at REMAIN [ 200] H
INTAKE AIR TEMPERATURE      [ OFF ]
PERIODIC REPORT
Sunday [ OFF ] Monday [ OFF ] Tuesday [ OFF ] Wednesday [ OFF ]
Thursday [ OFF ] Friday [ OFF ] Saturday [ OFF ]

00:00 [ OFF ] 01:00 [ OFF ] 02:00 [ OFF ] 03:00 [ OFF ]
04:00 [ OFF ] 05:00 [ OFF ] 06:00 [ OFF ] 07:00 [ OFF ]
08:00 [ OFF ] 09:00 [ OFF ] 10:00 [ OFF ] 11:00 [ OFF ]
12:00 [ OFF ] 13:00 [ OFF ] 14:00 [ OFF ] 15:00 [ OFF ]
16:00 [ OFF ] 17:00 [ OFF ] 18:00 [ OFF ] 19:00 [ OFF ]
20:00 [ OFF ] 21:00 [ OFF ] 22:00 [ OFF ] 23:00 [ OFF ]

----- check system -----
MAIN CPU BUS           [ OK ]
FAN                    [ OK ]
INTAKE AIR TEMPERATURE [ OK ]
OPTICS MODULE TEMPERATURE [ OK ]
AROUND LAMP TEMPERATURE [ OK ]
LAMP1 REMAIN TIME      [ OK ]
LAMP2 REMAIN TIME      [ OK ]
LAMP1 STATUS           [ OK ]
LAMP2 STATUS           [ OK ]
APERTURE(CONTRAST-SHUTTER) [ OK ]
SHUTTER(MUTE-SHUTTER) [ OK ]
INTAKE AIR TEMP.SENSOR [ OK ]
OPTICS MODULE TEMP.SENSOR [ OK ]
AROUND LAMP TEMP.SENSOR [ OK ]
BATTERY                [ OK ]
COLOR WHEEL            [ OK ]
LENS MOUNTER           [ OK ]
COVER OPEN             [ OK ]
BRIGHTNESS SENSOR     [ OK ]
ANGLE SENSOR           [ OK ]
AIR FILTER CASE        [ OK ]
AIR FILTER              [ OK ]
AC POWER               [ OK ]
(Error code 00 00 00 00 00 00 00 00 00 00 00 00 00 00 00 00)

Intake air temperature : 27 degC / 80 degF
Optics module temperature : 33 degC / 91 degF
Around lamp temperature : 30 degC / 86 degF
PROJECTOR RUNTIME      1 H
POWER ON                1 times
LAMP1 ON                0 times
LAMP1 ECO               0 H
LAMP1 NORMAL            1 H
LAMP1 REMAIN            2999 H
LAMP2 ON                1 times
LAMP2 ECO               0 H
LAMP2 NORMAL            1 H
LAMP2 REMAIN            2999 H

----- Current status -----
MAIN VERSION           1.00
SUB VERSION            1.00
LAMP STATUS            LAMP1=ON LAMP2=ON
INPUT                  RGB1      ---
                                0.00kHz / 0.00Hz

REMOTE2 STATUS         DISABLE

----- Wired Network configuration -----
DHCP Client            OFF
IP address              192.168.0.8
MAC address             70:58:12:00:00

Mon Dec 03 15:39:36 2012

----- Memo -----

```

Example of the E-mail sent for an error

The following E-mail is sent when an error has occurred.

```

=== Panasonic projector report(ERROR) ===
Projector Type   : DZ870
Serial No       : SH1234567

---- check system ----
MAIN CPU BUS    [ OK ]
FAN             [ OK ]
INTAKE AIR TEMPERATURE [ OK ]
OPTICS MODULE TEMPERATURE [ OK ]
AROUND LAMP TEMPERATURE [ OK ]
LAMP1 REMAIN TIME [ OK ]
LAMP2 REMAIN TIME [ OK ]
LAMP1 STATUS    [ OK ]
LAMP2 STATUS    [ OK ]
APERTURE(CONTRAST-SHUTTER) [ OK ]
SHUTTER(MUTE-SHUTTER) [ OK ]
INTAKE AIR TEMP.SENSOR [ OK ]
OPTICS MODULE TEMP.SENSOR [ OK ]
AROUND LAMP TEMP.SENSOR [ OK ]
BATTERY        [ OK ]
COLOR WHEEL    [ OK ]
LENS MOUNTER   [ OK ]
COVER OPEN     [ OK ]
BRIGHTNESS SENSOR [ OK ]
ANGLE SENSOR   [ OK ]
AIR FILTER CASE [ FAILED]
AIR FILTER     [ OK ]
AC POWER       [ OK ]
(Error code 00 00 00 00 00 00 00 00 00 01 00 00 00 00 00)

Intake air temperature : 27 degC / 80 degF
Optics module temperature : 33 degC / 91 degF
Around lamp temperature : 30 degC / 86 degF
PROJECTOR RUNTIME      1 H
POWER ON               1 times
LAMP1 ON               0 times
LAMP1 ECO              0 H
LAMP1 NORMAL          1 H
LAMP1 REMAIN          2999 H
LAMP2 ON               1 times
LAMP2 ECO              0 H
LAMP2 NORMAL          1 H
LAMP2 REMAIN          2999 H

----- Current status -----
MAIN VERSION          1.00
SUB VERSION           1.00
LAMP STATUS           LAMP1=ON LAMP2=ON
INPUT                 RGB1    ---
                                0.00kHz / 0.00Hz

REMOTE2 STATUS        DISABLE

---- Wired Network configuration ----
DHCP Client           OFF
IP address             192.168.0.8
MAC address            70:58:12:00:00:0

Mon Dec 03 15:39:36 2012

----- Memo -----

```

**[Change password] page**

Click [Change password].

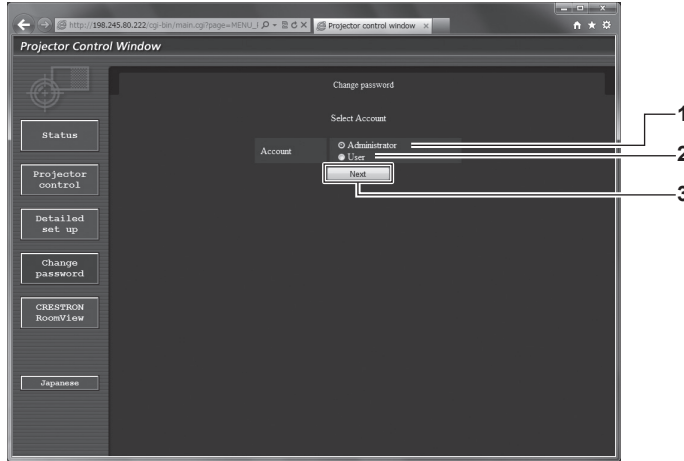

- 1 **[Administrator]**  
Used to change the setting of the [Administrator].
- 2 **[User]**  
Used to change the setting of the [User].
- 3 **[Next]**  
Used to change the setting of the password.

**[Administrator] account**

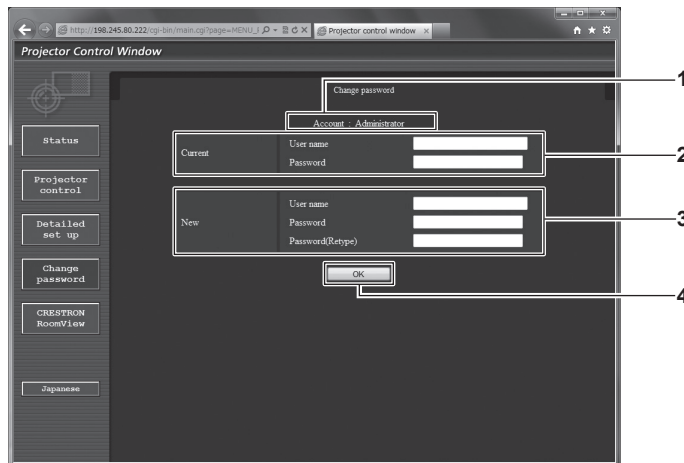

- 1 **[Account]**  
Displays the account to change.
- 2 **[Current]**  
**[User name]:**  
Enter the user name before the change.  
**[Password]:**  
Enter the current password.
- 3 **[New]**  
**[User name]:**  
Enter the desired new user name. (Up to 16 characters in single byte)  
**[Password]:**  
Enter the desired new password. (Up to 16 characters in single byte)  
**[Password(Retyp)]:**  
Enter the desired new password again.
- 4 **[OK]**  
Determines the change of password.

[User] account

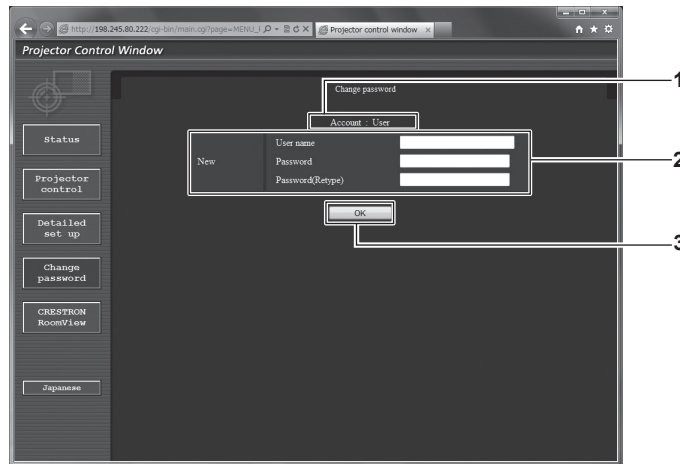

- |  |   |
|--|---|
| <p>1 <b>[Account]</b><br/>Displays the account to change.</p> <p>2 <b>[New]</b><br/><b>[User name]:</b><br/>Enter the desired new user name. (Up to 16 characters in single byte)<br/><b>[Password]:</b><br/>Enter the desired new password. (Up to 16 characters in single byte)<br/><b>[Password(Retype)]:</b><br/>Enter the desired new password again.</p> | <p>3 <b>[OK]</b><br/>Determines the change of password.</p> |
|--|---|

[Change password] (For user rights)

Only the change of password is enabled under the user rights.

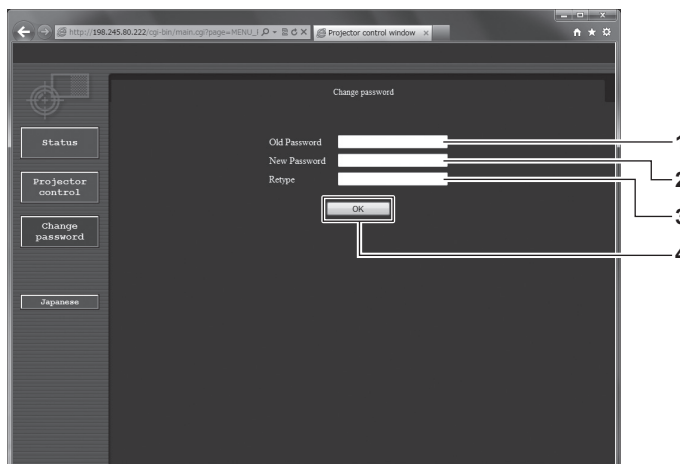

- |  |  |
|--|--|
| <p>1 <b>[Old Password]</b><br/>Enter the current password.</p> <p>2 <b>[New Password]</b><br/>Enter the desired new password. (Up to 16 characters in single byte)</p> | <p>3 <b>[Retype]</b><br/>Enter the desired new password again.</p> <p>4 <b>[OK]</b><br/>Determines the change of password.</p> |
|--|--|

**Note**

- To change the account of the administrator, you must enter the [User name] and [Password] in [Current].

**[CRESTRON RoomView] page**

The projector can be monitored/controlled with RoomView.

To start the RoomView control page from the web control screen, you need to access with the administrator rights. (For user rights, the [CRESTRON RoomView] button is not displayed on the web control screen.)

The control page of RoomView is displayed by clicking [CRESTRON RoomView].

It is not displayed if Adobe Flash Player is not installed on the computer used, or the browser used does not support Flash. In that case, click [Back] on the control page to go back to the previous page.

Control page

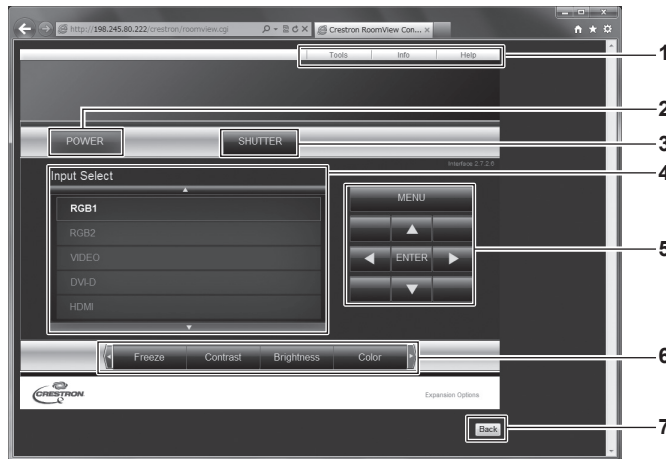

- |  |   |
|--|---|
| <p><b>1 [Tools], [Info], [Help]</b><br/>Tabs for selecting the setting, information, or help page of the projector.</p> <p><b>2 [POWER]</b><br/>Turns on/off the power.</p> <p><b>3 [SHUTTER]</b><br/>Switches the setting whether to use the shutter function (closing/opening of the shutter).</p> | <p><b>4 [Input Select]</b><br/>Controls input selection.<br/>Not available when the power of the projector is turned off.</p> <p><b>5 Menu screen control buttons</b><br/>Navigates the menu screen.</p> <p><b>6 Freeze/image quality adjustment</b><br/>Controls items related to freeze/image quality.</p> <p><b>7 [Back]</b><br/>Performs return to the previous page.</p> |
|--|---|

[Tools] page

Click [Tools] on the control page.

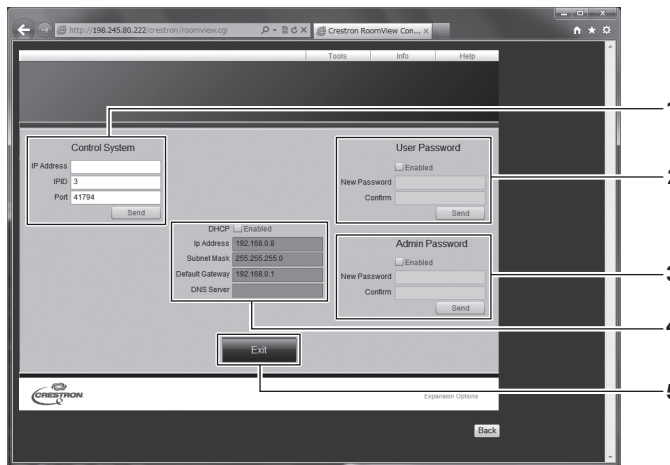

- |   |  |
|---|--|
| <p><b>1 [Control System]</b><br/>Set the information required for communicating with the controller to be connected with the projector.</p> <p><b>2 [User Password]</b><br/>Set the user rights password for the RoomView control page.</p> <p><b>3 [Admin Password]</b><br/>Set the administrator rights password for the RoomView control page.</p> | <p><b>4 Network status</b><br/>Displays the settings of wired LAN.<br/><b>[DHCP]</b><br/>Displays the current setting.<br/><b>[Ip Address]</b><br/>Displays the current setting.<br/><b>[Subnet Mask]</b><br/>Displays the current setting.<br/><b>[Default Gateway]</b><br/>Displays the current setting.<br/><b>[DNS Server]</b><br/>Displays the current setting.</p> <p><b>5 [Exit]</b><br/>Returns to the control page.</p> |
|---|--|

**[Info] page**

Click [Info] on the control page.

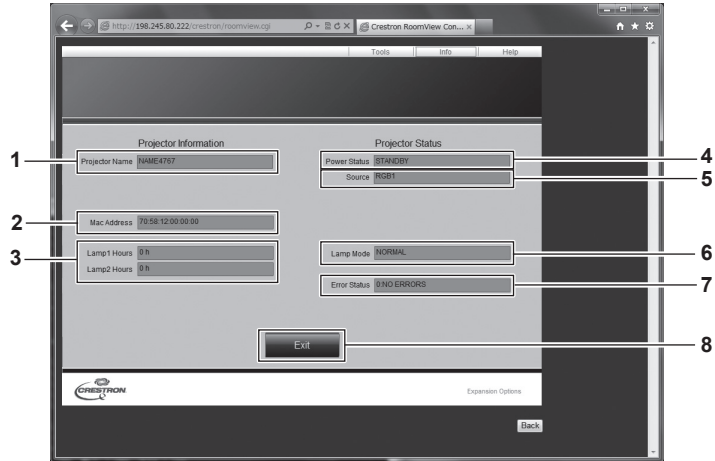

- |  |   |
|--|---|
| <p><b>1 [Projector Name]</b><br/>Displays the projector name.</p> <p><b>2 [Mac Address]</b><br/>Displays the MAC address.</p> <p><b>3 [Lamp Hours]</b><br/>Displays the runtime of the lamps (converted value).</p> <p><b>4 [Power Status]</b><br/>Displays the status of the power.</p> | <p><b>5 [Source]</b><br/>Displays the selected input.</p> <p><b>6 [Lamp Mode]</b><br/>Displays the setting status of [LAMP POWER] (► page 111).</p> <p><b>7 [Error Status]</b><br/>Displays the error status.</p> <p><b>8 [Exit]</b><br/>Returns to the control page.</p> |
|--|---|

**[Help] page**

Click [Help] on the control page.

The [Help Desk] window is displayed.



- 1 [Help Desk]**  
Send/receive messages to/from an administrator who uses Crestron RoomView.

# Chapter 5 Maintenance

---

This chapter describes methods of inspection when there are problems, maintenance, and replacement of the units.



# Lamp/temperature/filter indicators

## When an indicator lights up

If a problem should occur inside the projector, the lamp indicators <LAMP1>/<LAMP2>, the temperature indicator <TEMP>, and the filter indicator <FILTER> will inform you by lighting or flashing. Check the status of the indicators and manage the indicated problems as follows.

### Attention

- When switching off the projector to deal with problems, make sure to follow the procedure in "Switching off the projector" (➔ page 57).

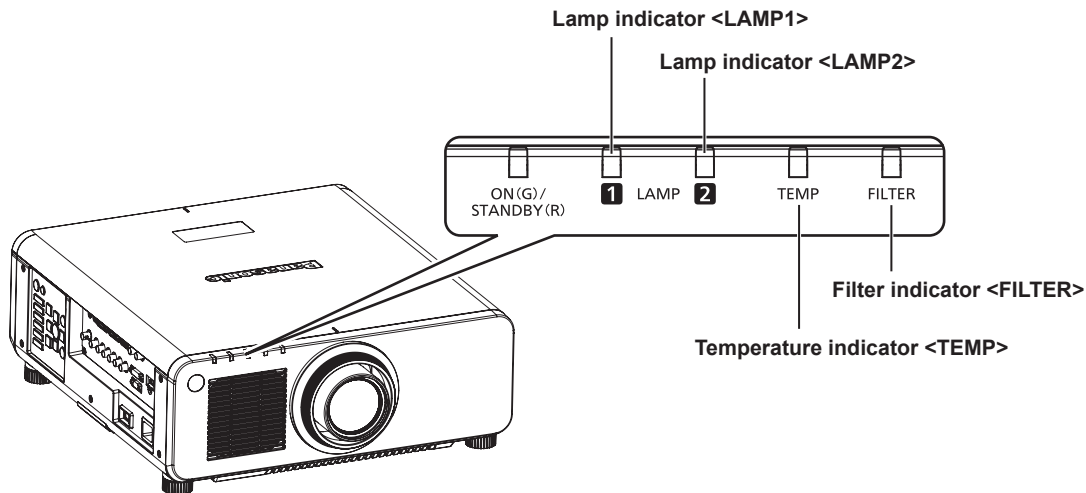

## Lamp indicators <LAMP1>/<LAMP2>

Indicator status	Lighting in red/lighting in orange <sup>*1</sup>	Flashing in red (1 time)	Flashing in red (3 times)	
<b>Status</b>	Time to replace the lamp unit. (➔ page 161)	The lamp unit is not installed.	A problem is detected in the lamp or the power supply for the lamp.	
<b>Cause</b>	<ul style="list-style-type: none"> <li>Was [REPLACE LAMP] displayed when you turned on the power?</li> <li>The indicator lights up when the runtime of the lamp unit reaches 2 800 hours (when [LAMP POWER] is set to [NORMAL]).</li> </ul>	<ul style="list-style-type: none"> <li>Is the lamp unit attached?</li> </ul>	<ul style="list-style-type: none"> <li>Have you turned on the power again immediately after turning it off?</li> </ul>	<ul style="list-style-type: none"> <li>Some error has occurred in the lamp circuit. Check for fluctuation (or drop) in the source voltage.</li> </ul>
<b>Solution</b>	<ul style="list-style-type: none"> <li>Replace the lamp unit.</li> </ul>	<ul style="list-style-type: none"> <li>Install the lamp unit if it is not installed.</li> <li>If the indicator is still flashing in red even when having installed the lamp unit, consult your dealer.</li> </ul>	<ul style="list-style-type: none"> <li>Wait a while until the luminous lamp cools off, and then turn on the power.</li> </ul>	<ul style="list-style-type: none"> <li>Turn the &lt;MAIN POWER&gt; switch to &lt;OFF&gt; (➔ page 57), and consult your dealer.</li> </ul>

\*1 The indicator lights up in red while the lamp is turned off, and lights up in orange while the lamp is turned on.

### Note

- If the lamp indicators <LAMP1>/<LAMP2> are still lit or flashing after taking the preceding measures, ask your dealer for repair.

Temperature indicator <TEMP>

Indicator status	Lighting in red		Flashing in red (2 times)	Flashing in red (3 times)
Status	Warm-up status	Internal temperature is high (warning).	Internal temperature is high (standby status).	The cooling fan has stopped.
Cause	<ul style="list-style-type: none"> <li>Did you turn on the power when the temperature was low (around 0 °C (32 °F))?</li> </ul>	<ul style="list-style-type: none"> <li>Is the air intake/exhaust port blocked?</li> <li>Is the room temperature high?</li> <li>Is the filter indicator &lt;FILTER&gt; lit?</li> </ul>		—
Solution	<ul style="list-style-type: none"> <li>Wait at least five minutes in the current status.</li> <li>Install the projector in a location with the operating environment temperature between 0 °C (32 °F) and 45 °C (113 °F)*1.</li> </ul>	<ul style="list-style-type: none"> <li>Remove any objects that are blocking the air intake/exhaust port.</li> <li>Install the projector in a location with the operating environment temperature between 0 °C (32 °F) and 45 °C (113 °F)*1.</li> <li>Do not use the projector at high altitudes of 2 700 m (8 858') or higher above sea level.</li> <li>Clean or replace the air filter. (➔ page 159)</li> </ul>		<ul style="list-style-type: none"> <li>Turn the &lt;MAIN POWER&gt; switch to &lt;OFF&gt; (➔ page 57), and consult your dealer.</li> </ul>

\*1 When using the projector at high altitudes (1 400 m (4 593') or higher – lower than 2 700 m (8 858') above sea level), the operating environment temperature should be between 0 °C (32 °F) and 40 °C (104 °F).

Note

- If the temperature indicator <TEMP> is still lit or flashing after taking the preceding measures, ask your dealer for repair.
- If you use the projector with the following two settings, the light output may drop by approx. 20 % to protect the projector when the operating environment temperature becomes 40 °C (104 °F) or higher (35 °C (95 °F) or higher when [HIGH ALTITUDE MODE] is set to [ON]).
  - When [LAMP SELECT] is set to [DUAL] from the menu
  - When [LAMP POWER] is set to [NORMAL] from the menu

Filter indicator <FILTER>

Indicator status	Lighting in red			Flashing in red
Status	The filter is clogged. The temperature inside or outside the projector is abnormally high.			The air filter case is not attached.
Cause	<ul style="list-style-type: none"> <li>Is the air filter dirty?</li> </ul>	<ul style="list-style-type: none"> <li>Is the air intake/exhaust port blocked?</li> </ul>	<ul style="list-style-type: none"> <li>Is [HIGH ALTITUDE MODE] set correctly?</li> </ul>	<ul style="list-style-type: none"> <li>Is the air filter case attached?</li> </ul>
Solution	<ul style="list-style-type: none"> <li>Clean or replace the air filter. (➔ page 159)</li> </ul>	<ul style="list-style-type: none"> <li>Remove any objects that are blocking the air intake/exhaust port.</li> </ul>	<ul style="list-style-type: none"> <li>When using the projector at high altitudes between 1 400 m (4 593') or higher and lower than 2 700 m (8 858') above sea level, set [HIGH ALTITUDE MODE] (➔ page 109) to [ON].</li> <li>Do not use the projector at high altitudes of 2 700 m (8 858') or higher above sea level.</li> </ul>	<ul style="list-style-type: none"> <li>Attach the air filter case.</li> </ul>

Note

- If the filter indicator <FILTER> is still lit or flashing after taking the preceding measures, ask your dealer for repair.
- If the air filter case is not attached when the projector is switched on, the filter indicator <FILTER> flashes in red, and then the projector is switched off after ten minutes.
- If the filter is clogged, only one lamp may light even when [LAMP SELECT] is set to [DUAL]. The status can be reset when the air filter is cleaned or replaced.

# Maintenance/replacement

## Before performing maintenance/replacement

- Make sure to turn off the power before maintaining the projector or replacing the unit. (➔ pages 54, 57)
- When switching off the projector, make sure to follow the procedures in “Switching off the projector” (➔ page 57).

## Maintenance

### Outer case

Wipe off dirt and dust with a soft, dry cloth.

- If the dirt is persistent, soak the cloth with water and wring it thoroughly before wiping. Dry off the projector with a dry cloth.
- Do not use benzene, thinner, or rubbing alcohol, other solvents, or household cleaners. Doing so may deteriorate the outer case.
- When using chemically treated dust cloths, follow the instructions written on its packaging.

### Lens front surface

Wipe off dirt and dust from the front surface of the lens with a soft clean cloth.

- Do not use a cloth that is fluffy, dusty, or soaked with oil/water.
- Since the lens is fragile, do not use excessive force when wiping the lens.

### Attention

- The lens is made of glass. Impacts or excessive force when wiping may scratch its surface. Handle with care.

### Air Filter

Perform maintenance of the air filter in the following cases.

- The air filter is clogged with dust, causing the filter replacement message to appear on the screen and the filter indicator <FILTER> to light in red.

### Removing the air filter

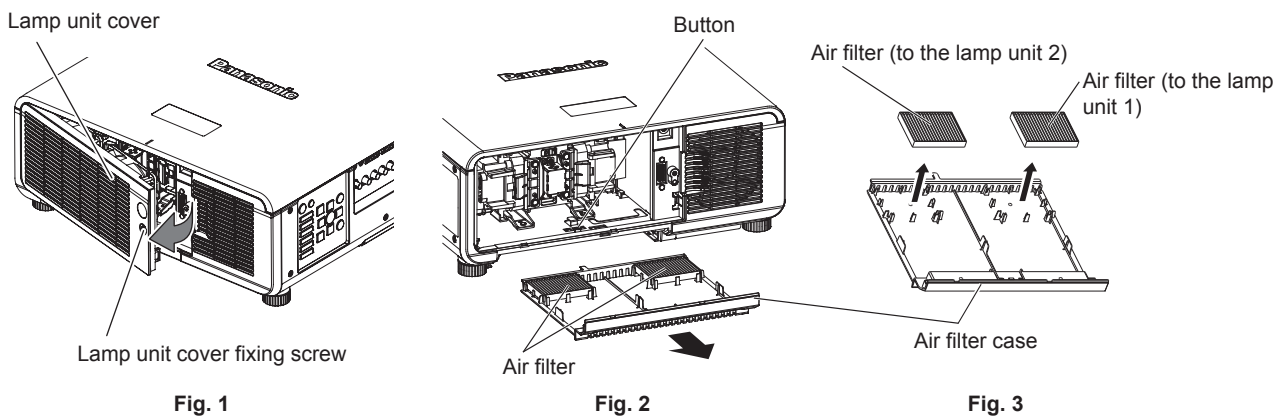

#### 1) Remove the lamp unit cover. (Fig. 1)

- Use a Phillips screwdriver to turn the lamp unit cover fixing screw (x1) counterclockwise until it turns freely, and open the lamp unit cover slowly in the direction of the arrow.
- Opening the lamp unit cover quickly may result in damage to the cover.
- If you loosen the lamp unit cover fixing screw with the projector installed upward in the vertical direction, the lamp unit cover may open on its weight and the lamp unit may be dropped off.

#### 2) Pull out the air filter case. (Fig. 2)

- Pull out the air filter case from the projector while pressing the button on the projector.

#### 3) Remove the air filter from the air filter case. (Fig. 3)

### Cleaning the air filter

Remove the air filter beforehand with the previously described procedure of "Removing the air filter".

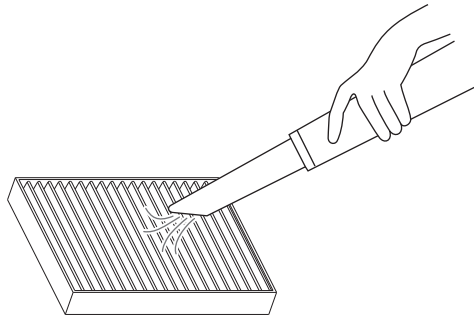

#### 1) Clean the air filter.

- Vacuum dust from the air filter with a vacuum cleaner.

### Attaching the air filter

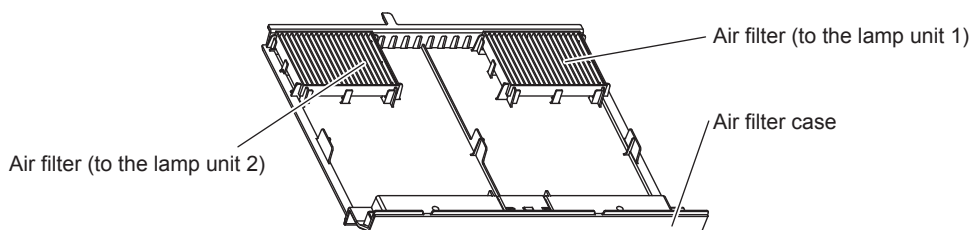

Fig. 1

#### 1) Attach the air filter. (Fig. 1)

- Insert the air filter to the filter case rib securely.

#### 2) Attach the air filter case to the projector.

- Push in the air filter case securely until the clicking sound is made.

#### 3) Attach the lamp unit cover.

- Close the lamp unit cover in the reverse order of Step 1) of "Removing the air filter".
- Attach the lamp unit cover so that the connector of the lamp unit cover is inserted to the fan power connector securely.
- Use a Phillips screwdriver to firmly tighten the lamp unit fixing screw (x1).
- Make sure to attach the lamp unit cover securely.

### Note

- Make sure that the air filter case is properly attached before using the projector. If it is not properly attached, the projector will suck in dirt and dust causing a malfunction.
- If you use the projector without attaching the air filter case, the filter indicator <FILTER> flashes in red and the message appears on the projection screen for approximately 30 seconds.
- Do not use water when washing the air filter. Washing with water may decrease the dust absorption capability.
- When the dust remains after cleaning, it is time to replace the air filter.

The air filter for replacement (TMZX5209) is an optional accessory (service part). To purchase the product, consult your dealer.

One air filter is provided for the optional Replacement lamp unit (Model No.: ET-LAD120 (1 pc)), and two air filters are provided for the optional Replacement lamp unit (Model No.: ET-LAD120W (2 pcs)).

## Replacing the unit

### Lamp unit

The lamp unit is a consumable component. Refer to "When to replace the lamp unit" (➡ page 161) for details about the replacement cycle. When purchasing the optional accessory of Replacement lamp unit (Model No.: ET-LAD120 (1 pc), ET-LAD120W (2 pcs)), consult your dealer. It is recommended that you request a qualified technician to replace the lamp unit. Consult your dealer.

### Warning

**Replace the lamp unit after the lamp has cooled (after waiting at least one hour).**

The high temperature inside the cover will cause burns.

## Checking the lamp unit to be replaced

### 1) Check the status of the lamp indicators <LAMP1>/<LAMP2>.

- The lamp unit corresponding to the lamp indicator that is lit in red is required to be replaced.

### Notes on the replacement of the lamp unit

- A Phillips screwdriver is necessary when replacing the lamp unit.
- Since the luminous lamp is made of glass, it may burst if dropped or hit with a hard object. Handle with care.
- Do not disassemble or modify the lamp unit.
- When replacing the lamp unit, be sure to hold it by the handle because its surface is pointed and its shape is protruded.
- The lamp may rupture. Replace the lamp unit carefully so the glass fragments of the lamp do not scatter. While attaching the projector to the ceiling, do not work right under the lamp unit or do not conduct work while your face is near the lamp unit.
- The lamp contains mercury. When disposing of used lamp units, contact your local authorities or dealer for correct methods of disposal.

### Attention

- Panasonic takes no responsibility for any damage or malfunction of the product resulting from use of lamp units which are not manufactured by Panasonic. Use only specified lamp units.

### Note

- The model numbers of accessories and optional accessories are subject to change without prior notice.

### When to replace the lamp unit

The lamp unit is a consumable component. Since its brightness gradually decreases over time, it is necessary to replace the lamp unit regularly. The estimated duration before replacement is 3 000 hours, but the lamp may go off before reaching to 3 000 hours, depending on the characteristics of the individual lamp, usage conditions, and the installation environment. It is recommended that the Replacement lamp unit be prepared earlier.

If you continue to use the lamp unit after 3 000 hours has elapsed, the lamp turns off automatically after approximately 10 minutes, as it may cause malfunction of the projector.

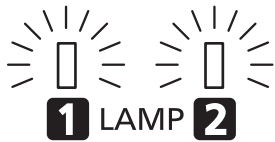
	On-screen display	Lamp indicator
		
Over 2 800 hours	The message is displayed for 30 seconds. Pressing any button on the control panel or remote control within 30 seconds will clear the message.	The indicator lights in red even during the standby mode. (Only the corresponding lamp lights on.)
Over 3 000 hours	The message remains displayed until you press any button.	

### Note

- To predict when to replace the lamp, check the lamp runtime displayed on [LAMP1] and [LAMP2] in [STATUS] (➔ page 119).
- 3 000 hours is only the target for replacement and not the warranty time.

## How to replace the lamp unit

### Attention

- When the projector is mounted on the ceiling, do not conduct work while your face is near the lamp unit.
- Make sure to attach the lamp unit and the lamp unit cover securely.
- If the lamp unit is not installed properly, remove it and then push it in slowly. Pushing it in quickly or forcibly may break the connector.

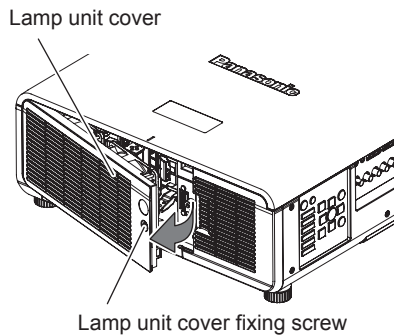

Fig. 1

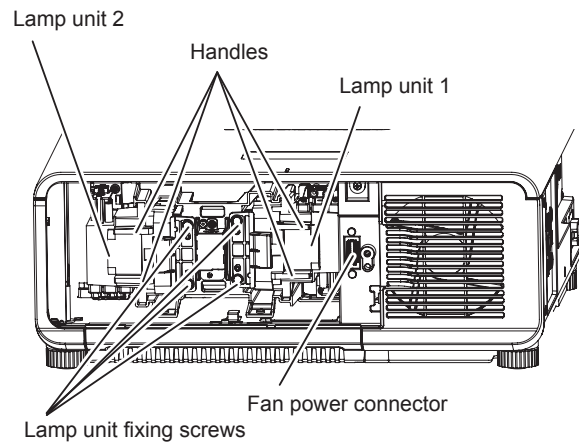

Fig. 2

- 1) **Set the <MAIN POWER> switch to <OFF> and disconnect the power plug from the power outlet.**
  - Wait at least one hour and check if the lamp unit has cooled down.
- 2) **Remove the lamp unit cover. (Fig. 1)**
  - Use a Phillips screwdriver to turn the lamp unit cover fixing screw (x1) counterclockwise until it turns freely, and open the lamp unit cover slowly in the direction of the arrow.
  - Opening the lamp unit cover quickly may result in damage to the cover.
  - If you loosen the lamp unit cover fixing screw with the projector installed upward in the vertical direction, the lamp unit cover may open on its weight and the lamp unit may be dropped off.
- 3) **Remove the lamp unit. (Fig. 2)**
  - Use a Phillips screwdriver to turn the lamp unit fixing screws (x2) counterclockwise until they turn freely, and then remove the lamp unit.
  - Hold the handles of the lamp unit and remove it straight.
- 4) **Push in the new lamp unit while paying attention to the insertion position.**
  - If the lamp unit is not installed properly, remove it and then push it in slowly. Pushing it in quickly or forcibly may break the connector.
- 5) **Use a Phillips screwdriver to firmly tighten the lamp unit fixing screws (x2 each).**
  - Make sure to attach the lamp unit securely.
- 6) **Attach the lamp unit cover.**
  - i) Close the lamp unit cover in Step 2) in the reverse order.
    - Attach the lamp unit cover so that the connector of the lamp unit cover is inserted to the fan power connector securely.
  - ii) Use a Phillips screwdriver to firmly tighten the lamp unit fixing screw (x1).
    - Make sure to attach the lamp unit cover securely.

### Note

- When you replace the lamp unit with new one, the projector resets the runtime of the lamp unit automatically.

### Air filter

When the dust remains after cleaning, the filter replacement timing has come.

The air filter for the replacement (TMZX5209) is the optional accessories (service part). To purchase the product, consult your dealer.

When replacing the lamp unit, replace the corresponding air filter.

One air filter is provided for the optional accessory of Replacement lamp unit (Model No.: ET-LAD120 (1 pc)) and two air filters are attached to Replacement lamp unit (Model No.: ET-LAD120W (2 pcs)).

### Replacing the air filter

---

#### Attention

---

- Make sure to turn off the power before replacing the air filter.
- When attaching the air filter, make sure that the projector is stable, and perform the replacement in a safe place where the unit will not be damaged even if you drop the air filter.

#### 1) Remove the air filter.

- Refer to “Removing the air filter” (➔ page 159).

#### 2) Replace the air filter to the new one and attach the air filter case to the projector.

- Refer to “Attaching the air filter” (➔ page 160).

#### Attention

---

- When switching on the projector, make sure that the air filter is attached. If it is not properly attached, the projector will suck in dirt and dust causing a malfunction.
- If you use the projector without attaching the air filter case, the filter indicator <FILTER> flashes in red and the message appears on the projection screen for approximately 30 seconds.

# Troubleshooting

Review the following points. For details, see the corresponding pages.

Problems	Points to be checked	Page
<b>Power does not turn on.</b>	• Is the power plug firmly inserted into the outlet?	—
	• Is the <MAIN POWER> switch set to <OFF>?	57
	• Is the wall outlet supplying electricity?	—
	• Have the circuit breakers tripped?	—
	• Are the lamp indicator <LAMP1>/<LAMP2> or the temperature indicator <TEMP> lit or flashing?	157
	• Is the lamp unit cover attached?	162
<b>No image appears.</b>	• Are connections to external devices correctly performed?	49
	• Is the input selection setting correct?	62
	• Is the [BRIGHTNESS] adjustment setting at a minimum?	71
	• Is the external device that is connected to the projector working properly?	—
	• Is the shutter function in use?	61
	• If the power indicator <ON (G)/STANDBY (R)> is flashing in red, consult your dealer.	—
	• Is the lens cover still attached to the lens?	55
<b>Image is fuzzy.</b>	• Is the lens focus set correctly?	58
	• Is the projection distance appropriate?	33
	• Is the lens dirty?	19
	• Is the projector installed perpendicular to the screen?	—
<b>Color is pale or grayish.</b>	• Is [COLOR] or [TINT] adjusted correctly?	72
	• Is the external device connected to the projector adjusted correctly?	49
	• Is the RGB cable damaged?	—
<b>Remote control does not respond.</b>	• Are the batteries depleted?	—
	• Is the polarity of the batteries set correctly?	29
	• Are there any obstructions between the remote control and the remote control signal receiver of the projector?	25
	• Is the remote control being used beyond its effective operation range?	25
	• Are other forms of light, such as fluorescent light, affecting the projection?	25
	• Is the [REMOTE CONTROL] setting in [CONTROL DEVICE SETUP] set to [DISABLE]?	131
	• Is the <REMOTE 2 IN> terminal used for contact control?	176
	• Is the ID number setting operation correct?	29
<b>Menu screen does not appear.</b>	• Is the on-screen display function turned off (hidden)?	101
<b>Buttons on the control panel do not operate.</b>	• Is the [CONTROL PANEL] setting in [CONTROL DEVICE SETUP] set to [DISABLE]?	131
	• Is the <REMOTE 2 IN> terminal used for contact control?	176
<b>Image does not display correctly.</b>	• Is the [SYSTEM SELECTOR] selection set correctly?	76
	• Is there a problem with the video tape or other image sources?	—
	• Is a signal which is not compatible with the projector being input?	178
<b>Image from a computer does not appear.</b>	• Is the cable too long? (Use D-Sub cables that are 10 m (32'10") or shorter.)	—
	• Is the external video output on the laptop computer set correctly? (Ex.: The external output settings may be switched by pressing "Fn" + "F3" or "Fn" + "F10" simultaneously. Since the method varies depending on the computer type, refer to the user manual provided with your computer.)	—
<b>Image output from DVI-D of the computer does not appear.</b>	• Is the [DVI-D IN] setting [EDID3] or [EDID2:PC]?	98
	• The graphics accelerator driver of the computer may need to be updated to the latest version.	—
	• The computer may need to be restarted after performing the [DVI-D IN] setting.	98
<b>Video from HDMI compatible device does not appear or it appears jumbled.</b>	• Is the HDMI cable connected securely?	49
	• Turn the power of the projector and the external device on and off.	—
	• Is a signal which is not compatible with the projector being input?	178
<b>Cannot control the projector with Art-Net.</b>	• Are the connections between the twisted-pair-cable transmitter and the projector or an external device correctly done?	—
	• Is the [Art-Net] setting [ON]?	—
	• Are the [PORT ADDRESS] and [START ADDRESS] settings correct?	—



## Chapter 5 Maintenance — Troubleshooting

Problems	Points to be checked	Page
<b>The DIGITAL LINK input image is not displayed.</b>	• Are the connections between the twisted-pair-cable transmitter and the projector or an external device correctly done?	—
	• Is [DIGITAL LINK MODE] set to [AUTO] or [DIGITAL LINK]? Is it set to [ETHERNET]?	134
	• Is a signal which is not compatible with a twisted-pair-cable transmitter being input?	—
<b>3D function is not working.</b>	• Is the [3D INPUT FORMAT] setting of [3D SETTINGS] correct?	91
	• Check the 3D eyewear settings.	—
	• Is a signal which is supported by the projector being input?	180
<b>Left and right images are reversed (not showing properly).</b>	• Are the devices synchronized? Check the 3D eyewear settings.	—
	• Change the [LEFT/RIGHT SWAP] setting of [3D SETTINGS].	92
<b>Image in the 3D eyewear flickers.</b>	• Are you within the reception range?	—
<b>3D eyewear is not functioning.</b>	• Are batteries of the 3D eyewear drained? If you use the rechargeable 3D eyewear, charge it. If you use the battery-powered 3D eyewear, replace the battery.	—
	• Is the [3D SETTINGS] setting correct?	90

### **Attention**

- If problems persist even after checking the preceding points, consult your dealer.

# Chapter 6 Appendix

---

This chapter describes specifications and after-sales service for the projector.

# Technical information

## PJLink protocol

The network function of this projector supports the PJLink class 1, and the PJLink protocol can be used to perform projector setting and projector status query operations from a computer.

### Control commands

The following table lists the PJLink protocol commands that can be used to control the projector.

- x characters in tables are non-specific characters.

Command	Control details	Parameter / return string	Remark		
POWR	Power supply control	0 1	Standby Power on		
POWR?	Power supply status query	0 1 2 3	Standby Power on Preparing for switching off the projector Warm-up		
INPT	Input selection	11 12 21	RGB1 RGB2 VIDEO		
INPT?	Input selection query	31 32 33 34	DVI-D HDMI DIGITAL LINK SDI (only for PT-DZ870E)		
AVMT	Shutter control	30	Shutter function off (shutter open)		
AVMT?	Shutter status query	31	Shutter function on (shutter closed)		
ERST?	Error status query	xxxxxx	1st byte	Indicates fan errors, and returns 0 - 2.	<ul style="list-style-type: none"> <li>• 0 = No error is detected</li> <li>• 1 = Warning</li> <li>• 2 = Error</li> </ul>
			2nd byte	Indicates lamp errors, and returns 0 - 2.	
			3rd byte	Indicates temperature errors, and returns 0 - 2.	
			4th byte	Indicates cover open errors, and returns 0 or 2.	
			5th byte	Indicates filter errors, and returns 0 - 2.	
			6th byte	Indicates other errors, and returns 0 - 2.	
LAMP?	Lamp status query	xxxxxxxxxxx	1st digits (1 - 5 digits): Lamp 1 runtime 2nd digit: 0 = Lamp 1 off, 1 = Lamp 1 on 3rd digits (1 - 5 digits): Lamp 2 runtime 4th digit: 0 = Lamp 2 off, 1 = Lamp 2 on		
INST?	Input selection list query	11 12 21 31 32 33 34	Only for PT-DZ870E		
		11 12 21 31 32 33	Only for PT-DW830E, PT-DX100E		
NAME?	Projector name query	xxxxx	Returns the name set in [PROJECTOR NAME] of [NETWORK SETUP].		
INF1?	Manufacturer name query	Panasonic	Returns manufacturer name.		
INF2?	Model name query	DZ870 DW830 DX100	Returns model name.		
INF0?	Other information queries	xxxxx	Returns information such as version number.		
CLSS?	Class information query	1	Returns class for PJLink.		

## PJLink security authentication

The password used for PJLink is the same as that of the password set for web control.

When using the projector without security authentication, do not set a password for web control.

- For specifications related to PJLink, refer to the website of Japan Business Machine and Information System Industries Association.  
URL <http://pjlink.jbmia.or.jp/english/>

## Using Art-Net function

The network function of the projector supports the Art-Net function, and the Art-Net protocol can operate the DMX controller setting, and the application software can control the projector setting.

### CHANNEL DEFINITION

The following table lists the channel definitions used for controlling the projector with the Art-Net function.

Channel	Control details	Performance	Parameter	Remark	
1	Shutter control	SHUTTER:OPEN	0-63		
		No operation	64-191		
		SHUTTER:CLOSE	192-255		
2	Input selection	No operation	0-7		
		RGB1	8-15		
		RGB2	16-23		
		VIDEO	24-31		
		DVI-D	32-39		
		HDMI	40-47		
		DIGITAL LINK	48-55		
		SDI (only for PT-DZ870E)	56-63		
		No operation	64-127		
		Execute P IN P, USER1	128-135		
		Execute P IN P, USER2	136-143		
		Execute P IN P, USER3	144-151		
		No operation	152-255		
3	Lens function select	No operation	0-15	Operate together with "Lens adjustment" of the channel 4.	
		Lens H shift	16-31		
		Lens V shift	32-47		
		Lens focus	48-63		
		Lens zoom	64-79		
		Move to the home position	80-95		Operate together with "Command performance execute" of the channel 4.
		No operation	96-255		
4	Lens control	Lens adjustment	(-) High speed	0-31	
			(-) Low speed	32-63	
			(-) Fine adjustment	64-95	
		Adjustment stop	96-127		
		Lens adjustment	(+) Fine adjustment	128-159	
			(+) Low speed	160-191	
			(+) High speed	192-223	
		Command performance execute	224-255		
5	Power supply control	Standby	0-63		
		No operation	64-191		
		Power on	192-255		
6	Light volume adjustment	100 %	0	Can be set in 256 steps between 100 % and 0 %.	
		...	...		
		0 %	255		
7	Lock	Operation not available	0-127	When "Operation not available" is set, operation of all channels become unacceptable.	
		Operation available	128-255		

Chapter 6 Appendix — Technical information

Channel	Control details	Performance	Parameter	Remark
8	Fade-in time setting	0.0s	0-15	Operate together with channel 1.
		0.5s	16-31	
		1.0s	32-47	
		1.5s	48-63	
		2.0s	64-79	
		2.5s	80-95	
		3.0s	96-111	
		3.5s	112-127	
		4.0s	128-143	
		5.0s	144-159	
		7.0s	160-175	
		10.0s	176-191	
		No operation	192-255	
9	Fade-out time setting	0.0s	0-15	Operate together with channel 1.
		0.5s	16-31	
		1.0s	32-47	
		1.5s	48-63	
		2.0s	64-79	
		2.5s	80-95	
		3.0s	96-111	
		3.5s	112-127	
		4.0s	128-143	
		5.0s	144-159	
		7.0s	160-175	
		10.0s	176-191	
		No operation	192-255	
10	Custom masking	OFF	0-31	To use this function, the optional Upgrade Kit (Model No.: ET-UK20) is required.
		PC-1	32-63	
		PC-2	64-95	
		PC-3	96-127	
		No operation	128-255	
11	Geometry	OFF	0-15	(Only for PT-DZ870E) To use PC-1, PC-2, or PC-3, the optional Upgrade Kit (Model No.: ET-UK20) is required.
		KEystone	16-31	
		CURVED	32-47	
		PC-1	48-63	
		PC-2	64-79	
		PC-3	80-95	
		CORNER CORRECTION	96-111	
		No operation	112-255	

**Note**

- If the projector is operated with the remote control or on the control panel, or by the control command while controlling the projector by using the Art-Net function, the setting of the DMX controller and the computer application may be different from the projector status. In that case, set the "Lock" setting of the channel 7 to "Operation not available" and then reset to "Operation available". The controls of all channels become reflected to the projector.

## Control commands via LAN

### When web control administrator rights password is set (Protect mode)

#### Connecting

1) Obtain the IP address and port number (Initial set value = 1024) of the projector and request for a connection to the projector.

- You can obtain both the IP address and the port number from the menu screen of the projector.

<b>IP address</b>	Obtain from the main menu → [NETWORK] → [NETWORK STATUS]
<b>Port number</b>	Obtain from the main menu → [NETWORK] → [NETWORK CONTROL] → [COMMAND PORT]

2) Check the response from the projector.

	Data section	Blank	Mode	Blank	Random number section	Termination symbol
<b>Command example</b>	"NTCONTROL" (ASCII string)	' '	'1'	' '	"zzzzzzzz" (ASCII code hex number)	(CR) 0x0d
<b>Data length</b>	9 bytes	1 byte	1 byte	1 byte	8 bytes	1 byte

- Mode: 1 = Protect mode

3) Generate a 32-byte hash value from the following data using MD5 algorithm.

- "xxxxxx:yyyy:zzzzzzzz"

<b>xxxxxx</b>	Administrator rights user name for the web control (default user name is "admin1")
<b>yyyyy</b>	Password of above administrator rights user (default password is "panasonic")
<b>zzzzzzzz</b>	8-byte random number obtained in Step 2)

#### Command transmission method

Transmit using the following command formats.

##### ■ Transmitted data

	Header			Data section	Termination symbol
<b>Command example</b>	Hash value (Refer to "Connecting" above)	'0' 0x30	'0' 0x30	Control command (ASCII string)	(CR) 0x0d
<b>Data length</b>	32 bytes	1 byte	1 byte	Undefined length	1 byte

##### ■ Received data

	Header		Data section	Termination symbol
<b>Command example</b>	'0' 0x30	'0' 0x30	Control command (ASCII string)	(CR) 0x0d
<b>Data length</b>	1 byte	1 byte	Undefined length	1 byte

##### ■ Error response

	String	Details	Termination symbol
<b>Message</b>	"ERR1"	Undefined control command	(CR) 0x0d
	"ERR2"	Out of parameter range	
	"ERR3"	Busy state or no-acceptable period	
	"ERR4"	Timeout or no-acceptable period	
	"ERR5"	Wrong data length	
	"ERRA"	Password mismatch	
<b>Data length</b>	4 bytes	—	1 byte

**When web control administrator rights password is not set (Non-protect mode)**

**Connecting**

**1) Obtain the IP address and port number (Initial set value = 1024) of the projector and request for a connection to the projector.**

- You can obtain both the IP address and the port number from the menu screen of the projector.

<b>IP address</b>	Obtain from the main menu → [NETWORK] → [NETWORK STATUS]
<b>Port number</b>	Obtain from the main menu → [NETWORK] → [NETWORK CONTROL] → [COMMAND PORT]

**2) Check the response from the projector.**

	Data section	Blank	Mode	Termination symbol
<b>Command example</b>	“NTCONTROL” (ASCII string)	‘ ’ 0x20	‘0’ 0x30	(CR) 0x0d
<b>Data length</b>	9 bytes	1 byte	1 byte	1 byte

- Mode: 0 = Non-protect mode

**Command transmission method**

Transmit using the following command formats.

**■ Transmitted data**

	Header		Data section	Termination symbol
<b>Command example</b>	‘0’ 0x30	‘0’ 0x30	Control command (ASCII string)	(CR) 0x0d
<b>Data length</b>	1 byte	1 byte	Undefined length	1 byte

**■ Received data**

	Header		Data section	Termination symbol
<b>Command example</b>	‘0’ 0x30	‘0’ 0x30	Control command (ASCII string)	(CR) 0x0d
<b>Data length</b>	1 byte	1 byte	Undefined length	1 byte

**■ Error response**

	String	Details	Termination symbol
<b>Message</b>	“ERR1”	Undefined control command	(CR) 0x0d
	“ERR2”	Out of parameter range	
	“ERR3”	Busy state or no-acceptable period	
	“ERR4”	Timeout or no-acceptable period	
	“ERR5”	Wrong data length	
	“ERRA”	Password mismatch	
<b>Data length</b>	4 bytes	—	1 byte

**<SERIAL IN>/<SERIAL OUT> terminal**

The <SERIAL IN>/<SERIAL OUT> terminal of the projector conforms with RS-232C so that the projector can be connected to and controlled from a computer.

Connection

● Single projector

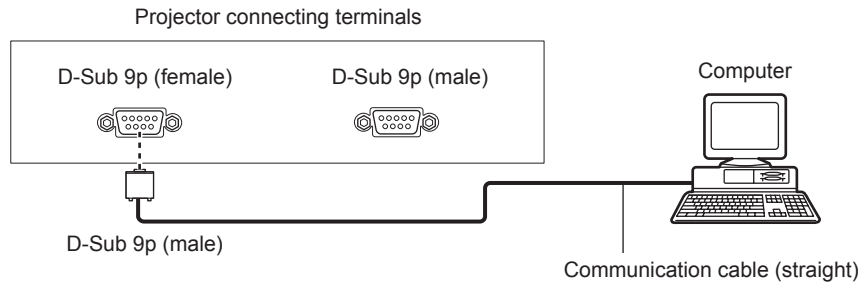

● Multiple projectors

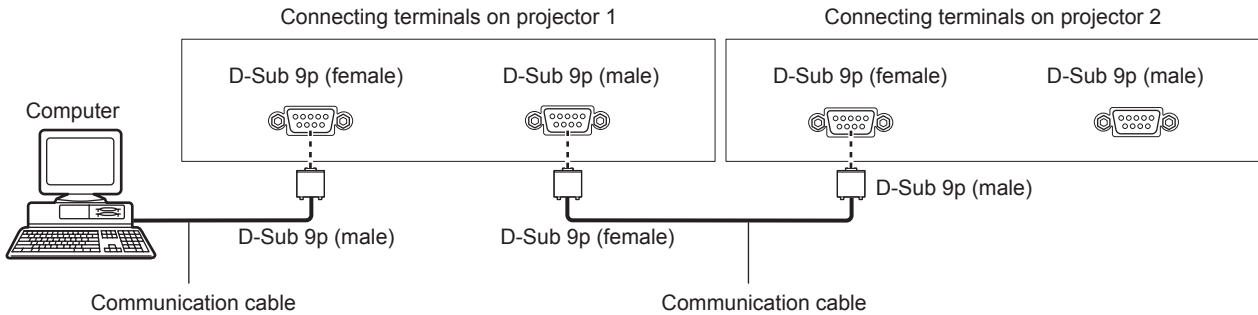

● When connecting with the DIGITAL LINK compatible devices

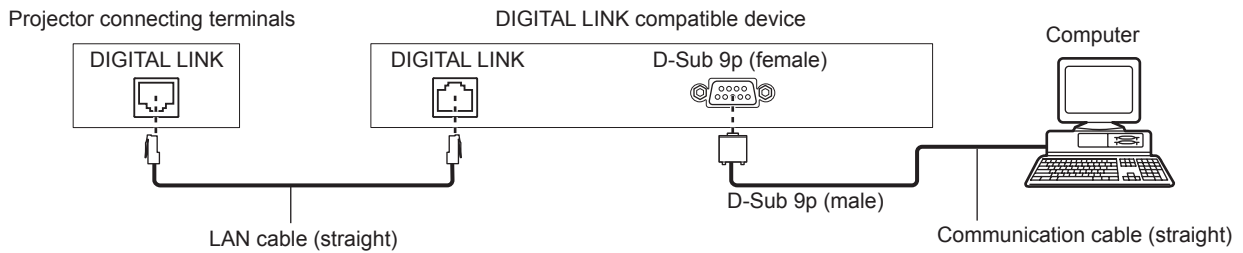

Note

- The destination of [RS-232C] (➔ page 118) must be set according to the connection method.
- When connecting by a DIGITAL LINK compatible device, set the [PROJECTOR SETUP] menu → [STANDBY MODE] (➔ page 116) setting to [NORMAL] to control the projector during standby.  
When [STANDBY MODE] is set to [ECO], the projector cannot be control during standby.

Pin assignments and signal names

D-Sub 9-pin (female) Outside view	Pin No.	Signal name	Details
	(1)	—	NC
	(2)	TXD	Transmitted data
	(3)	RXD	Received data
	(4)	—	NC
	(5)	GND	Earth
	(6)	—	NC
	(7)	CTS	Connected internally
	(8)	RTS	
	(9)	—	NC



D-Sub 9-pin (male) Outside view	Pin No.	Signal name	Details
	(1)	—	NC
	(2)	RXD	Received data
	(3)	TXD	Transmitted data
	(4)	—	NC
	(5)	GND	Earth
	(6)	—	NC
	(7)	RTS	Connected internally
	(8)	CTS	
	(9)	—	NC

### Communication conditions (Factory default)

Signal level	RS-232C-compliant
Sync. method	Asynchronous
Baud rate	9 600 bps
Parity	None
Character length	8 bits
Stop bit	1 bit
X parameter	None
S parameter	None

### Basic format

Transmission from the computer starts with STX, then the ID, command, parameter, and ETX are sent in this order. Add parameters according to the details of control.

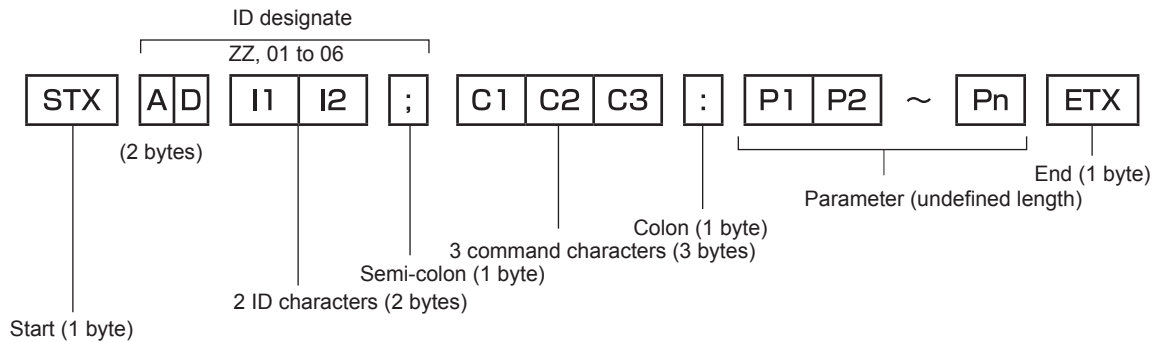

### Basic format (has subcommands)

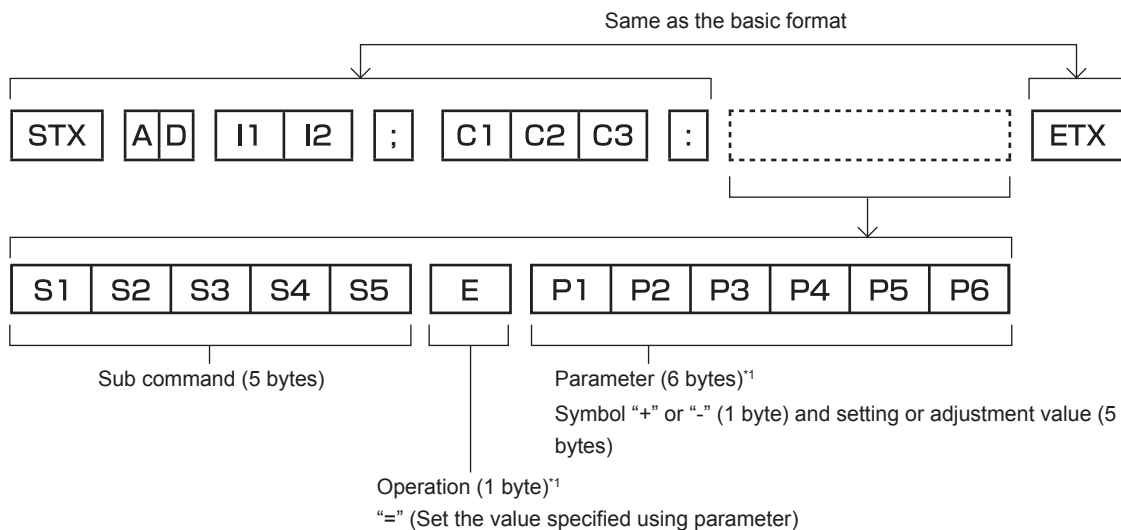

\*1 When transmitting a command which does not need a parameter, an operation (E) and parameter are not necessary.

**Attention**

- If a command is transmitted after the lamp starts illuminating, there may be a delay in response or the command may not be executed. Try sending or receiving any command after 60 seconds.
- When transmitting multiple commands, be sure to wait until 0.5 seconds has elapsed after receiving the response from the projector before sending the next command. When transmitting a command which does not need a parameter, a colon (:) is not necessary.

**Note**

- If a command cannot be executed, the “ER401” response is sent from the projector to the computer.
- If an invalid parameter is sent, the “ER402” response is sent from the projector to the computer.
- ID transmission in RS-232C supports ZZ (ALL) and 01 to 64, as well as 0A to 0Z groups.
- If a command is sent with a specified ID, a response will be sent to the computer only in the following cases.
  - It matches the projector ID
  - ID setting is set to ALL and [RESPONSE(ID ALL)] is [ON]
  - ID setting is set to GROUP and [RESPONSE(ID GROUP)] is [ON]
- STX and ETX are character codes. STX shown in hexadecimal is 02, and ETX shown in hexadecimal is 03.

**When multiple projectors are controlled**

**When multiple projectors are all controlled**

When controlling multiple projectors together via RS-232C, perform the following settings.

- 1) Set a different ID for each projector.
- 2) Set [RESPONSE(ID ALL)] to [ON] in only one projector.
- 3) Set [RESPONSE(ID ALL)] to [OFF] for all other projectors set in Step 2).

**When multiple projectors are all controlled by group unit**

When controlling multiple projectors by group unit via RS-232C, perform the following settings.

- 1) Set a different ID for each projector.
- 2) Set [RESPONSE(ID GROUP)] to [ON] in only one projector.
- 3) Set [RESPONSE(ID GROUP)] to [OFF] for all other projectors set in Step 2).

**Note**

- There will be no response if two or more projectors have [RESPONSE(ID ALL)] set to [ON].
- There will be no response if two or more projectors of the same group have [RESPONSE(ID GROUP)] set to [ON].
- When setting multiple groups, set [RESPONSE(ID ALL)] to [ON] in only one projector in each group.

**Cable specification**

**When connected to a computer**

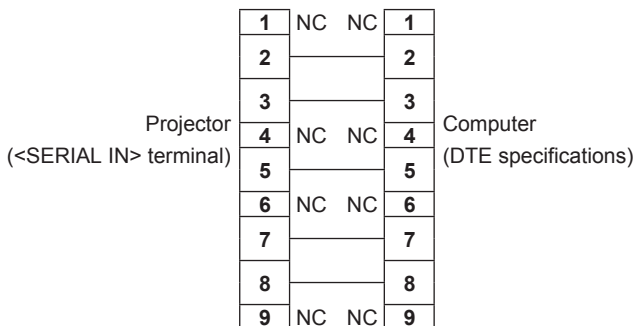

**When multiple projectors are connected**

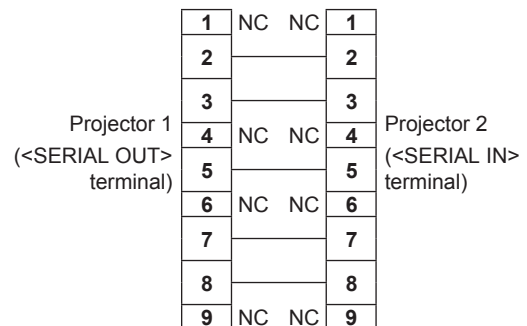

## Control command

The following table lists the commands that can be used to control the projector using a computer.

### ■ Projector control command

Command	Details	Parameter/response string	Remark (parameter)
PON	Power on	—	To check if the power is on, use the "Power query" command.
POF	Power standby		
QPW	Power query	000 001	STANDBY Power on
IIS	Switching the input signal	VID RG1 RG2 DVI HD1 DL1 SD1	VIDEO RGB1 RGB2 DVI-D HDMI DIGITAL LINK SDI (only for PT-DZ870E)
QSL	Query for lamp selection	0 1 2 3	DUAL SINGLE LAMP1 LAMP2
LPM	Lamp selection	0 1 2 3	DUAL SINGLE*1 LAMP1 LAMP2
Q\$L	Lamp cumulative runtime query	1 2	LAMP1 LAMP2 Response is 0000 to 4000
OLP	Lamp power	0 1	NORMAL ECO
OSH	Shutter	0	OPEN
QSH	Shutter status query	1	CLOSE
VSE	Aspect ratio switch	0 1 2 5	DEFAULT/MID AUTO 4:3 16:9 THROUGH
QSE	Aspect ratio settings query	6 9 10	HV FIT H FIT V FIT
OPP	P IN P execute	0 1 2 3	OFF USER1 USER2 USER3
QPP	P IN P setting query	0 1 2 3	OFF USER1 USER2 USER3
OCS	Sub memory switch	01 - 96	Sub memory number
QSB	Sub memory status query		

\*1 Use Lamp 1 or Lamp 2 whichever has a shorter runtime.

### ■ Projector control command (with sub command)

Command	Sub command	Details	Remark
VXX	RYC11	RGB1 input setting	+00000 = RGB/YP <sub>B</sub> P <sub>R</sub> , +00001 = Y/C

■ Lens control command

Command	Sub command	Details	Remark
VXX	LNSI2	Lens H shift	+00000 = Fine adjustment 1+, +00001 = Fine adjustment 1-, +00100 = Fine adjustment 2+, +00101 = Fine adjustment 2-, +00200 = Coarse adjustment+, +00201 = Coarse adjustment-
VXX	LNSI3	Lens V shift	
VXX	LNSI4	Lens focus	
VXX	LNSI5	Lens zoom	

<REMOTE 2 IN> terminal

It is possible to control the projector remotely (by external contact) from a control panel located away from the projector where remote control signals cannot reach.

Use the <REMOTE 2 IN> terminal on the connecting terminals of the projector to connect to the control panel.

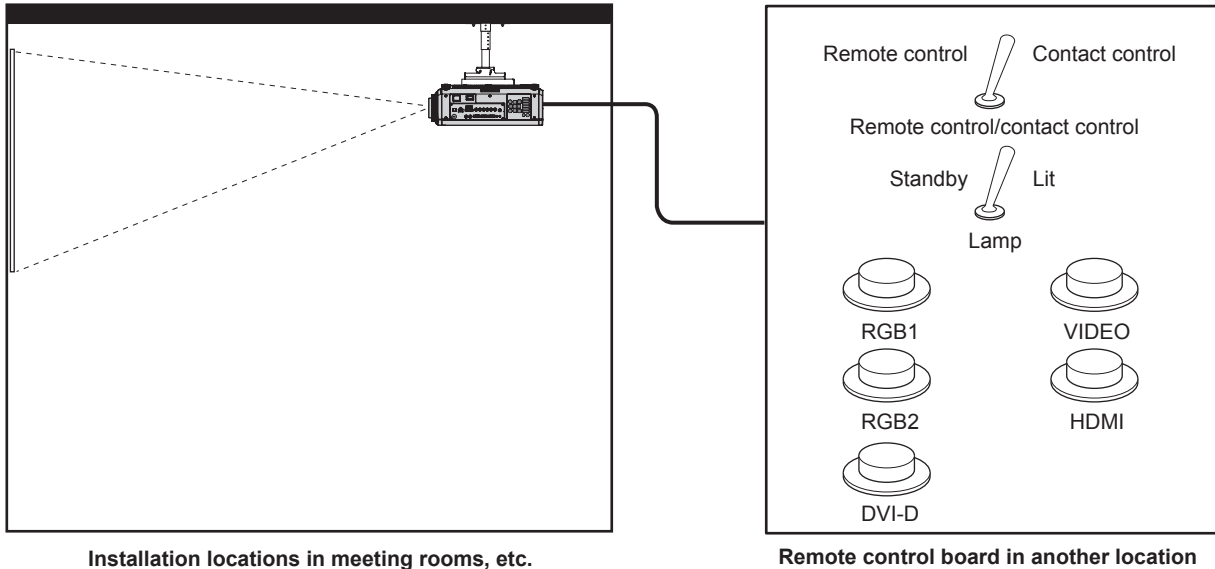

Installation locations in meeting rooms, etc.

Remote control board in another location

Pin assignments and signal names

D-Sub 9-pin Outside view	Pin No.	Signal name	Open (H)	Short (L)
	(1)	GND	—	GND
	(2)	POWER	OFF	ON
	(3)	RGB1	Other	RGB1
	(4)	RGB2	Other	RGB2
	(5)	VIDEO	Other	VIDEO
	(6)	HDMI	Other	HDMI
	(7)	DVI-D	Other	DVI-D
	(8)	SHUTTER	OFF	ON
	(9)	RST/SET	Controlled by remote control	Controlled by external contact

Attention

- When controlling, make sure to short-circuit pins (1) and (9).
- When pins (1) and (9) are short-circuited, the following buttons on the control panel and the remote control are disabled. Commands for RS-232C and network functions corresponding to these functions are also disabled.
  - Power on <|> button, power standby <ϕ> button, <SHUTTER> button
- When pins (1) and (9) are short-circuited, and then any pins from (3) to (7) and the pin (1) are short-circuited, the following buttons on the control panel and the remote control are disabled. Commands for RS-232C and network functions corresponding to these functions are also disabled.
  - Power on <|> button, power standby <ϕ> button, <RGB1/RGB2> button, <DVI-D> button, <VIDEO> button, <HDMI> button, <DIGITAL LINK> button, <SDI> button, <SHUTTER> button

Note

- For pin (2) to pin (8) settings, you can make changes if you set [REMOTE2 MODE] to [USER]. (➡ page 121)

## Two-window display combination list

Main window		Sub window					
		RGB1			RGB2		VIDEO input
		RGB	Movie <sup>*1</sup>	Y/C input	RGB	Movie <sup>*1</sup>	
RGB1	RGB	—	—	—	✓	✓	✓
	Movie <sup>*1</sup>	—	—	—	✓	▲	▲
	Y/C input	—	—	—	✓	▲	—
RGB2	RGB	✓	✓	✓	—	—	✓
	Movie <sup>*1</sup>	✓	▲	▲	—	—	▲
VIDEO input		✓	▲	—	✓	▲	—
DVI-D	RGB <sup>*2</sup>	✓	✓	✓	✓	✓	✓
	Movie <sup>*3</sup>	✓	▲	▲	✓	▲	▲
HDMI	RGB <sup>*2</sup>	✓	✓	✓	✓	✓	✓
	Movie <sup>*3</sup>	✓	▲	▲	✓	▲	▲
SDI		✓	▲	▲	✓	▲	▲
DIGITAL LINK	RGB <sup>*2</sup>	—	—	—	—	—	—
	Movie <sup>*3</sup>	—	—	—	—	—	—

Main window		Sub window						
		DVI-D		HDMI		SDI	DIGITAL LINK	
		RGB <sup>*2</sup>	Movie <sup>*3</sup>	RGB <sup>*2</sup>	Movie <sup>*3</sup>			RGB <sup>*2</sup>
RGB1	RGB	✓	✓	✓	✓	✓	—	—
	Movie <sup>*1</sup>	✓	▲	✓	▲	▲	—	—
	Y/C input	✓	▲	✓	▲	▲	—	—
RGB2	RGB	✓	✓	✓	✓	✓	—	—
	Movie <sup>*1</sup>	✓	▲	✓	▲	▲	—	—
VIDEO input		✓	▲	✓	▲	▲	—	—
DVI-D	RGB <sup>*2</sup>	—	—	✓	✓	✓	—	—
	Movie <sup>*3</sup>	—	—	✓	▲	▲	—	—
HDMI	RGB <sup>*2</sup>	✓	✓	—	—	—	—	—
	Movie <sup>*3</sup>	✓	▲	—	—	—	—	—
SDI		✓	▲	—	—	—	—	—
DIGITAL LINK	RGB <sup>*2</sup>	—	—	—	—	—	—	—
	Movie <sup>*3</sup>	—	—	—	—	—	—	—

✓: P IN P (picture in picture) combination is possible

▲: P IN P (picture in picture) combination is possible through the same frequency

—: P IN P (picture in picture) combination is not possible

\*1 480i, 480p, 576i, 576p, 720/60p, 720/50p, 1080/60i, 1080/50i, 1080/24sF, 1080/24p, 1080/25p, 1080/30p, 1080/50p, 1080/60p

\*2 VGA (640 x 480) - WUXGA (1 920 x 1 200)

Non-interlace signal, dot clock frequency: 25 MHz to 162 MHz (The WUXGA signal is only compatible with VESA CVT RB (Reduced Blanking) signals.)

\*3 Only supports 480p, 576p, 720/60p, 720/50p, 1080/60i, 1080/50i, 1080/24sF, 1080/24p, 1080/25p, 1080/30p, 1080/50p, and 1080/60p

## Control device password

To initialize your password, consult your distributor.

## Upgrade Kit

(Only for PT-DZ870E)

If the optional Upgrade Kit (Model No.: ET-UK20) is applied, the following functions are extended.

Function	Standard status	When the Upgrade Kit is applied
<b>Adjustment range of [VERTICAL KEYSTONE]</b>	Maximum of $\pm 40^{\circ*1}$	Maximum of $\pm 45^{\circ*1}$
<b>Adjustment range of [HORIZONTAL KEYSTONE]</b>	Maximum of $\pm 15^{\circ*1}$	Maximum of $\pm 40^{\circ*1}$
<b>Adjustment range of [CURVED]</b>	Vertical arc, Maximum $\pm 50^{\circ*1}$ Horizontal arc, Maximum $\pm 50^{\circ*1}$	Vertical arc, Maximum $\pm 100^{\circ*1}$ Horizontal arc, Maximum $\pm 100^{\circ*1}$
<b>[CUSTOM MASKING]</b>	Cannot be used.	The image can be masked in optional form.
<b>[PC CORRECTION] of [UNIFORMITY]</b>	Cannot be used.	The brightness and unevenness of color of the entire screen can be corrected.

\*1 The adjustment range of the menu. Refer to "[GEOMETRY(2D)] projection range" (➔ page 34) for the possible projection range.  
For details, refer to the Operating Instructions included in the CD-ROM of the optional Upgrade Kit (Model No.: ET-UK20).

## List of compatible signals

The following table specifies the video signals compatible with the projector.

- Symbols that indicate formats are as follows.
  - V: VIDEO, Y/C
  - R: RGB
  - Y: YC<sub>B</sub>C<sub>R</sub>/YP<sub>B</sub>P<sub>R</sub>
  - D: DVI-D
  - H: HDMI
  - S: SDI (only for PT-DZ870E)

Mode	Resolution (Dots)	Scanning freq.		Dot clock freq. (MHz)	Format	Plug and play*1				
		Horizontal (kHz)	Vertical (Hz)			RGB2	DVI-D			HDMI
						EDID1	EDID2	EDID3		
NTSC/NTSC4.43/ PAL-M/PAL60	720 x 480i	15.7	59.9	—	V	—	—	—	—	
PAL/PAL-N/SECAM	720 x 576i	15.6	50.0	—	V	—	—	—	—	
525i (480i)	720 x 480i	15.7	59.9	13.5	R/Y/S	—	—	—	—	
625i (576i)	720 x 576i	15.6	50.0	13.5	R/Y/S	—	—	—	—	
525i (480i)	720 (1440) x 480i <sup>2</sup>	15.7	59.9	27.0	D/H	—	—	—	—	
625i (576i)	720 (1440) x 576i <sup>2</sup>	15.6	50.0	27.0	D/H	—	—	—	—	
525p (480p)	720 x 483	31.5	59.9	27.0	R/Y/D/H	—	✓	—	✓	
625p (576p)	720 x 576	31.3	50.0	27.0	R/Y/D/H	—	✓	—	✓	
750 (720)/60p	1 280 x 720	45.0	60.0	74.3	R/Y/D/H/S	—	✓	—	✓	
750 (720)/50p	1 280 x 720	37.5	50.0	74.3	R/Y/D/H/S	—	✓	—	✓	
1125 (1080)/60i <sup>3</sup>	1 920 x 1 080i	33.8	60.0	74.3	R/Y/D/H/S	—	✓	—	✓	
1125 (1080)/50i	1 920 x 1 080i	28.1	50.0	74.3	R/Y/D/H/S	—	✓	—	✓	
1125 (1080)/24p	1 920 x 1 080	27.0	24.0	74.3	R/Y/D/H/S	—	✓	—	✓	
1125 (1080)/24sF	1 920 x 1 080i	27.0	48.0	74.3	R/Y/D/H/S	—	—	—	—	
1125 (1080)/25p	1 920 x 1 080	28.1	25.0	74.3	R/Y/D/H/S	—	✓	—	✓	
1125 (1080)/30p	1 920 x 1 080	33.8	30.0	74.3	R/Y/D/H/S	—	—	—	—	
1125 (1080)/60p	1 920 x 1 080	67.5	60.0	148.5	R/Y/D/H/S	—	✓	—	✓	
1125 (1080)/50p	1 920 x 1 080	56.3	50.0	148.5	R/Y/D/H/S	—	✓	—	✓	
VESA400	640 x 400	31.5	70.1	25.2	R/D/H	—	—	—	—	
	640 x 400	37.9	85.1	31.5	R/D/H	—	—	—	—	
VGA480	640 x 480	31.5	59.9	25.2	R/D/H	✓	✓	✓	✓	
	640 x 480	35.0	66.7	30.2	R/D/H	—	—	—	—	
	640 x 480	37.9	72.8	31.5	R/D/H	✓	—	✓	✓	
	640 x 480	37.5	75.0	31.5	R/D/H	✓	—	✓	✓	
	640 x 480	43.3	85.0	36.0	R/D/H	—	—	—	—	

Chapter 6 Appendix — Technical information

Mode	Resolution (Dots)	Scanning freq.		Dot clock freq. (MHz)	Format	Plug and play <sup>*1</sup>				
		Horizontal (kHz)	Vertical (Hz)			RGB2	DVI-D			HDMI
							EDID1	EDID2	EDID3	
SVGA	800 x 600	35.2	56.3	36.0	R/D/H	✓	—	✓	✓	✓
	800 x 600	37.9	60.3	40.0	R/D/H	✓	—	✓	✓	✓
	800 x 600	48.1	72.2	50.0	R/D/H	✓	—	✓	✓	✓
	800 x 600	46.9	75.0	49.5	R/D/H	✓	—	✓	✓	✓
	800 x 600	53.7	85.1	56.3	R/D/H	—	—	—	—	—
MAC16	832 x 624	49.7	74.6	57.3	R/D/H	✓	—	✓	✓	✓
XGA	1 024 x 768	39.6	50.0	51.9	R/D/H	—	—	—	—	—
	1 024 x 768	48.4	60.0	65.0	R/D/H	✓	—	✓	✓	✓
	1 024 x 768	56.5	70.1	75.0	R/D/H	✓	—	✓	✓	✓
	1 024 x 768	60.0	75.0	78.8	R/D/H	✓	—	✓	✓	✓
	1 024 x 768	65.5	81.6	86.0	R/D/H	—	—	—	—	—
	1 024 x 768	68.7	85.0	94.5	R/D/H	—	—	—	—	—
	1 024 x 768	81.4	100.0	113.3	R/D/H <sup>*4</sup>	—	—	—	—	—
	1 024 x 768	98.8	120.0	139.1	R/D/H <sup>*4</sup>	✓	—	✓	✓	✓
MXGA	1 152 x 864	53.7	60.0	81.6	R/D/H	—	—	—	—	—
	1 152 x 864	64.0	70.0	94.2	R/D/H	—	—	—	—	—
	1 152 x 864	67.5	74.9	108.0	R/D/H	—	—	—	—	—
	1 152 x 864	77.1	85.0	119.7	R/D/H	—	—	—	—	—
MAC21	1 152 x 870	68.7	75.1	100.0	R/D/H	✓	—	✓	✓	✓
1280 x 720	1 280 x 720	37.1	49.8	60.5	R/D/H	—	—	—	—	—
	1 280 x 720	44.8	59.9	74.5	R/D/H	—	—	—	—	—
	1 280 x 720	76.3	100.0	131.8	R/D/H <sup>*4</sup>	—	—	—	—	—
	1 280 x 720	92.6	120.0	161.6	R/D/H <sup>*4</sup>	—	—	—	—	—
1280 x 768	1 280 x 768	39.6	49.9	65.3	R/D/H	—	—	—	—	—
	1 280 x 768	47.8	59.9	79.5	R/D/H	—	—	—	—	—
	1 280 x 768 <sup>*5</sup>	47.4	60.0	68.3	R/D/H	—	—	—	—	—
	1 280 x 768	60.3	74.9	102.3	R/D/H	—	—	—	—	—
	1 280 x 768	68.6	84.8	117.5	R/D/H	—	—	—	—	—
1280 x 800	1 280 x 800	41.3	50.0	68.0	R/D/H	—	—	—	—	—
	1 280 x 800	49.7	59.8	83.5	R/D/H	✓ <sup>*6</sup>	—	✓ <sup>*6</sup>	✓ <sup>*6</sup>	✓ <sup>*6</sup>
	1 280 x 800 <sup>*5</sup>	49.3	59.9	71.0	R/D/H	—	—	—	—	—
	1 280 x 800	62.8	74.9	106.5	R/D/H	—	—	—	—	—
	1 280 x 800	71.6	84.9	122.5	R/D/H	—	—	—	—	—
MSXGA	1 280 x 960	60.0	60.0	108.0	R/D/H	—	—	—	—	—
SXGA	1 280 x 1 024	52.4	50.0	88.0	R/D/H	—	—	—	—	—
	1 280 x 1 024	64.0	60.0	108.0	R/D/H	✓	—	✓	✓	✓
	1 280 x 1 024	72.3	66.3	125.0	R/D/H	—	—	—	—	—
	1 280 x 1 024	78.2	72.0	135.1	R/D/H	—	—	—	—	—
	1 280 x 1 024	80.0	75.0	135.0	R/D/H	✓	—	✓	✓	✓
1366 x 768	1 366 x 768	47.7	59.8	85.5	R/D/H	—	—	—	—	—
	1 366 x 768	39.6	49.9	69.0	R/D/H	—	—	—	—	—
SXGA+	1 400 x 1 050	54.1	50.0	99.9	R/D/H	—	—	—	—	—
	1 400 x 1 050	64.0	60.0	108.0	R/D/H	—	—	—	—	—
	1 400 x 1 050	65.2	60.0	122.6	R/D/H	✓	—	✓	✓	✓
	1 400 x 1 050	65.3	60.0	121.8	R/D/H	—	—	—	—	—
	1 400 x 1 050	78.8	72.0	149.3	R/D/H	—	—	—	—	—
	1 400 x 1 050	82.2	75.0	155.9	R/D/H	—	—	—	—	—
WXGA+	1 440 x 900	55.9	59.9	106.5	R/D/H	—	—	—	—	—
	1 440 x 900	46.3	49.9	86.8	R/D/H	—	—	—	—	—
UXGA60	1 600 x 1 200	75.0	60.0	162.0	R/D/H	✓	—	✓	✓	✓
WSXGA+	1 680 x 1 050	65.3	60.0	146.3	R/D/H	—	—	—	—	—
	1 680 x 1 050	54.1	50.0	119.5	R/D/H	—	—	—	—	—

Mode	Resolution (Dots)	Scanning freq.		Dot clock freq. (MHz)	Format	Plug and play <sup>*1</sup>				
		Horizontal (kHz)	Vertical (Hz)			RGB2	DVI-D			HDMI
							EDID1	EDID2	EDID3	
1920 x 1080	1 920 x 1 080	55.6	49.9	141.5	R/D/H	—	—	—	—	—
	1 920 x 1 080 <sup>*5</sup>	66.6	59.9	138.5	R/D/H	—	—	—	—	—
	1 920 x 1 080 <sup>*7</sup>	67.2	60.0	173.0	R	—	—	—	—	—
WUXGA	1 920 x 1 200	61.8	49.9	158.3	R/D/H	—	—	—	—	—
	1 920 x 1 200 <sup>*5</sup>	74.0	60.0	154.0	R/D/H	✓	—	✓	✓ <sup>*8</sup>	✓ <sup>*8</sup>
	1 920 x 1 200 <sup>*7</sup>	74.6	59.9	193.3	R	—	—	—	—	—

- \*1 Signals with ✓ in the Plug and play columns are signals described in EDID (extended display identification data) of the projector. A signal, which has no ✓ in the Plug and play columns but has an entry in the Format column, can be input. For signals without ✓ in the Plug and play columns, resolution may not be selected in the computer even though the projector supports them.
- \*2 Pixel-Repetition signal (dot clock frequency 27.0 MHz) only
- \*3 When a 1125 (1035)/60i signal was input, it is displayed as a 1125 (1080)/60i signal.
- \*4 When [3D INPUT FORMAT] is set to [AUTO], 3D images in frame sequential format are displayed. To display images in 2D, set [3D INPUT FORMAT] to [NATIVE].
- \*5 VESA CVT-RB (Reduced Blanking)-compliant
- \*6 Only for PT-DW830E
- \*7 Samples the pixels in the image processing circuit and projects the image.
- \*8 Only for PT-DZ870E

**Note**

- The display dot for PT-DZ870E is 1 920 x 1 200, the display dot for PT-DW830E is 1 280 x 800, and the display dot for PT-DX100E is 1 024 x 768. A signal with a different resolution is converted to the number of display dots.
- The “i” at the end of the resolution indicates an interlaced signal.
- When interlaced signals are connected, flickering may occur on the projected image.
- DIGITAL LINK input compatible signal is the same as HDMI input compatible signal.

**List of 3D compatible signals**

The following table specifies the 3D compatible video signals that the projector can project.

- Abbreviations for input formats and 3D formats in the table have the following meanings.
  - FP: Frame packing system
  - SBS: Side by side system
  - TB: Top and bottom system
  - LBL: Line by line system
  - FS: Frame sequential system
  - 3G: 3G-SDI Level B simultaneous system
  - H-D: HDMI & DVI-D Input simultaneous system
  - R1-2: RGB1 & RGB2 Input simultaneous system

3D compatible signal	Resolution (Dots)	Scanning freq.		Dot clock freq. (MHz)	HDMI				DVI-D			
		Horizontal (kHz)	Vertical (Hz)		FP	SBS <sup>*1</sup>	TB	FS	SBS <sup>*1</sup>	TB	LBL	FS
750 (720)/60p	1 280 x 720	45.0	60.0	74.3	✓	✓	✓	—	✓	✓	✓	—
750 (720)/50p	1 280 x 720	37.5	50.0	74.3	✓	✓	✓	—	✓	✓	✓	—
1080/60i	1 920 x 1 080i	33.8	60.0	74.3	✓	✓	—	—	✓	✓	—	—
1080/50i	1 920 x 1 080i	28.1	50.0	74.3	✓	✓	—	—	✓	✓	—	—
1080/24p	1 920 x 1 080	27.0	24.0	74.3	✓	✓	✓	—	✓	✓	—	—
1080/24sF	1 920 x 1 080i	27.0	48.0	74.3	—	—	—	—	✓	✓	—	—
1080/25p	1 920 x 1 080	28.1	25.0	74.3	—	—	—	—	✓	✓	—	—
1080/30p	1 920 x 1 080	33.8	30.0	74.3	—	—	—	—	✓	✓	—	—
1080/60p	1 920 x 1 080	67.5	60.0	148.5	—	✓	✓	—	✓	✓	—	—
1080/50p	1 920 x 1 080	56.3	50.0	148.5	—	✓	✓	—	✓	✓	—	—
VGA480	640 x 480	31.5	59.9	25.2	—	—	—	—	✓	—	—	—
SVGA	800 x 600	37.9	60.3	40.0	—	—	—	—	✓	—	—	—
XGA	1 024 x 768	39.6	50.0	51.9	—	—	—	—	✓	—	—	—
	1 024 x 768	48.4	60.0	65.0	—	—	—	—	✓	—	—	—
	1 024 x 768	81.4	100.0	113.3	—	—	—	✓	—	—	—	✓
	1 024 x 768	98.8	120.0	139.1	—	—	—	✓	—	—	—	✓
MXGA	1 152 x 864	53.7	60.0	81.6	—	—	—	—	✓	—	—	—



Chapter 6 Appendix — Technical information

3D compatible signal	Resolution (Dots)	Scanning freq.		Dot clock freq. (MHz)	HDMI				DVI-D			
		Horizontal (kHz)	Vertical (Hz)		FP	SBS*1	TB	FS	SBS*1	TB	LBL	FS
1280 x 720	1 280 x 720	37.1	49.8	60.5	—	—	—	—	✓	—	—	—
	1 280 x 720	44.8	59.9	74.5	—	—	—	—	✓	—	—	—
	1 280 x 720	76.3	100.0	131.8	—	—	—	✓	—	—	—	✓
	1 280 x 720	92.6	120.0	161.6	—	—	—	✓	—	—	—	✓
1280 x 768	1 280 x 768	39.6	49.9	65.3	—	—	—	—	✓	—	—	—
	1 280 x 768	47.8	59.9	79.5	—	—	—	—	✓	—	—	—
	1 280 x 768 <sup>*2</sup>	47.4	60.0	68.3	—	—	—	—	✓	—	—	—
1280 x 800	1 280 x 800	41.3	50.0	68.0	—	—	—	—	✓	—	—	—
	1 280 x 800	49.7	59.8	83.5	—	—	—	—	✓	—	—	—
	1 280 x 800 <sup>*2</sup>	49.3	59.9	71.0	—	—	—	—	✓	—	—	—
MSXGA	1 280 x 960	60.0	60.0	108.0	—	—	—	—	✓	—	—	—
SXGA	1 280 x 1 024	52.4	50.0	88.0	—	—	—	—	✓	—	—	—
	1 280 x 1 024	64.0	60.0	108.0	—	—	—	—	✓	—	—	—
1366 x 768	1 366 x 768	47.7	59.8	85.5	—	—	—	—	✓	—	—	—
	1 366 x 768	39.6	49.9	69.0	—	—	—	—	✓	—	—	—
SXGA+	1 400 x 1 050	54.1	50.0	99.9	—	—	—	—	✓	—	—	—
	1 400 x 1 050	64.0	60.0	108.0	—	—	—	—	✓	—	—	—
	1 400 x 1 050	65.2	60.0	122.6	—	—	—	—	✓	—	—	—
	1 400 x 1 050	65.3	60.0	121.8	—	—	—	—	✓	—	—	—
WXGA+	1 440 x 900	55.9	59.9	106.5	—	—	—	—	✓	—	—	—
	1 440 x 900	46.3	49.9	86.8	—	—	—	—	✓	—	—	—
UXGA60	1 600 x 1 200	75.0	60.0	162.0	—	—	—	—	✓	—	—	—
WSXGA+	1 680 x 1 050	65.3	60.0	146.3	—	—	—	—	✓	—	—	—
	1 680 x 1 050	54.1	50.0	119.5	—	—	—	—	✓	—	—	—
1920 x 1080	1 920 x 1 080	55.6	49.9	141.5	—	—	—	—	✓	—	—	—
	1 920 x 1 080 <sup>*2</sup>	66.6	59.9	138.5	—	—	—	—	✓	—	—	—
WUXGA	1 920 x 1 200	61.8	49.9	158.3	—	—	—	—	✓	—	—	—
	1 920 x 1 200 <sup>*2</sup>	74.0	60.0	154.0	—	—	—	—	✓	—	✓	—

\*1 Supports half.

\*2 VESA CVT RB (Reduced Blanking)-compliant

## Chapter 6 Appendix — Technical information

3D compatible signal	Resolution (Dots)	Scanning freq.		Dot clock freq. (MHz)	RGB1/RGB2				SDI <sup>*1</sup>				H-D	R1-2
		Horizontal (kHz)	Vertical (Hz)		SBS <sup>*2</sup>	TB	LBL	FS	SBS <sup>*2</sup>	TB	LBL	3G		
750 (720)/60p	1 280 x 720	45.0	60.0	74.3	✓	✓	✓	—	✓	✓	✓	✓	✓	✓
750 (720)/50p	1 280 x 720	37.5	50.0	74.3	✓	✓	✓	—	✓	✓	✓	✓	✓	✓
1080/60i	1 920 x 1 080i	33.8	60.0	74.3	✓	✓	—	—	✓	✓	—	✓	✓	✓
1080/50i	1 920 x 1 080i	28.1	50.0	74.3	✓	✓	—	—	✓	✓	—	✓	✓	✓
1080/24p	1 920 x 1 080	27.0	24.0	74.3	✓	✓	—	—	✓	✓	—	✓	✓	✓
1080/24sF	1 920 x 1 080i	27.0	48.0	74.3	✓	✓	—	—	✓	✓	—	✓	✓	✓
1080/25p	1 920 x 1 080	28.1	25.0	74.3	✓	✓	—	—	✓	✓	—	✓	✓	✓
1080/30p	1 920 x 1 080	33.8	30.0	74.3	✓	✓	—	—	✓	✓	—	✓	✓	✓
1080/60p	1 920 x 1 080	67.5	60.0	148.5	✓	✓	—	—	✓	✓	—	—	✓	✓
1080/50p	1 920 x 1 080	56.3	50.0	148.5	✓	✓	—	—	✓	✓	—	—	✓	✓
VGA480	640 x 480	31.5	59.9	25.2	✓	—	—	—	—	—	—	—	—	—
SVGA	800 x 600	37.9	60.3	40.0	✓	—	—	—	—	—	—	—	—	—
XGA	1 024 x 768	39.6	50.0	51.9	✓	—	—	—	—	—	—	—	✓	✓
	1 024 x 768	48.4	60.0	65.0	✓	—	—	—	—	—	—	—	✓	✓
	1 024 x 768	81.4	100.0	113.3	—	—	—	✓	—	—	—	—	—	—
	1 024 x 768	98.8	120.0	139.1	—	—	—	✓	—	—	—	—	—	—
MXGA	1 152 x 864	53.7	60.0	81.6	✓	—	—	—	—	—	—	—	—	—
1280 x 720	1 280 x 720	37.1	49.8	60.5	✓	—	—	—	—	—	—	—	—	—
	1 280 x 720	44.8	59.9	74.5	✓	—	—	—	—	—	—	—	—	—
	1 280 x 720	76.3	100.0	131.8	—	—	—	✓	—	—	—	—	—	—
	1 280 x 720	92.6	120.0	161.6	—	—	—	✓	—	—	—	—	—	—
1280 x 768	1 280 x 768	39.6	49.9	65.3	✓	—	—	—	—	—	—	—	—	—
	1 280 x 768	47.8	59.9	79.5	✓	—	—	—	—	—	—	—	—	—
	1 280 x 768 <sup>*3</sup>	47.4	60.0	68.3	✓	—	—	—	—	—	—	—	—	—
1280 x 800	1 280 x 800	41.3	50.0	68.0	✓	—	—	—	—	—	—	—	✓	✓
	1 280 x 800	49.7	59.8	83.5	✓	—	—	—	—	—	—	—	✓	✓
	1 280 x 800 <sup>*3</sup>	49.3	59.9	71.0	✓	—	—	—	—	—	—	—	✓	✓
MSXGA	1 280 x 960	60.0	60.0	108.0	✓	—	—	—	—	—	—	—	—	—
SXGA	1 280 x 1 024	52.4	50.0	88.0	✓	—	—	—	—	—	—	—	—	—
	1 280 x 1 024	64.0	60.0	108.0	✓	—	—	—	—	—	—	—	—	—
1366 x 768	1 366 x 768	47.7	59.8	85.5	✓	—	—	—	—	—	—	—	—	—
	1 366 x 768	39.6	49.9	69.0	✓	—	—	—	—	—	—	—	—	—
SXGA+	1 400 x 1 050	54.1	50.0	99.9	✓	—	—	—	—	—	—	—	—	—
	1 400 x 1 050	64.0	60.0	108.0	✓	—	—	—	—	—	—	—	—	—
	1 400 x 1 050	65.2	60.0	122.6	✓	—	—	—	—	—	—	—	—	—
	1 400 x 1 050	65.3	60.0	121.8	✓	—	—	—	—	—	—	—	—	—
WXGA+	1 440 x 900	55.9	59.9	106.5	✓	—	—	—	—	—	—	—	—	—
	1 440 x 900	46.3	49.9	86.8	✓	—	—	—	—	—	—	—	—	—
UXGA60	1 600 x 1 200	75.0	60.0	162.0	✓	—	—	—	—	—	—	—	—	—
WSXGA+	1 680 x 1 050	65.3	60.0	146.3	✓	—	—	—	—	—	—	—	—	—
	1 680 x 1 050	54.1	50.0	119.5	✓	—	—	—	—	—	—	—	—	—
1920 x 1080	1 920 x 1 080	55.6	49.9	141.5	✓	—	—	—	—	—	—	—	—	—
	1 920 x 1 080 <sup>*3</sup>	66.6	59.9	138.5	✓	—	—	—	—	—	—	—	—	—
WUXGA	1 920 x 1 200	61.8	49.9	158.3	✓	—	—	—	—	—	—	—	✓	✓
	1 920 x 1 200 <sup>*3</sup>	74.0	60.0	154.0	✓	—	✓	—	—	—	—	—	✓	✓

\*1 Only for PT-DZ870E

\*2 Supports half.

\*3 VESA CVT RB (Reduced Blanking)-compliant

### Note

- DIGITAL LINK input compatible signal is the same as HDMI input compatible signal.

# Specifications

The specifications of the projector are as follows.

<b>Power supply</b>		AC 120 V - 240 V, 50 Hz/60 Hz	
<b>Power consumption</b>		1 030 W (10 A - 5.2 A)	
		0.3 W when [STANDBY MODE] is set to [ECO]	
		3 W when [STANDBY MODE] is set to [NORMAL]	
<b>DLP chip</b>	<b>Size</b>	<b>PT-DZ870E</b>	17 mm (0.67") (aspect ratio 16:10)
		<b>PT-DW830E</b>	16.5 mm (0.65") (aspect ratio 16:10)
		<b>PT-DX100E</b>	17.8 mm (0.7") (aspect ratio 4:3)
	<b>Display system</b>	1-unit DLP chip, DLP type	
<b>Number of pixels</b>	<b>PT-DZ870E</b>	2 304 000 pixels (1 920 x 1 200 dots)	
	<b>PT-DW830E</b>	1 024 000 pixels (1 280 x 800 dots)	
	<b>PT-DX100E</b>	786 432 pixels (1 024 x 768 dots)	
<b>Lens*1</b>	<b>Electric zoom</b>	<b>PT-DZ870E</b>	1.7 - 2.4:1
		<b>PT-DW830E, PT-DX100E</b>	1.8 - 2.5:1
	<b>Electric focus</b>	F = 1.7 - 1.9 f = 25.6 mm - 35.7 mm	
<b>Luminous lamp</b>		420 W UHM lamp x 2	
<b>Light output*2,3</b>		<b>PT-DZ870E, PT-DW830E</b>	8 500 lm(ANSI)
		<b>PT-DX100E</b>	10 000 lm(ANSI)
<b>Contrast ratio*3</b>		10 000:1 (when [DYNAMIC IRIS] is set to [3])	
<b>Color system</b>		7 standards (NTSC/NTSC4.43/PAL/PAL-N/PAL-M/SECAM/PAL60)	
<b>Projection screen size*4</b>		1.27 m (50") to 15.24 m (600")	
<b>Screen aspect ratio</b>		<b>PT-DZ870E, PT-DW830E</b>	16:10
		<b>PT-DX100E</b>	4:3
<b>Projection method</b>		[FRONT/CEILING], [FRONT/FLOOR], [REAR/CEILING], [REAR/FLOOR]	
<b>Power cable length</b>		3.0 m (118-1/8")	
<b>Outer case</b>		Molded plastic	
<b>Dimensions</b>	<b>Width</b>	498 mm (19-19/32")	
	<b>Height</b>	200 mm (7-7/8") (with legs at shortest position)	
	<b>Depth</b>	<b>PT-DZ870E, PT-DW830E, PT-DX100E</b>	556 mm (21-7/8") (including standard zoom lens)
<b>PT-DZ870EL, PT-DW830EL, PT-DX100EL</b>		513 mm (20-3/16") (excluding optional lens)	
<b>Weight</b>	<b>PT-DZ870E, PT-DW830E, PT-DX100E</b>	Approx. 18.3 kg (40 lbs.) <sup>*5</sup> (including standard zoom lens)	
	<b>PT-DZ870EL, PT-DW830EL, PT-DX100EL</b>	Approx. 17.6 kg (38.8 lbs.) <sup>*5</sup> (excluding optional lens)	
<b>Noise level*3</b>		40 dB	
<b>Operating environment</b>	<b>Operating environment temperature*6</b>	0 °C (32 °F) to 45 °C (113 °F)	
	<b>Operating environment humidity</b>	10 % - 80 % (No condensation)	
<b>Remote control</b>	<b>Power supply</b>	DC 3 V (AAA/R03 battery x 2)	
	<b>Operating range</b>	Within approx. 30 m (98'5") (when operated directly in front of signal receiver)	
	<b>Weight</b>	102 g (3.6 oz.) (including batteries)	
	<b>Dimensions</b>	Width: 48 mm (1-7/8"), Height: 145 mm (5-23/32"), Depth: 27 mm (1-1/16")	

\*1 For PT-DZ870EL, PT-DW830EL, and PT-DX100EL, lenses are optional accessories.

\*2 Value is for the supplied standard zoom lens. The value varies depending on the lens.

\*3 Measurement, measuring conditions and method of notation all comply with ISO21118 international standards.

\*4 When the ET-DLE055 lens is used, the maximum size is 5.08 m (200").

\*5 Average value. Weight varies for each product.

\*6 When using the projector at high altitudes (1 400 m (4 593') or higher – lower than 2 700 m (8 858') above sea level), the operating environment temperature should be between 0 °C (32 °F) - 40 °C (104 °F).

If the [PROJECTOR SETUP] menu → [LAMP SELECT] is set to [DUAL], and [LAMP POWER] is set to [NORMAL], and the operating environment temperature reaches 40 °C (104 °F) or higher (35 °C (95 °F) or higher when [HIGH ALTITUDE MODE] is set to [ON]), the light output may drop by approx. 20 % to protect the projector.

■ **Applicable scanning frequency**

Refer to “List of compatible signals” (➡ page 178) for the types of video signals that can be used with the projector.

<b>For video signal (including Y/C signal)</b>	Horizontal: 15.75 kHz/15.63 kHz, Vertical: 50 Hz/60 Hz	
<b>For RGB signal</b>	Horizontal: 15 kHz to 100 kHz, Vertical: 24 Hz to 120 Hz PIAS (Panasonic Intelligent Auto Scanning) system	
<b>For YC<sub>B</sub>C<sub>R</sub>/YP<sub>B</sub>P<sub>R</sub> signal</b>	<ul style="list-style-type: none"> <li>• Dot clock frequency: 162 MHz or less</li> <li>• 525i (480i) Horizontal: 15.75 kHz, Vertical: 60 Hz</li> <li>• 525p (480p) Horizontal: 31.5 kHz, Vertical: 60 Hz</li> <li>• 750 (720)/60p Horizontal: 45 kHz, Vertical: 60 Hz</li> <li>• 1125 (1035)/60i Horizontal: 33.75 kHz, Vertical: 60 Hz</li> <li>• 1125 (1080)/50i Horizontal: 28.13 kHz, Vertical: 50 Hz</li> <li>• 1125 (1080)/24sF Horizontal: 27 kHz, Vertical: 48 Hz</li> <li>• 1125 (1080)/30p Horizontal: 33.75 kHz, Vertical: 30 Hz</li> <li>• 1125 (1080)/50p Horizontal: 56.25 kHz, Vertical: 50 Hz</li> <li>• The SYNC/HD and VD terminals do not support 3 value SYNC.</li> </ul>	<ul style="list-style-type: none"> <li>• 625i (576i) Horizontal: 15.63 kHz, Vertical: 50 Hz</li> <li>• 625p (576p) Horizontal: 31.25 kHz, Vertical: 50 Hz</li> <li>• 750 (720)/50p Horizontal: 37.5 kHz, Vertical: 50 Hz</li> <li>• 1125 (1080)/60i Horizontal: 33.75 kHz, Vertical: 60 Hz</li> <li>• 1125 (1080)/24p Horizontal: 27 kHz, Vertical: 24 Hz</li> <li>• 1125 (1080)/25p Horizontal: 28.13 kHz, Vertical: 25 Hz</li> <li>• 1125 (1080)/60p Horizontal: 67.5 kHz, Vertical: 60 Hz</li> </ul>
<b>For DVI-D signal</b>	525i (480i)*1, 625i (576i)*1, 525p (480p), 625p (576p), 750 (720)/60p, 750 (720)/50p, 1125 (1080)/60i, 1125 (1080)/50i, 1125 (1080)/24p, 1125 (1080)/24sF, 1125 (1080)/25p, 1125 (1080)/30p, 1125 (1080)/60p, 1125 (1080)/50p	
	<ul style="list-style-type: none"> <li>• Displayable resolution: VGA to WUXGA (non-interlaced)</li> <li>• Dot clock frequency: 25 MHz to 162 MHz</li> </ul>	
<b>For HDMI signal</b>	525i (480i)*1, 625i (576i)*1, 525p (480p), 625p (576p), 750 (720)/60p, 750 (720)/50p, 1125 (1080)/60i, 1125 (1080)/50i, 1125 (1080)/24p, 1125 (1080)/24sF, 1125 (1080)/25p, 1125 (1080)/30p, 1125 (1080)/60p, 1125 (1080)/50p	
	<ul style="list-style-type: none"> <li>• Displayable resolution: VGA to WUXGA (non-interlaced)</li> <li>• Dot clock frequency: 25 MHz to 162 MHz</li> </ul>	
<b>For SDI signal (Only for PT-DZ870E)</b>	<b>SD-SDI signal</b>	SMPTE ST 259 compliant YC <sub>B</sub> C <sub>R</sub> 4:2:2 10-bit 480i, 576i
	<b>Single link HD-SDI signal</b>	SMPTE ST 292 compliant YP <sub>B</sub> P <sub>R</sub> 4:2:2 10-bit 720/50p, 720/60p, 1035/60i, 1080/50i, 1080/60i, 1080/25p, 1080/24p, 1080/24sF, 1080/30p
	<b>3G-SDI signal</b>	SMPTE ST 424 compliant YP <sub>B</sub> P <sub>R</sub> 4:2:2 10-bit 1080/50p, 1080/60p RGB 4:4:4 12-bit/10-bit 1080/50i, 1080/60i, 1080/25p, 1080/24p, 1080/24sF, 1080/30p

\*1 Pixel-Repetition signal (dot clock frequency 27.0 MHz) only

**Note**

- DIGITAL LINK input compatible signal is the same as HDMI input compatible signal.

■ Terminal

<b>&lt;RGB 1 IN&gt; terminal</b>	1 set (BNC x 5 (RGB/YP <sub>B</sub> P <sub>R</sub> /YC <sub>B</sub> C <sub>R</sub> /YC x 1)) <b>RGB signal</b> 0.7 V [p-p] 75 Ω (SYNC ON GREEN: 1.0 V [p-p] 75 Ω) SYNC/HD TTL high impedance, automatic positive/negative polarity compatible VD TTL high impedance, automatic positive/negative polarity compatible <b>YP<sub>B</sub>P<sub>R</sub> signal</b> Y: 1.0 V [p-p] including synchronization signal, P <sub>B</sub> P <sub>R</sub> : 0.7 V [p-p] 75 Ω <b>Y/C signal</b> Y: 1.0 V [p-p], C: 0.286 V [p-p] 75 Ω
<b>&lt;RGB 2 IN&gt; terminal</b>	1 set, high-density D-Sub 15 p (female) <b>RGB signal</b> 0.7 V [p-p] 75 Ω (SYNC ON GREEN: 1.0 V [p-p] 75 Ω) SYNC/HD TTL high impedance, automatic positive/negative polarity compatible VD TTL high impedance, automatic positive/negative polarity compatible <b>YP<sub>B</sub>P<sub>R</sub> signal</b> Y: 1.0 V [p-p] including synchronization signal, P <sub>B</sub> P <sub>R</sub> : 0.7 V [p-p] 75 Ω
<b>&lt;DVI-D IN&gt; terminal</b>	1 set, DVI-D 24 p, single link DVI 1.0 compliant, HDCP compatible
<b>&lt;HDMI IN&gt; terminal</b>	1 set, HDMI 19 pin, HDCP compatible, Deep Color compatible
<b>&lt;VIDEO IN&gt; terminal</b>	1 set, BNC 1.0 V [p-p] 75 Ω
<b>&lt;SDI IN&gt; terminal (Only for PT-DZ870E)</b>	1 set (BNC) <b>SD-SDI signal</b> SMPTE ST 259 compliant <b>HD-SDI signal</b> SMPTE ST 292 compliant <b>3G-SDI signal</b> SMPTE ST 424 compliant
<b>&lt;3D SYNC 1 IN/OUT&gt; terminal</b>	1 set (BNC) During input setting TTL high impedance During output setting TTL output: Maximum 10 mA
<b>&lt;3D SYNC 2 OUT&gt; terminal</b>	1 set (BNC) TTL output: Maximum 10 mA
<b>&lt;SERIAL IN&gt;/ &lt;SERIAL OUT&gt; terminal</b>	D-Sub 9 p, 1 set each, RS-232C compliant, for computer control
<b>&lt;REMOTE 1 IN&gt;/ &lt;REMOTE 1 OUT&gt; terminal</b>	M3 stereo mini jack cable, 1 set each, for remote control (wired)/projector link control
<b>&lt;REMOTE 2 IN&gt; terminal</b>	1 set, D-Sub 9 p, for external control
<b>&lt;DIGITAL LINK/LAN&gt; terminal</b>	1 set, RJ-45 network, for DIGITAL LINK connection, PJLink compatible, 100Base-TX, Art-Net compatible

**Note**

- The model numbers of accessories and optional components are subject to change without prior notice.

# Dimensions

Unit: mm

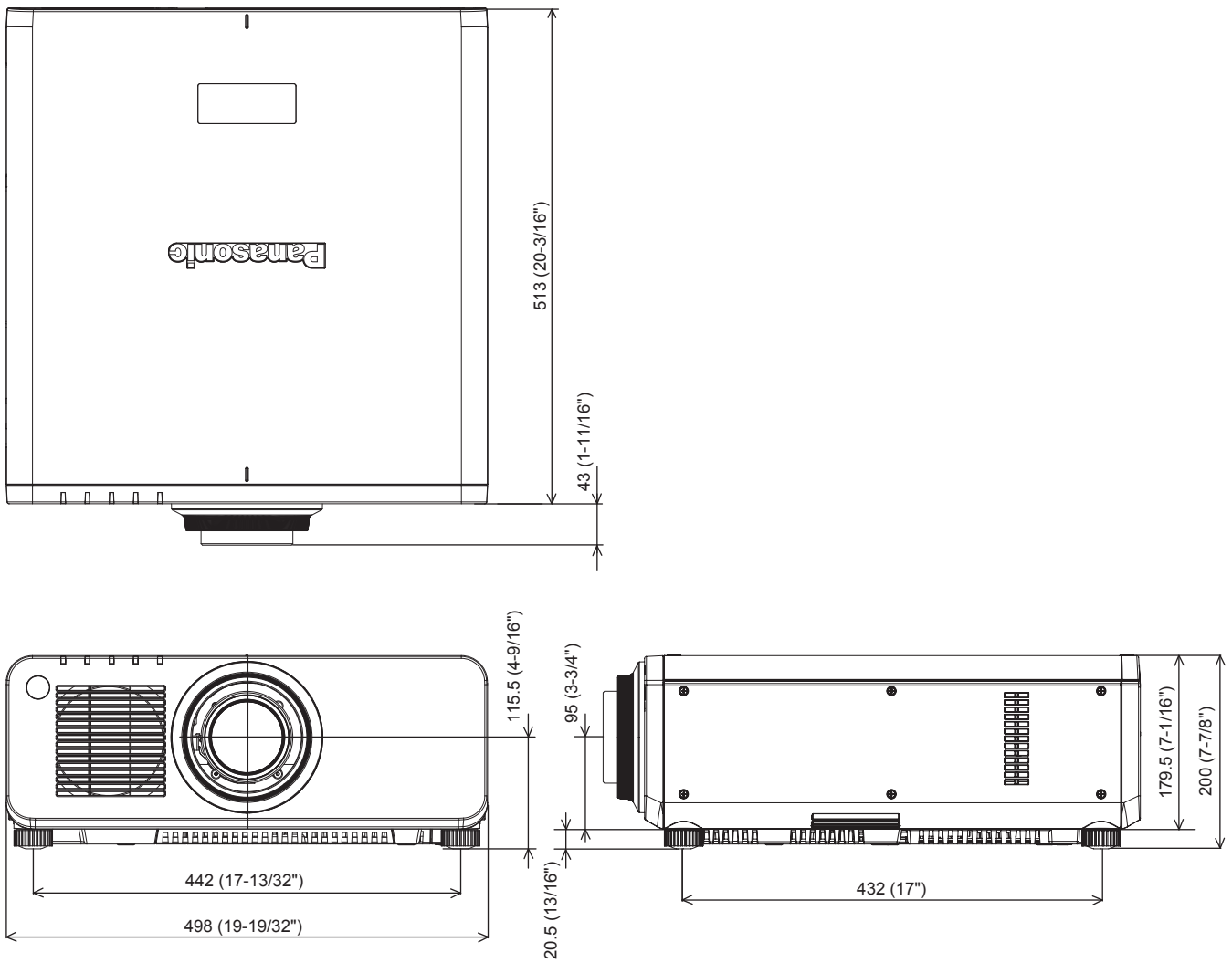

- \* The above dimensions are obtained when the standard zoom lens is attached.
- \* Actual dimensions may differ depending on the product.

# Precautions for Ceiling Mount Bracket

- When installing the projector to a ceiling, be sure to use the specified optional Ceiling Mount Bracket (Model No.: ET-PKD120H (for high ceilings), ET-PKD120S (for low ceilings), ET-PKD120B (Projector Mount Bracket)). Ceiling Mount Bracket (Model No.: ET-PKD120H (for high ceilings), ET-PKD120S (for low ceilings)) is used in combination with Ceiling Mount Bracket (Model No.: ET-PKD120B (Projector Mount Bracket)).
- When installing the projector, attach the drop-prevention kit included with the Ceiling Mount Bracket. When the drop-prevention kit (Service Model No.: TTRA0214) is necessary, consult your dealer.
- Ask a qualified technician to do the installation work such as mounting the projector on the ceiling.
- Panasonic takes no responsibility for any damage to the projector resulting from use of a ceiling mount bracket not manufactured by Panasonic or the inappropriate choice of location for installation, even if the warranty period of the projector has not expired.
- Unused products must be removed promptly by a qualified technician.
- Use a torque screwdriver or Allen torque wrench to tighten bolts to their specified tightening torques. Do not use electric screwdrivers or impact screwdrivers.
- Read the Installation Instructions for the Ceiling Mount Bracket for details.
- The model numbers of accessories and optional accessories are subject to change without prior notice.

Bottom view

Model No. of Ceiling Mount Bracket: ET-PKD120H (for high ceilings)

ET-PKD120S (for low ceilings)

ET-PKD120B (Projector Mount Bracket)

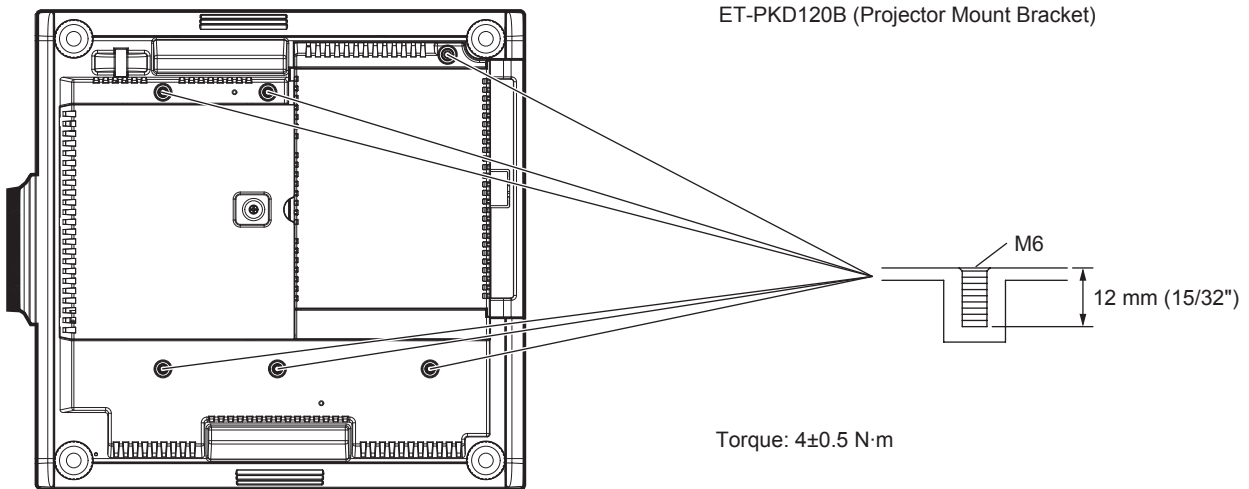

## Index

## 0 – 9

[3D 24Hz IMAGE POSITION]	92
[3D 24Hz IMAGE PROJECTION]	92
[3D FRAME DELAY]	93
[3D INPUT FORMAT]	91
[3D SAFETY PRECAUTIONS]	94
[3D SETTINGS]	68, 90
[3D SIMUL INPUT SETTING]	91
[3D SYNC SETTING]	90
[3D SYSTEM SETTING]	90
[3D TEST MODE]	93
[3D TEST PATTERN]	93

## A

Accessories	20
<AC IN> terminal	27, 54
Adjusting adjustable feet	46
[ADVANCED MENU]	67, 84
Air filter	159
Art-Net	18, 168
[Art-Net SETUP]	136
[ASPECT]	78
Automatic setup function	63
[AUTO SETUP]	97
<AUTO SETUP> button	
Projector body	27, 63
Remote control	25, 63
[AUTO SIGNAL]	97

## B

[BACK COLOR]	103
[BLANKING]	84
[BRIGHTNESS]	71
[BRIGHTNESS CONTROL]	111

## C

Cautions on use	19
Cautions when installing	16
Cautions when transporting	16
Ceiling Mount Bracket	187
[CLAMP POSITION]	85
[CLOCK PHASE]	80
[CLOSED CAPTION SETTING]	102
[COLOR]	72
[COLOR CORRECTION]	96
[COLOR MATCHING]	95
[COLOR TEMPERATURE]	72
Connecting the power cord	54
Connecting to the projector with a cable	30
Connection	49
[CONTRAST]	71
[CONTROL DEVICE PASSWORD CHANGE]	133
[CONTROL DEVICE SETUP]	131
[COOLING CONDITION]	109
Crestron RoomView	137, 153
[CUT OFF]	106

## D

[DATE AND TIME]	121
<DEFAULT> button	
Remote control	25, 66
Deleting the registered signal	127
[DIGITAL CINEMA REALITY]	84
[DIGITAL INTERFACE BOX]	136
DIGITAL LINK	18
<DIGITAL LINK> button	
Projector body	27, 62
Remote control	25, 62
[DIGITAL LINK IN]	99
[DIGITAL LINK MODE]	134
[DIGITAL LINK SETUP]	134
[DIGITAL LINK STATUS]	135
Dimensions	186
Display language	68, 89
[DISPLAY OPTION]	68, 95
[DISPLAY SETTING]	131
Disposal	18
[DLP Link]	90
<DVI-D> button	
Projector body	27, 62
Remote control	25, 62
[DVI-D IN]	98
[DYNAMIC IRIS]	75

## E

[EDGE BLENDING]	86
<ENTER> button	
Projector body	27
Remote control	25

Expanding signal lock-in range	128
--------------------------------	-----

## F

Filter indicator	157
<FOCUS> button	
Remote control	25, 58
[FRAME LOCK]	88
[FRAME RESPONSE]	87
[FREEZE]	105
Function button	63
<FUNCTION> button	
Remote control	25, 63
[FUNCTION BUTTON]	121

## G

[GAMMA]	74
[GEOMETRY(2D)]	80

## H

<HDMI> button	
Projector body	27, 62
Remote control	25, 62
[HDMI IN]	99
[HIGH ALTITUDE MODE]	109

## I

<ID SET> button	
Remote control	25, 29
[INITIALIZE]	123
Initial setting	22
[INPUT RESOLUTION]	85
Installation mode	32

## K

[KEYSTONE]	83
[KEYSTONE(3D)]	82

## L

Lamp indicator	157
[LAMP POWER]	111
[LAMP RELAY]	110
[LAMP SELECT]	109
Lamp unit cover	26
[LEFT/RIGHT SWAP]	92
<LENS> button	
Projector body	27
Remote control	25, 62
[LENS CALIBRATION]	122
List of compatible signals	178
[LOAD ALL USER DATA]	123

## M

Main menu	66
Main power switch	27, 55
Maintenance	159
<MENU> button	
Projector body	27, 65
Remote control	25, 65
Menu item	67

## N

Navigating through the menu	65
[NETWORK]	70, 134
Network connections	137
[NETWORK CONTROL]	136
[NETWORK SETUP]	135
[NETWORK STATUS]	136
[NOISE REDUCTION]	75
[NO SIGNAL SHUT-OFF]	120

## O

<ON SCREEN> button	
Remote control	25, 61
[ON-SCREEN DISPLAY]	101
On-screen menu	65
Optional accessories	21

## P

[PICTURE]	67, 71
[PICTURE MODE]	71
[P IN P]	69, 124
P IN P function	124
[POSITION]	67, 78
Power cord	54
Power indicator	54
Power on button	
Projector body	27
Remote control	25

Power standby button	
Projector body	27
Remote control	25
Precautions for Ceiling Mount Bracket	187
Precautions for use	16
Projecting	58
[PROJECTION METHOD]	108
Projector body	26
[PROJECTOR ID]	108
[PROJECTOR SETUP]	69, 108
Protecting the registered signal	128

## R

[RASTER POSITION]	88
Read this first!	2
Registering new signals	127
<REMOTE 1 IN> terminal	28
<REMOTE 1 OUT> terminal	28
<REMOTE 2 IN> terminal	176
[REMOTE2 MODE]	121
Remote control	25
Remote control operations	61
Removing/attaching the projection lens	47
Renaming the registered signal	127
Replacing the air filter unit	162
Replacing the lamp unit	160
Replacing the unit	160
Resetting to the factory default	66
<RGB1/2> button	
Remote control	25, 62
<RGB1/RGB2> button	
Projector body	27, 62
[RGB IN]	98
RoomView	153
[RS-232C]	118, 171

## S

[SAFETY PRECAUTIONS MESSAGE]	94
[SAVE ALL USER DATA]	122
[SCHEDULE]	116
[SCREEN SETTING]	96
<SDI> button	
Projector body	27, 62
Remote control	25, 62
[SDI IN]	100
Security	18
[SECURITY]	69, 130
[SECURITY PASSWORD]	130
[SECURITY PASSWORD CHANGE]	130
Selecting the input signal	58
<SERIAL IN> terminal	171
<SERIAL OUT> terminal	171
[SERVICE PASSWORD]	123
Setting remote control ID numbers	29
Setting up	32
[SHARPNESS]	75
[SHIFT]	78
<SHIFT> button	
Remote control	25, 58
<SHUTTER> button	
Projector body	27, 61
Remote control	25, 61
[SHUTTER SETTING]	104
[SIGNAL LIST]	69, 127
Specifications	183
sRGB-compliant video	77
[STANDBY MODE]	116
[STARTUP INPUT SELECT]	117
[STARTUP LOGO]	103
[STATUS]	119
<STATUS> button	
Remote control	25, 62
[SUB CLOCK PHASE]	93
Sub memory	129
Switching off the projector	57
Switching on the projector	55
Switching the input signal	62
[SYSTEM DAYLIGHT VIEW]	74
[SYSTEM SELECTOR]	76

## T

Temperature indicator	157
[TEST PATTERN]	69, 126
<TEST PATTERN> button	
Remote control	25, 63
[TEXT CHANGE]	131
[TINT]	72
Troubleshooting	164
Two window	177



**U**

[UNIFORMITY].....103  
Upgrade Kit.....178

**V**

<VIDEO> button  
Projector body.....27, 62  
Remote control.....25, 62

**W**

[WAVEFORM MONITOR].....105  
[WHITE GAIN].....74

**Z**

[ZOOM].....79  
<ZOOM> button  
Remote control.....25, 58

## Information for Users on Collection and Disposal of Old Equipment and used Batteries



These symbols on the products, packaging, and/or accompanying documents mean that used electrical and electronic products and batteries should not be mixed with general household waste. For proper treatment, recovery and recycling of old products and used batteries, please take them to applicable collection points, in accordance with your national legislation and the Directives 2002/96/EC and 2006/66/EC.

By disposing of these products and batteries correctly, you will help to save valuable resources and prevent any potential negative effects on human health and the environment which could otherwise arise from inappropriate waste handling.



For more information about collection and recycling of old products and batteries, please contact your local municipality, your waste disposal service or the point of sale where you purchased the items.

Penalties may be applicable for incorrect disposal of this waste, in accordance with national legislation.



### **For business users in the European Union**

If you wish to discard electrical and electronic equipment, please contact your dealer or supplier for further information.

### **Information on Disposal in other Countries outside the European Union**

These symbols are only valid in the European Union. If you wish to discard these items, please contact your local authorities or dealer and ask for the correct method of disposal.

### **Note for the battery symbol (bottom two symbol examples):**

This symbol might be used in combination with a chemical symbol. In this case it complies with the requirement set by the Directive for the chemical involved.